

CONTENTS

COMPANY INFORMATION

Company Profile • Contact Information • Warranty

BALL VALVES

3/16" to 1" (4.7 to 25.4 mm) Ports • Pressures to 20,000 PSI (1380 bar)
2-way, 3-way, 4-way and 5-way valves • Pneumatic Actuators • Electric Actuators

PIPE EQUIPMENT

1/8" to 1" Pipe Sizes • Pressures to 15,000 PSI (1030 bar)
Needle Valves • Metering Valves • Manifold Valves • Check Valves • Filters • Safety Heads • Rupture Discs
Elbows • Tees • Crosses • Nipples • Adapters • Couplings • Bulkheads • Zero-Clearance Unions

LOW PRESSURE EQUIPMENT

1/16" to 1/2" Tube Sizes • Pressures to 15,000 PSI (1030 bar)
Needle Valves • Metering Valves • Check Valves • Filters • Safety Heads • Rupture Discs • Elbows
Tees • Crosses • Couplings • Bulkheads • Tubing

MEDIUM PRESSURE EQUIPMENT

1/4" to 1" Tube Sizes • Pressures to 20,000 PSI (1380 bar)
Needle Valves • Metering Valves • Check Valves • Filters • Safety Heads • Rupture Discs • Elbows
Tees • Crosses • Couplings • Bulkheads • Tubing • Anti-Vibration Collet Glands

HIGH PRESSURE EQUIPMENT

1/4" to 1" Tube Sizes • Pressures to 150,000 PSI (10,340 bar)
Needle Valves • Metering Valves • Check Valves • Filters • Safety Heads • Rupture Discs • Elbows
Tees • Crosses • Couplings • Bulkheads • Tubing • Anti-Vibration Collet Glands

SPECIALTY PRODUCTS

Manifolds • Custom-Designed Valves • Swivel Joints

ACTUATORS

Pneumatic or Hydraulic Actuators for Remote Control of BuTech Needle Valves

ADAPTERS, COUPLINGS & ACCESSORIES

Adapters • Couplings • High Pressure Hose Assemblies • Thermocouples • Pressure Gauges • Gauge Snubbers

SOUR GAS EQUIPMENT

1/4" to 9/16" Tube Sizes • Pressures to 30,000 PSI (2070 bar)
Needle Valves • Check Valves • Filters • Safety Heads • Rupture Discs • Elbows • Tees • Crosses • Couplings
Bulkheads • Tubing • Anti-Vibration Collet Glands

TOOLS & INSTALLATION

Installation Instructions • Coning Tools • Threading Tools • Tube Bender • Tube Vises

TECHNICAL INFORMATION

Conversion Tables • Flow Formulas • Effects of Material Type on Pressure Rating • Pressure Drop Curves
Pressure vs Bend Radius Curves • Pressure vs Temperature Curves • Pressure/Temperature Rating Guide



...for the Peak of Performance



AN INTRODUCTION TO BUtech BALL VALVES

BuTech ball valves are available in 2-, 3-, 4- and 5-way designs with an infinite combination of connections including male and female NPT, low-pressure compression fittings, medium- and high-pressure tube ends, medium- and high-pressure female, JIC 37° flare, SAE O-ring boss, socket-weld, butt-weld, and metric connections. They are available with special seal materials or manufactured from any machinable metal for extreme applications. They can also be fitted with pneumatic or electric actuators for remote control.

Features:

- Pressures to 20,000 PSI (1380 bar) at 72°F (22°C)
- Pressure loaded seats assure positive sealing
- Blowout-proof stem and ball provides maximum safety
- Choice of replaceable connections for installation versatility
- Straight-through flow path minimizes pressure drop
- Quarter-turn operation accommodates quick open and close needs
- Flow indicating handle indicates valve position at a glance
- Bi-directional flow capabilities

Applications:

All types of instrumentation	Chemical research
Laboratories	Food processing
Refineries	Pilot plants
Hydraulic and pneumatic piping	Water blasting
Chromatography	Gas analysis
Gauge shut-off and vent	Test Stands
Control panels	Moderate vacuum systems
High purity systems	Down-hole control systems on off-shore drilling platforms

Materials of Construction:

Standard materials of construction include 316 cold-worked stainless steel, 17-4PH, PEEK, Viton, virgin te-flon and glass-filled teflon. These valves may also be produced in any machinable metal with special seal materials. Please consult factory.

Selecting the Proper Ball Type

BuTech ball valves offer a variety of flow configurations. See page BV-20 for additional information.

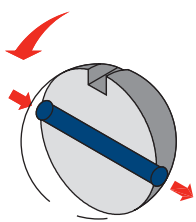

2-way

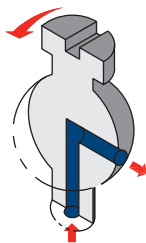

3-way & 5-way

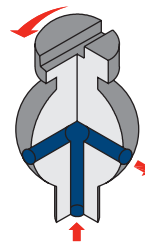

3-way

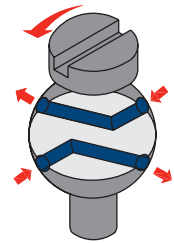

4-way

***CAUTION:** The maximum allowable working pressure (MAWP) of the valve does not exceed the MAWP of the series or the selected connection, whichever is less.



All dimensions are for reference only and are subject to change.
Dimensions in parentheses are millimeters (mm).

ORDERING INFORMATION

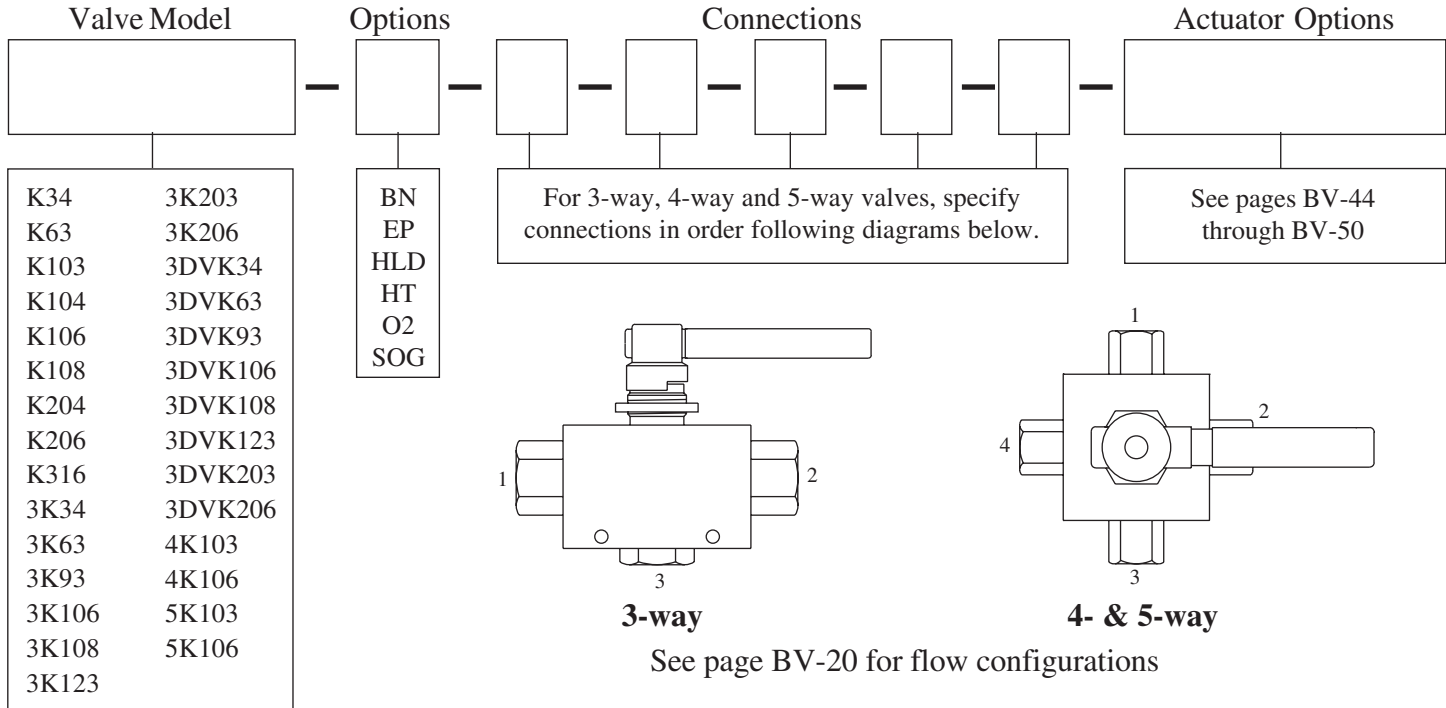

Examples:

A 2-way valve with 0.250" port, 10,000 PSI with 3/8" female NPT connections and Buna-N o-rings
K104-BN-21-21

A 2-way valve with 0.375" port, 20,000 PSI with 1/2" female NPT and 9/16" male M/P coned-and-threaded connections and double-acting pneumatic actuator
K206-22-11-RA05DA

A 3-way valve for switching service with 0.500" port, 10,000 PSI with 1/2" female NPT side connections and 3/4" male NPT bottom connection for high-temperature service
3K108-HT-22-22-55B

A 4-way valve with 0.187" port, 10,000 PSI with (2) 1/4" FNPT connections and (2) 3/8" FNPT connections
4K103-20-20-21-21

Options:

- BN** Buna-N o-rings
- EP** EPR o-rings
- HLD** Handle locking device (prevents unauthorized opening/closing of valve)
- HT** High-temperature o-rings for continuous service to 550°F (288°C)
- O2** Cleaned for oxygen service
- SOG** For Sour Gas service in accordance with NACE MR-01-75

BuTech ball valves may be manufactured from any machinable metal and fitted with special seal materials. Please consult factory for information.

All dimensions are for reference only and are subject to change.
 Dimensions in parentheses are millimeters (mm).

BALL VALVE LOCATOR

	Model No.	Maximum Pressure*	Port	Cv	Page
2-way Valves for On-Off Service	K34	3,000 PSI 210 bar	0.250" (6.4)	1.40	BV-4
	K316	3,000 PSI 210 bar	1.000" (25.4)	36.00	BV-5
	K63	6,000 PSI 410 bar	0.187" (4.7)	0.75	BV-6
	K103	10,000 PSI 690 bar	0.187" (4.7)	0.75	BV-8
	K104	10,000 PSI 690 bar	0.250" (6.4)	1.40	BV-10
	K106	10,000 PSI 690 bar	0.375" (9.5)	3.40	BV-12
	K108	10,000 PSI 690 bar	0.500" (12.7)	10.00	BV-14
	K204	20,000 PSI 1380 bar	0.250" (6.4)	1.40	BV-16
	K206	20,000 PSI 1380 bar	0.375" (9.5)	3.40	BV-18
3-way Valves for Switching Service	3K34	3,000 PSI 210 bar	0.250" (6.4)	1.00	BV-21
	3K63	6,000 PSI 410 bar	0.187" (4.7)	0.56	BV-22
	3K93	10,000 PSI 690 bar	0.187" (4.7)	0.56	BV-24
	3K106	10,000 PSI 690 bar	0.375" (9.5)	2.40	BV-26
	3K108	10,000 PSI 690 bar	0.500" (12.7)	5.00	BV-28
	3K123	12,000 PSI 830 bar	0.187" (4.7)	0.56	BV-30
	3K203	20,000 PSI 1380 bar	0.187" (4.7)	0.56	BV-32
	3K206	20,000 PSI 1380 bar	0.375" (9.5)	2.40	BV-34
3-way Valves for Diverting Service	3DVK34	3,000 PSI 210 bar	0.250" (6.4)	1.00	BV-21
	3DVK63	6,000 PSI 410 bar	0.187" (4.7)	0.56	BV-22
	3DVK93	10,000 PSI 690 bar	0.187" (4.7)	0.56	BV-24
	3DVK106	10,000 PSI 690 bar	0.375" (9.5)	2.40	BV-26
	3DVK108	10,000 PSI 690 bar	0.500" (12.7)	5.00	BV-28
	3DVK123	12,000 PSI 830 bar	0.187" (4.7)	0.56	BV-30
	3DVK203	20,000 PSI 1380 bar	0.187" (4.7)	0.56	BV-32
	3DVK206	20,000 PSI 1380 bar	0.375" (9.5)	2.40	BV-34
4-way & 5-way Valves	4K103	10,000 PSI 690 bar	0.187" (4.7)	0.56	BV-36
	5K103	10,000 PSI 690 bar	0.187" (4.7)	0.56	BV-40
	4K106	10,000 PSI 690 bar	0.375" (9.5)	2.40	BV-38
	5K106	10,000 PSI 690 bar	0.375" (9.5)	2.40	BV-42

NOTE: Standard operating temperature range is -20 to 400° F (-28 to 204°C). For applications requiring higher temperatures, select the **-HT** option shown on page BV-2.

***CAUTION:** The maximum allowable working pressure (MAWP) of the valve shall not exceed the MAWP of the valve series or the selected connection, whichever is less.



All dimensions are for reference only and are subject to change.
Dimensions in parentheses are millimeters (mm).

3000 PSI (210 BAR) 2-WAY BALL VALVES

Model No. K34

Mounting:

Panel: 0.78" (19.8 mm) dia
0.37" (9.4 mm) max thickness

*MAWP: 3,000 PSI (210 bar)
Port: 0.250" (6.4 mm)
Cv: 1.40

Materials of Construction:

- 316 cold-worked stainless steel body and side adapters
- 316 cold-worked stem
- PEEK ball seals
- Glass-filled Teflon stem packings
- Viton O-rings

Ordering information and options on page BV-2

Repair Kit P/N RK-K34 contains ball, ball seals and seal retainers, o-rings, pins, stem, stem packings, and washers

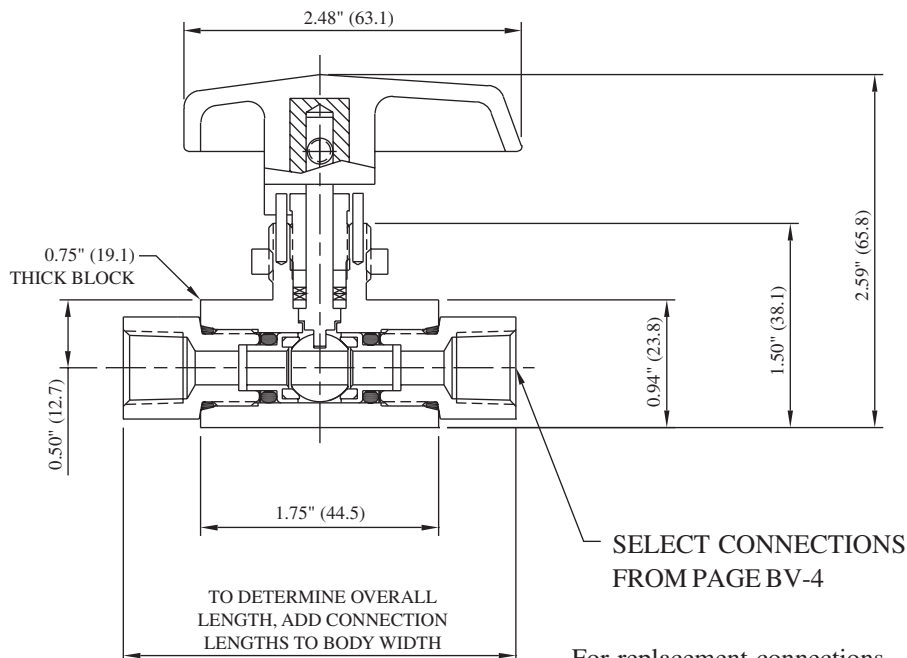

For replacement connections, use prefix number **40-** and suffix number. Ex: 40-20

FEMALE PIPE

Connection	Suffix	Hex	Length	Port	MAWP*
1/8" FNPT	19	0.75" (19.1)	0.58" (14.7)	0.250" (6.4)	15,000 PSI 1030 bar
1/4" FNPT	20	0.75" (19.1)	0.58" (14.7)	0.250" (6.4)	15,000 PSI 1030 bar
3/8" FNPT	21	1.00" (25.4)	0.75" (19.1)	0.250" (6.4)	15,000 PSI 1030 bar
1/2" FNPT	22	1.18" (30.0)	1.00" (25.4)	0.250" (6.4)	15,000 PSI 1030 bar

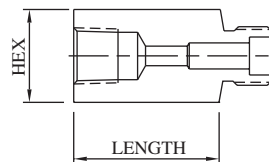

MALE PIPE

Connection	Suffix	Hex	Length	Port	MAWP*
1/8" MNPT	4	0.75" (19.1)	0.97" (24.6)	0.250" (6.4)	15,000 PSI 1030 bar
1/4" MNPT	5	0.75" (19.1)	1.19" (30.2)	0.250" (6.4)	15,000 PSI 1030 bar
3/8" MNPT	6	1.00" (25.4)	1.30" (33.0)	0.250" (6.4)	15,000 PSI 1030 bar
1/2" MNPT	7	1.00" (25.4)	1.55" (39.4)	0.250" (6.4)	15,000 PSI 1030 bar

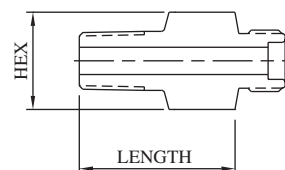

***CAUTION:** The maximum allowable working pressure (MAWP) of the valve shall not exceed the MAWP of the valve series or the selected connection, whichever is less.

All dimensions are for reference only and are subject to change.
Dimensions in parentheses are millimeters (mm).



3000 PSI (210 BAR) 2-WAY BALL VALVES

Mounting:

Side: 0.47" (11.9 mm) dia

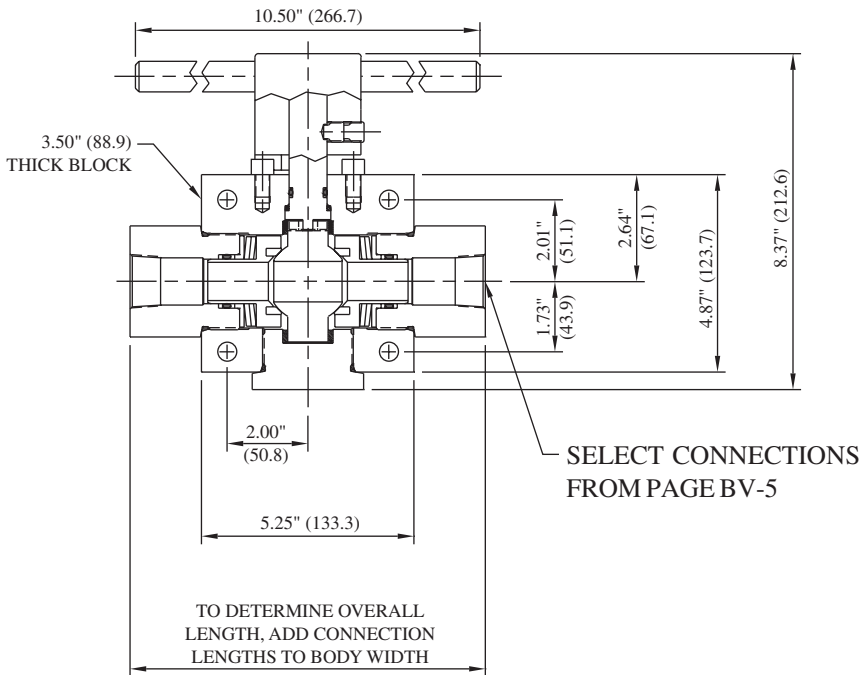

For replacement connections, use prefix number **160-** and suffix number. Ex: 160-20

Model No. K316

*MAWP: 3,000 PSI (210 bar)
 Port: 1.000" (25.4 mm)
 Cv: 36.00

Materials of Construction:

- 316 cold-worked stainless steel body and side adapters
- 17-4PH stem
- PEEK ball seals
- Viton O-rings
- Teflon back-ups

Ordering information and options on page BV-2

Repair Kit P/N RK-K316 contains stem, ball, ball seals and seal retainers, o-rings, spring washers, and bearing washers

FEMALE PIPE

Connection	Suffix	Hex	Length	Port	MAWP*
3/4" FNPT	41	2.75" (69.9)	1.05" (26.7)	0.922" (23.4)	10,000 PSI 690 bar
1" FNPT	45	2.75" (69.9)	1.22" (31.0)	1.102" (28.0)	10,000 PSI 690 bar
1-1/2" FNPT	46	2.75" (69.9)	1.63" (41.4)	1.102" (28.0)	5,000 PSI 340 bar

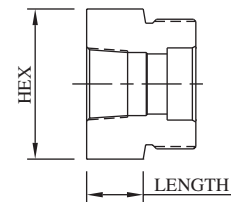

MALE PIPE

Connection	Suffix	Hex	Length	Port	MAWP*
3/4" MNPT	55	2.75" (69.9)	1.82" (46.2)	0.625" (15.9)	10,000 PSI 690 bar
1" MNPT	56	2.75" (69.9)	2.03" (51.6)	0.687" (17.4)	10,000 PSI 690 bar
1-1/2" MNPT	121	2.75" (69.9)	1.96" (49.8)	1.102" (28.0)	5,000 PSI 340 bar

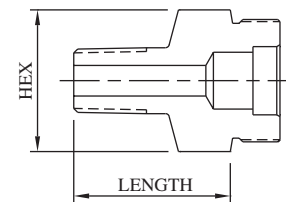

***CAUTION:** The maximum allowable working pressure (MAWP) of the valve shall not exceed the MAWP of the valve series or the selected connection, whichever is less.

All dimensions are for reference only and are subject to change.
 Dimensions in parentheses are millimeters (mm).



6000 PSI (410 BAR) 2-WAY BALL VALVES

Model No. K63

Mounting:

Panel: 0.91" (23.0 mm) dia
0.31" (7.8 mm) max thickness

*MAWP: 6,000 PSI (410 bar)
Port: 0.187" (4.7 mm)
Cv: 0.75

Materials of Construction:

- 316 cold-worked stainless steel body and side adapters
- 316 cold-worked stem
- PEEK ball seals
- Glass-filled Teflon stem packings
- Viton O-rings

Ordering information and options on page BV-2

Repair Kit P/N RK-K63 contains ball, ball seals and seal retainers, o-rings, spring washers, stem, stem packings, and washers

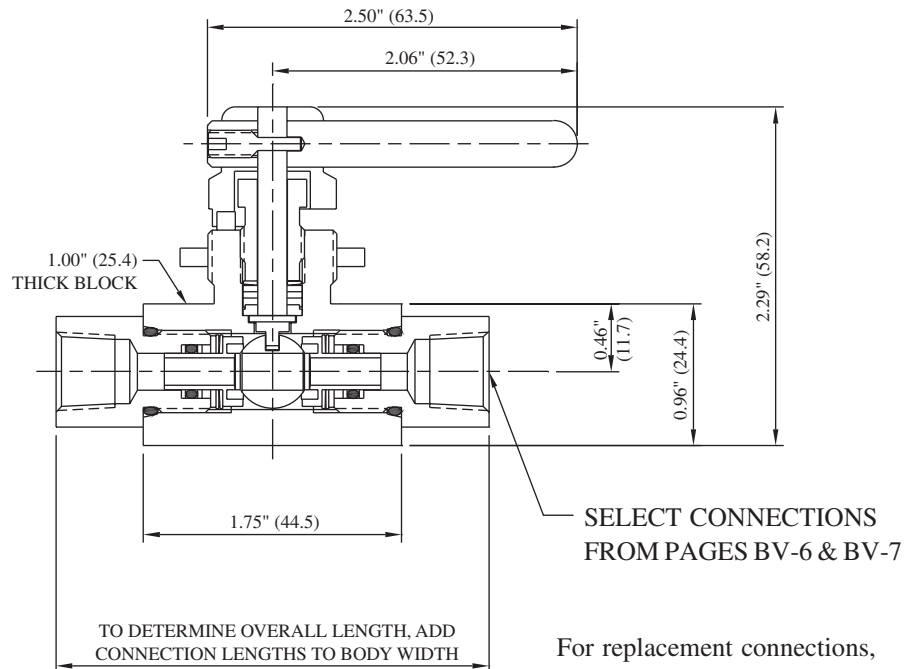

SELECT CONNECTIONS FROM PAGES BV-6 & BV-7

For replacement connections, use prefix number **3-** and suffix number. Ex: 3-20

FEMALE PIPE

Connection	Suffix	Hex	Length	Port	MAWP*
1/8" FNPT	19	0.75" (19.1)	0.60" (15.2)	0.250" (6.4)	15,000 PSI 1030 bar
1/4" FNPT	20	0.75" (19.1)	0.60" (15.2)	0.250" (6.4)	15,000 PSI 1030 bar
3/8" FNPT	21	1.00" (25.4)	1.01" (25.7)	0.250" (6.4)	15,000 PSI 1030 bar
1/2" FNPT	22	1.00" (25.4)	1.01" (25.7)	0.250" (6.4)	15,000 PSI 1030 bar

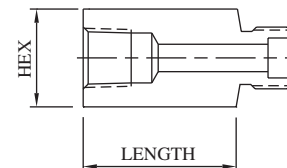

MALE PIPE

Connection	Suffix	Hex	Length	Port	MAWP*
1/8" MNPT	4	0.75" (19.1)	1.01" (25.7)	0.125" (3.2)	15,000 PSI 1030 bar
1/4" MNPT	5	0.75" (19.1)	1.01" (25.7)	0.250" (6.4)	15,000 PSI 1030 bar
3/8" MNPT	6	0.75" (19.1)	1.01" (25.7)	0.250" (6.4)	15,000 PSI 1030 bar
1/2" MNPT	7	1.00" (25.4)	1.26" (32.0)	0.250" (6.4)	15,000 PSI 1030 bar

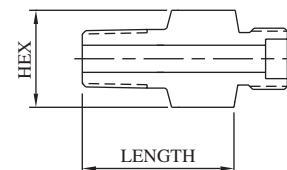

***CAUTION:** The maximum allowable working pressure (MAWP) of the valve shall not exceed the MAWP of the valve series or the selected connection, whichever is less.

All dimensions are for reference only and are subject to change.
Dimensions in parentheses are millimeters (mm).



6000 PSI (410 BAR) 2-WAY BALL VALVES

Model No. K63

FEMALE SINGLE-FERRULE TUBE

Connection	Suffix	Hex	Length	Port	MAWP*
1/8" L/P	12	0.75" (19.1)	0.78" (19.8)	0.093" (2.4)	15,000 PSI 1030 bar
1/4" SL/P	13	0.75" (19.1)	1.03" (26.2)	0.125" (3.2)	11,500 PSI 790 bar
3/8" SL/P	14	0.75" (19.1)	1.03" (26.2)	0.250" (6.4)	7,500 PSI 520 bar
1/2" L/P	15	1.00" (25.4)	1.03" (26.2)	0.250" (6.4)	5,500 PSI 380 bar

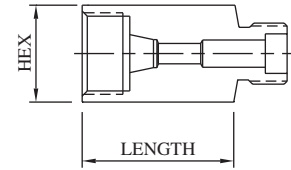

FEMALE M/P CONED AND THREADED TUBE

Connection	Suffix	Hex	Length	Port	MAWP*
1/4" M/P	16	0.75" (19.1)	0.74" (18.8)	0.109" (2.8)	20,000 PSI 1380 bar
3/8" M/P	17	0.75" (19.1)	1.01" (25.7)	0.203" (5.2)	20,000 PSI 1380 bar
9/16" M/P	18	1.00" (25.4)	1.26" (32.0)	0.250" (6.4)	20,000 PSI 1380 bar

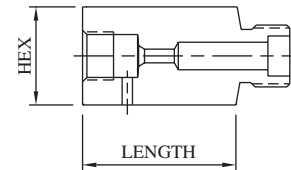

MALE M/P CONED AND THREADED TUBE

Connection	Suffix	Hex	Length	Port	MAWP*
1/4" M/P	8	0.75" (19.1)	1.88" (47.8)	0.109" (2.8)	20,000 PSI 1380 bar
3/8" M/P	10	0.75" (19.1)	2.00" (50.8)	0.203" (5.2)	20,000 PSI 1380 bar
9/16" M/P	11	1.00" (25.4)	2.31" (58.7)	0.250" (6.4)	20,000 PSI 1380 bar

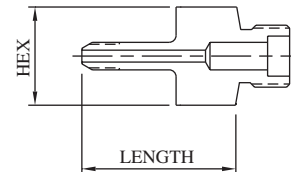

FEMALE H/P CONED AND THREADED TUBE

Connection	Suffix	Hex	Length	Port	MAWP*
1/4" H/P	23	0.75" (19.1)	1.01" (25.7)	0.093" (2.4)	20,000 PSI 1380 bar
3/8" H/P	24	1.00" (25.4)	1.17" (29.7)	0.125" (3.2)	20,000 PSI 1380 bar
9/16" H/P	25	1.37" (34.8)	1.25" (31.8)	0.187" (4.7)	20,000 PSI 1380 bar

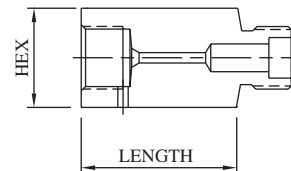

MALE H/P CONED AND THREADED TUBE

Connection	Suffix	Hex	Length	Port	MAWP*
1/4" H/P	9	0.75" (19.1)	1.94" (49.3)	0.083" (2.1)	20,000 PSI 1380 bar
3/8" H/P	30	0.75" (19.1)	2.25" (57.2)	0.125" (3.2)	20,000 PSI 1380 bar
9/16" H/P	42	0.75" (19.1)	2.82" (71.6)	0.187" (4.7)	20,000 PSI 1380 bar

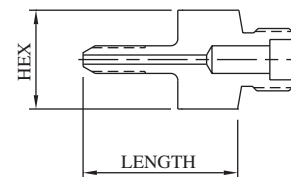

***CAUTION:** The maximum allowable working pressure (MAWP) of the valve shall not exceed the MAWP of the valve series or the selected connection, whichever is less.



All dimensions are for reference only and are subject to change.
Dimensions in parentheses are millimeters (mm).

10,000 PSI (690 BAR) 2-WAY BALL VALVES

Model No. K103

Mounting:

Panel: 0.91" (23.0 mm) dia
0.31" (7.8 mm) max thickness

*MAWP: 10,000 PSI (690 bar)
Port: 0.187" (4.7 mm)
Cv: 0.75

Materials of Construction:

- 316 cold-worked stainless steel body and side adapters
- 316 cold-worked stem
- PEEK ball seals
- Glass-filled Teflon stem packings
- Viton O-rings

Ordering information and options on page BV-2

Repair Kit P/N RK-K103 contains ball, ball seals and seal retainers, o-rings, spring washers, stem, stem packings, and washers

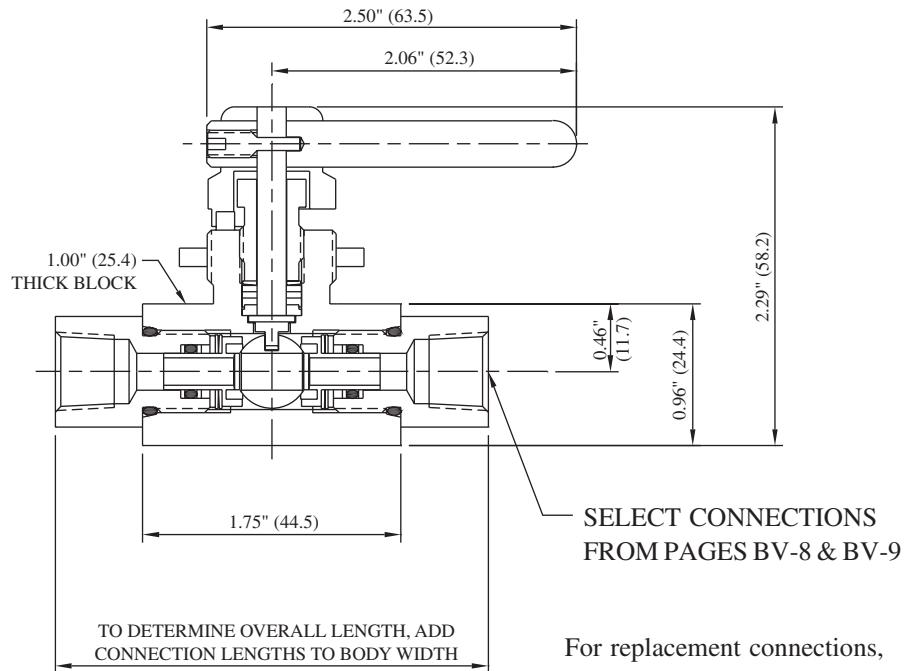

For replacement connections, use prefix number **3-** and suffix number. Ex: 3-20

FEMALE PIPE

Connection	Suffix	Hex	Length	Port	MAWP*
1/8" FNPT	19	0.75" (19.1)	0.60" (15.2)	0.250" (6.4)	15,000 PSI 1030 bar
1/4" FNPT	20	0.75" (19.1)	0.60" (15.2)	0.250" (6.4)	15,000 PSI 1030 bar
3/8" FNPT	21	1.00" (25.4)	1.01" (25.7)	0.250" (6.4)	15,000 PSI 1030 bar
1/2" FNPT	22	1.00" (25.4)	1.01" (25.7)	0.250" (6.4)	15,000 PSI 1030 bar

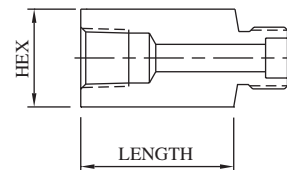

MALE PIPE

Connection	Suffix	Hex	Length	Port	MAWP*
1/8" MNPT	4	0.75" (19.1)	1.01" (25.7)	0.125" (3.2)	15,000 PSI 1030 bar
1/4" MNPT	5	0.75" (19.1)	1.01" (25.7)	0.250" (6.4)	15,000 PSI 1030 bar
3/8" MNPT	6	0.75" (19.1)	1.01" (25.7)	0.250" (6.4)	15,000 PSI 1030 bar
1/2" MNPT	7	1.00" (25.4)	1.26" (32.0)	0.250" (6.4)	15,000 PSI 1030 bar

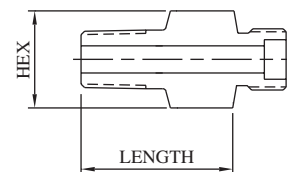

***CAUTION:** The maximum allowable working pressure (MAWP) of the valve shall not exceed the MAWP of the valve series or the selected connection, whichever is less.

All dimensions are for reference only and are subject to change.
Dimensions in parentheses are millimeters (mm).



10,000 PSI (690 BAR) 2-WAY BALL VALVES

Model No. K103

FEMALE SINGLE-FERRULE TUBE

Connection	Suffix	Hex	Length	Port	MAWP*
1/8" L/P	12	0.75" (19.1)	0.78" (19.8)	0.093" (2.4)	15,000 PSI 1030 bar
1/4" SL/P	13	0.75" (19.1)	1.03" (26.2)	0.125" (3.2)	11,500 PSI 790 bar
3/8" SL/P	14	0.75" (19.1)	1.03" (26.2)	0.250" (6.4)	7,500 PSI 520 bar
1/2" L/P	15	1.00" (25.4)	1.03" (26.2)	0.250" (6.4)	5,500 PSI 380 bar

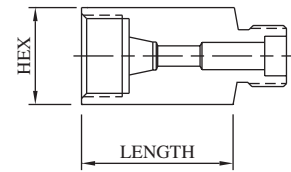

FEMALE M/P CONED AND THREADED TUBE

Connection	Suffix	Hex	Length	Port	MAWP*
1/4" M/P	16	0.75" (19.1)	0.74" (18.8)	0.109" (2.8)	20,000 PSI 1380 bar
3/8" M/P	17	0.75" (19.1)	1.01" (25.7)	0.203" (5.2)	20,000 PSI 1380 bar
9/16" M/P	18	1.00" (25.4)	1.26" (32.0)	0.250" (6.4)	20,000 PSI 1380 bar

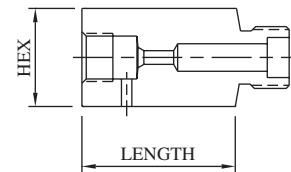

MALE M/P CONED AND THREADED TUBE

Connection	Suffix	Hex	Length	Port	MAWP*
1/4" M/P	8	0.75" (19.1)	1.88" (47.8)	0.109" (2.8)	20,000 PSI 1380 bar
3/8" M/P	10	0.75" (19.1)	2.00" (50.8)	0.203" (5.2)	20,000 PSI 1380 bar
9/16" M/P	11	1.00" (25.4)	2.31" (58.7)	0.250" (6.4)	20,000 PSI 1380 bar

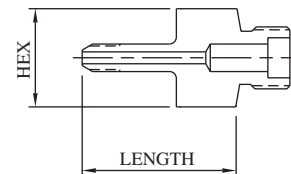

FEMALE H/P CONED AND THREADED TUBE

Connection	Suffix	Hex	Length	Port	MAWP*
1/4" H/P	23	0.75" (19.1)	1.01" (25.7)	0.093" (2.4)	20,000 PSI 1380 bar
3/8" H/P	24	1.00" (25.4)	1.17" (29.7)	0.125" (3.2)	20,000 PSI 1380 bar
9/16" H/P	25	1.37" (34.8)	1.25" (31.8)	0.187" (4.7)	20,000 PSI 1380 bar

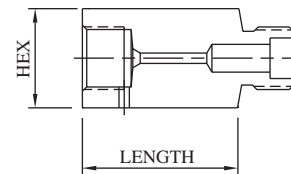

MALE H/P CONED AND THREADED TUBE

Connection	Suffix	Hex	Length	Port	MAWP*
1/4" H/P	9	0.75" (19.1)	1.94" (49.3)	0.083" (2.1)	20,000 PSI 1380 bar
3/8" H/P	30	0.75" (19.1)	2.25" (57.2)	0.125" (3.2)	20,000 PSI 1380 bar
9/16" H/P	42	0.75" (19.1)	2.82" (71.6)	0.187" (4.7)	20,000 PSI 1380 bar

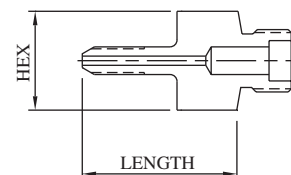

***CAUTION:** The maximum allowable working pressure (MAWP) of the valve shall not exceed the MAWP of the valve series or the selected connection, whichever is less.



All dimensions are for reference only and are subject to change.
Dimensions in parentheses are millimeters (mm).

10,000 PSI (690 BAR) 2-WAY BALL VALVES

Model No. K104

*MAWP: 10,000 PSI (690 bar)
 Port: 0.250" (6.4 mm)
 Cv: 1.40

Materials of Construction:

- 316 cold-worked stainless steel body and side adapters
- 17-4PH stem
- PEEK ball seals
- Glass-filled Teflon stem packings
- Viton O-rings

Ordering information and options on page BV-2

Repair Kit P/N RK-K104 contains ball, ball seals and seal retainers, o-rings, stem, stem packings, and washers

Mounting:

Panel: 1.06" (26.9 mm) dia
 0.43" (11.0 mm) max thickness
 Top: 1/4"-20 UNC
 Side: 0.28" (7.1 mm) dia

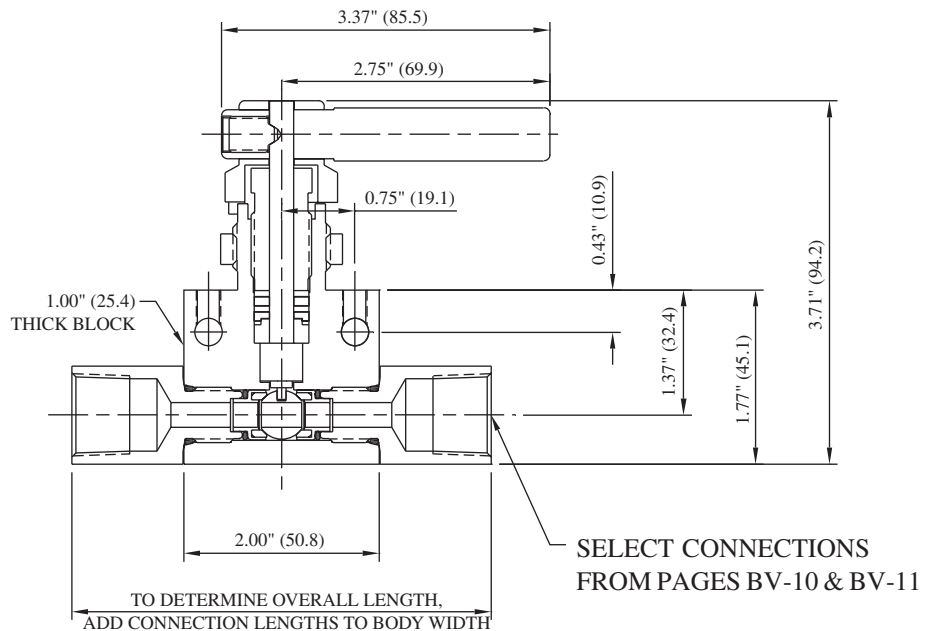

For replacement connections, use prefix number **4-** and suffix number. Ex: 4-20

FEMALE PIPE

Connection	Suffix	Hex	Length	Port	MAWP*
1/8" FNPT	19	0.75" (19.1)	1.03" (26.2)	0.250" (6.4)	15,000 PSI 1030 bar
1/4" FNPT	20	0.75" (19.1)	1.03" (26.2)	0.250" (6.4)	15,000 PSI 1030 bar
3/8" FNPT	21	1.38" (35.1)	1.03" (26.2)	0.250" (6.4)	15,000 PSI 1030 bar
1/2" FNPT	22	1.38" (35.1)	1.16" (29.5)	0.250" (6.4)	15,000 PSI 1030 bar

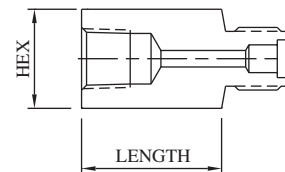

MALE PIPE

Connection	Suffix	Hex	Length	Port	MAWP*
1/8" MNPT	4	0.75" (19.1)	1.03" (26.2)	0.125" (3.2)	15,000 PSI 1030 bar
1/4" MNPT	5	0.75" (19.1)	1.03" (26.2)	0.250" (6.4)	15,000 PSI 1030 bar
3/8" MNPT	6	0.75" (19.1)	1.03" (26.2)	0.250" (6.4)	15,000 PSI 1030 bar
1/2" MNPT	7	1.00" (25.4)	1.29" (32.8)	0.250" (6.4)	15,000 PSI 1030 bar

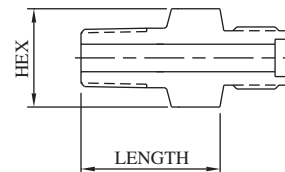

***CAUTION:** The maximum allowable working pressure (MAWP) of the valve shall not exceed the MAWP of the valve series or the selected connection, whichever is less.

All dimensions are for reference only and are subject to change.
 Dimensions in parentheses are millimeters (mm).



10,000 PSI (690 BAR) 2-WAY BALL VALVES

Model No. **K104**

FEMALE SINGLE-FERRULE TUBE

Connection	Suffix	Hex	Length	Port	MAWP*
1/8" L/P	12	0.75" (19.1)	0.78" (19.8)	0.093" (2.4)	15,000 PSI 1030 bar
1/4" SL/P	13	0.75" (19.1)	1.03" (26.2)	0.125" (3.2)	11,500 PSI 790 bar
3/8" SL/P	14	0.75" (19.1)	1.03" (26.2)	0.250" (6.4)	7,500 PSI 520 bar
1/2" L/P	15	1.00" (25.4)	1.03" (26.2)	0.250" (6.4)	5,500 PSI 380 bar

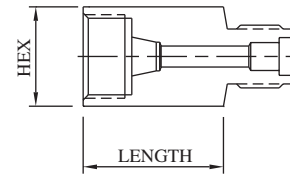

FEMALE M/P CONED AND THREADED TUBE

Connection	Suffix	Hex	Length	Port	MAWP*
1/4" M/P	16	0.75" (19.1)	1.03" (26.2)	0.109" (2.8)	20,000 PSI 1380 bar
3/8" M/P	17	0.75" (19.1)	1.03" (26.2)	0.203" (5.2)	20,000 PSI 1380 bar
9/16" M/P	18	1.00" (25.4)	1.29" (32.8)	0.250" (6.4)	20,000 PSI 1380 bar

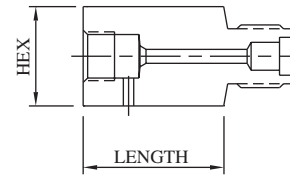

MALE M/P CONED AND THREADED TUBE

Connection	Suffix	Hex	Length	Port	MAWP*
1/4" M/P	8	0.75" (19.1)	1.91" (48.5)	0.109" (2.8)	20,000 PSI 1380 bar
3/8" M/P	10	0.75" (19.1)	1.91" (48.5)	0.203" (5.2)	20,000 PSI 1380 bar
9/16" M/P	11	0.75" (19.1)	2.12" (53.8)	0.312" (7.9)	20,000 PSI 1380 bar

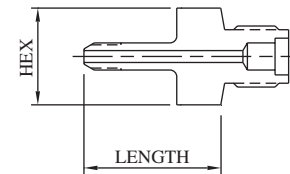

FEMALE H/P CONED AND THREADED TUBE

Connection	Suffix	Hex	Length	Port	MAWP*
1/4" H/P	23	0.75" (19.1)	1.03" (26.2)	0.093" (2.4)	20,000 PSI 1380 bar
3/8" H/P	24	1.00" (25.4)	1.03" (26.2)	0.125" (3.2)	20,000 PSI 1380 bar
9/16" H/P	25	1.38" (34.9)	1.16" (29.5)	0.187" (4.7)	20,000 PSI 1380 bar

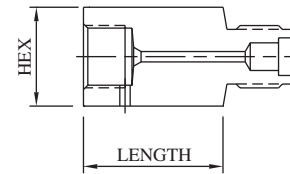

MALE H/P CONED AND THREADED TUBE

Connection	Suffix	Hex	Length	Port	MAWP*
1/4" H/P	9	0.75" (19.1)	1.91" (48.5)	0.093" (2.4)	20,000 PSI 1380 bar
3/8" H/P	30	0.75" (19.1)	2.12" (53.8)	0.125" (3.2)	20,000 PSI 1380 bar
9/16" H/P	42	0.75" (19.1)	2.86" (72.6)	0.187" (4.7)	20,000 PSI 1380 bar

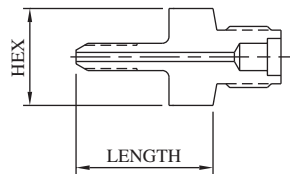

***CAUTION:** The maximum allowable working pressure (MAWP) of the valve shall not exceed the MAWP of the valve series or the selected connection, whichever is less.



All dimensions are for reference only and are subject to change.
Dimensions in parentheses are millimeters (mm).

10,000 PSI (690 BAR) 2-WAY BALL VALVES

Model No. K106

*MAWP: 10,000 PSI (690 bar)
 Port: 0.375" (9.5 mm)
 Cv: 3.40

Materials of Construction:

- 316 cold-worked stainless steel body and side adapters
- 17-4PH stem
- PEEK ball seals
- Glass-filled Teflon stem packings
- Viton O-rings

Ordering information and options on page BV-2

Repair Kit P/N RK-K106 contains ball, ball seals and seal retainers, o-rings, stem, stem packings, and washers

Mounting:

Panel: 1.06" (26.9 mm) dia
 0.43" (11.0 mm) max thickness
 Top: 1/4"-20 UNC
 Side: 0.28" (7.1 mm) dia

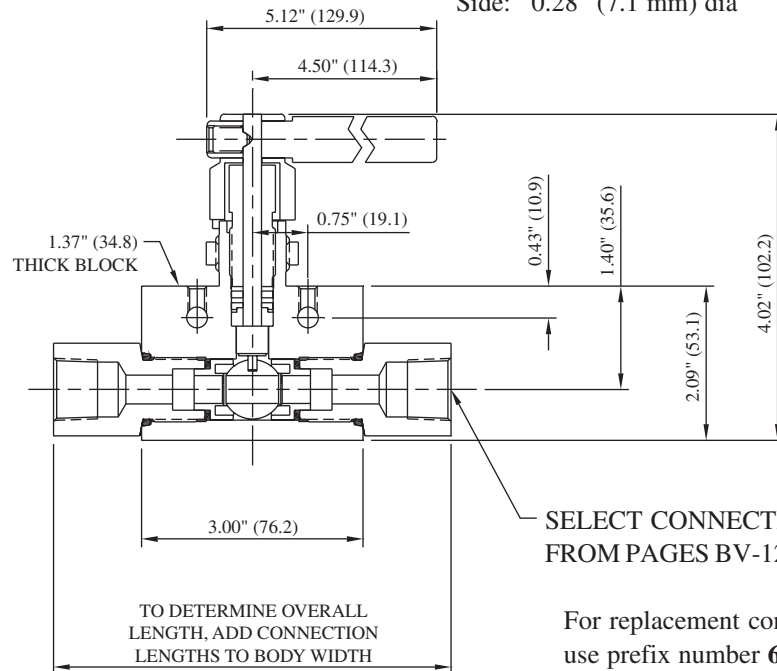

SELECT CONNECTIONS FROM PAGES BV-12 & BV-13

For replacement connections, use prefix number **6-** and suffix number. Ex: 6-20

FEMALE PIPE

Connection	Suffix	Hex	Length	Port	MAWP*
1/8" FNPT	19	1.00" (25.4)	0.69" (17.4)	0.339" (8.6)	15,000 PSI 1030 bar
1/4" FNPT	20	1.38" (34.9)	1.08" (27.4)	0.375" (9.5)	15,000 PSI 1030 bar
3/8" FNPT	21	1.38" (34.9)	1.02" (25.9)	0.375" (9.5)	15,000 PSI 1030 bar
1/2" FNPT	22	1.38" (34.9)	1.21" (30.7)	0.375" (9.5)	15,000 PSI 1030 bar
3/4" FNPT	41	1.38" (34.9)	1.33" (33.8)	0.375" (9.5)	10,000 PSI 690 bar
1" FNPT	45	1.75" (44.5)	1.62" (41.1)	0.375" (9.5)	10,000 PSI 690 bar

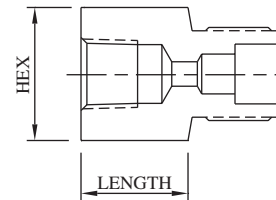

MALE PIPE

Connection	Suffix	Hex	Length	Port	MAWP*
1/8" MNPT	4	1.00" (25.4)	1.12" (28.4)	0.188" (4.8)	15,000 PSI 1030 bar
1/4" MNPT	5	1.38" (35.1)	1.41" (35.8)	0.258" (6.6)	15,000 PSI 1030 bar
3/8" MNPT	6	1.38" (34.9)	1.28" (32.5)	0.375" (9.5)	15,000 PSI 1030 bar
1/2" MNPT	7	1.38" (34.9)	1.33" (33.8)	0.375" (9.5)	15,000 PSI 1030 bar
3/4" MNPT	55	1.38" (35.1)	1.60" (40.6)	0.375" (9.5)	10,000 PSI 690 bar
1" MNPT	56	1.50" (38.1)	1.91" (48.5)	0.375" (9.5)	10,000 PSI 690 bar

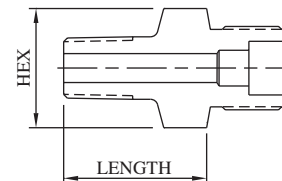

***CAUTION:** The maximum allowable working pressure (MAWP) of the valve shall not exceed the MAWP of the valve series or the selected connection, whichever is less.

All dimensions are for reference only and are subject to change.
 Dimensions in parentheses are millimeters (mm).



10,000 PSI (690 BAR) 2-WAY BALL VALVES

Model No. **K106**

FEMALE SINGLE-FERRULE TUBE

Connection	Suffix	Hex	Length	Port	MAWP*
1/4" SL/P	13	1.38" (34.9)	0.66" (16.8)	0.257" (6.5)	11,500 PSI 790 bar
3/8" SL/P	14	1.38" (34.9)	1.00" (25.4)	0.312" (7.9)	7,500 PSI 520 bar
1/2" L/P	15	1.38" (34.9)	1.08" (27.4)	0.375" (9.5)	5,500 PSI 380 bar

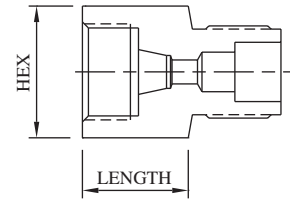

FEMALE M/P CONED AND THREADED TUBE

Connection	Suffix	Hex	Length	Port	MAWP
1/4" M/P	16	1.38" (35.1)	0.77" (19.6)	0.109" (2.8)	20,000 PSI 1380 bar
3/8" M/P	17	1.38" (35.1)	1.08" (27.4)	0.203" (5.2)	20,000 PSI 1380 bar
9/16" M/P	18	1.38" (35.1)	1.33" (33.8)	0.312" (7.9)	20,000 PSI 1380 bar
3/4" M/P	32	1.38" (35.1)	1.53" (38.9)	0.375" (9.5)	20,000 PSI 1380 bar
1" M/P	43	1.75" (44.5)	1.91" (48.5)	0.375" (9.5)	20,000 PSI 1380 bar

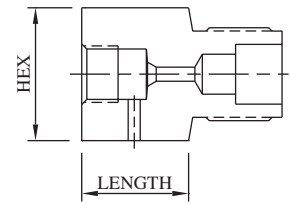

MALE M/P CONED AND THREADED TUBE

Connection	Suffix	Hex	Length	Port	MAWP*
1/4" M/P	8	1.00" (25.4)	1.89" (48.0)	0.109" (2.8)	20,000 PSI 1380 bar
3/8" M/P	10	1.38" (34.9)	1.90" (48.3)	0.203" (5.2)	20,000 PSI 1380 bar
9/16" M/P	11	1.38" (34.9)	2.13" (54.1)	0.312" (7.9)	20,000 PSI 1380 bar
3/4" M/P	37	1.38" (34.9)	5.08" (129.0)	0.437" (11.1)	20,000 PSI 1380 bar
1" M/P	49	1.38" (35.1)	3.21" (81.5)	0.437" (11.1)	20,000 PSI 1380 bar

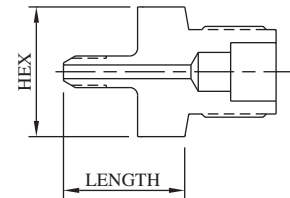

FEMALE H/P CONED AND THREADED TUBE

Connection	Suffix	Hex	Length	Port	MAWP*
1/4" H/P	23	1.38" (34.9)	1.02" (25.9)	0.083" (2.1)	20,000 PSI 1380 bar
3/8" H/P	24	1.38" (34.9)	1.04" (26.4)	0.125" (3.2)	20,000 PSI 1380 bar
9/16" H/P	25	1.38" (34.9)	1.13" (28.7)	0.187" (4.7)	20,000 PSI 1380 bar

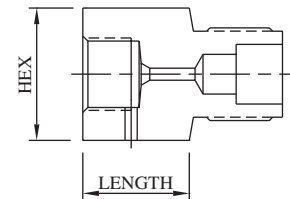

MALE H/P CONED AND THREADED TUBE

Connection	Suffix	Hex	Length	Port	MAWP*
1/4" H/P	9	1.00" (25.4)	1.98" (50.3)	0.083" (2.1)	20,000 PSI 1380 bar
3/8" H/P	30	1.00" (25.4)	2.38" (60.5)	0.125" (3.2)	20,000 PSI 1380 bar
9/16" H/P	42	1.00" (25.4)	2.85" (72.4)	0.188" (4.8)	20,000 PSI 1380 bar

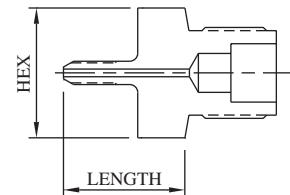

***CAUTION:** The maximum allowable working pressure (MAWP) of the valve shall not exceed the MAWP of the valve series or the selected connection, whichever is less.



All dimensions are for reference only and are subject to change.
Dimensions in parentheses are millimeters (mm).

10,000 PSI (690 BAR) 2-WAY BALL VALVES

Model No. K108

*MAWP: 10,000 PSI (690 bar)
 Port: 0.500" (12.7 mm)
 Cv: 10.00

Materials of Construction:

- 316 cold-worked stainless steel body and side adapters
- 17-4PH stem
- PEEK ball seals
- Glass-filled Teflon stem packings
- Viton O-rings

Ordering information and options on page BV-2

Repair Kit P/N RK-K108 contains ball, ball seals and seal retainers, o-rings, stem, stem packings, and washers

Mounting:

Side: 0.28" (7.1 mm) dia

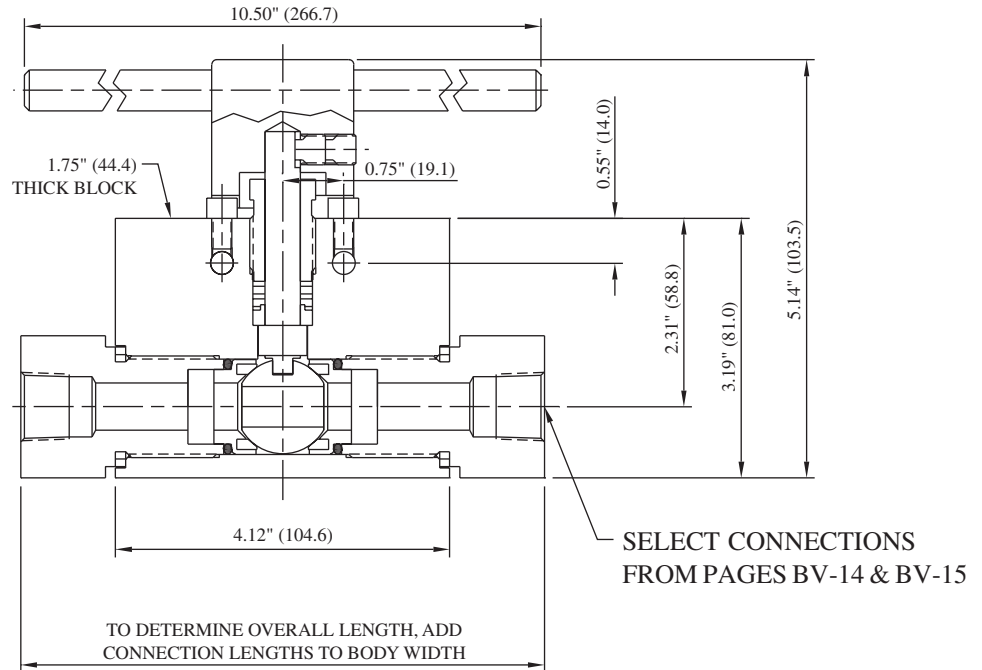

For replacement connections, use prefix number **8-** and suffix number. Ex: 8-22

FEMALE PIPE

Connection	Suffix	Hex	Length	Port	MAWP*
3/8" FNPT	21	1.75" (44.5)	1.00" (25.4)	0.578" (14.7)	15,000 PSI 1030 bar
1/2" FNPT	22	1.75" (44.5)	1.17" (29.7)	0.580" (14.7)	15,000 PSI 1030 bar
3/4" FNPT	41	1.75" (44.5)	1.33" (33.8)	0.580" (14.7)	10,000 PSI 690 bar
1" FNPT	45	1.75" (44.5)	1.54" (39.1)	0.580" (14.7)	10,000 PSI 690 bar
1-1/2" FNPT	46	2.50" (63.5)	1.92" (48.8)	0.580" (14.7)	5,000 PSI 340 bar

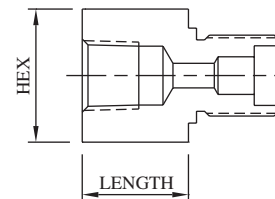

MALE PIPE

Connection	Suffix	Hex	Length	Port	MAWP*
3/8" MNPT	6	1.75" (44.5)	1.57" (39.9)	0.375" (9.5)	15,000 PSI 1030 bar
1/2" MNPT	7	1.75" (44.5)	1.80" (45.7)	0.500" (12.7)	15,000 PSI 1030 bar
3/4" MNPT	55	1.75" (44.5)	1.75" (44.5)	0.580" (14.7)	10,000 PSI 690 bar
1" MNPT	56	1.75" (44.5)	1.37" (34.8)	0.580" (14.7)	10,000 PSI 690 bar
1-1/2" MNPT	121	2.13" (54.0)	1.92" (48.8)	0.580" (14.7)	5,000 PSI 340 bar

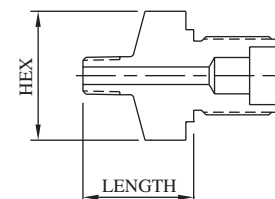

***CAUTION:** The maximum allowable working pressure (MAWP) of the valve shall not exceed the MAWP of the valve series or the selected connection, whichever is less.

All dimensions are for reference only and are subject to change.
 Dimensions in parentheses are millimeters (mm).



10,000 PSI (690 BAR) 2-WAY BALL VALVES

Model No. **K108**

FEMALE COMPRESSION TUBE CONNECTIONS

Connection	Suffix	Hex	Length	Port	MAWP*
3/8" SL/P	14	1.75" (44.5)	1.00" (25.4)	0.312" (7.9)	7,500 PSI 520 bar
1/2" L/P	15	1.75" (44.5)	1.00" (25.4)	0.438" (11.1)	5,500 PSI 380 bar

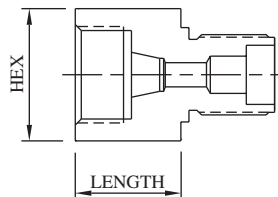

FEMALE M/P CONED AND THREADED TUBE

Connection	Suffix	Hex	Length	Port	MAWP*
3/8" M/P	17	1.75" (44.5)	0.87" (22.1)	0.203" (5.2)	20,000 PSI 1380 bar
9/16" M/P	18	1.75" (44.5)	1.67" (42.4)	0.312" (7.9)	20,000 PSI 1380 bar
3/4" M/P	32	1.75" (44.5)	1.18" (30.0)	0.580" (14.7)	20,000 PSI 1380 bar
1" M/P	43	1.75" (44.5)	1.67" (42.4)	0.580" (14.7)	20,000 PSI 1380 bar

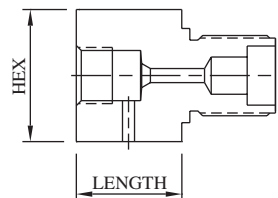

MALE M/P CONED AND THREADED TUBE

Connection	Suffix	Hex	Length	Port	MAWP*
3/8" M/P	10	1.75" (44.5)	2.33" (59.2)	0.203" (5.2)	20,000 PSI 1380 bar
9/16" M/P	11	1.75" (44.5)	2.71" (68.8)	0.312" (7.9)	20,000 PSI 1380 bar
3/4" M/P	37	1.75" (44.5)	2.74" (69.6)	0.438" (11.1)	20,000 PSI 1380 bar
1" M/P	49	1.75" (44.5)	2.88" (73.2)	0.562" (14.3)	20,000 PSI 1380 bar

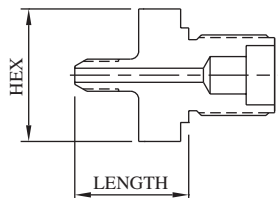

FEMALE H/P CONED AND THREADED TUBE

Connection	Suffix	Hex	Length	Port	MAWP*
1/4" H/P	23	1.75" (44.5)	0.63" (16.0)	0.093" (2.4)	20,000 PSI 1380 bar
3/8" H/P	24	1.75" (44.5)	1.00" (25.4)	0.125" (3.2)	20,000 PSI 1380 bar
9/16" H/P	25	1.75" (44.5)	1.06" (26.9)	0.188" (4.8)	20,000 PSI 1380 bar

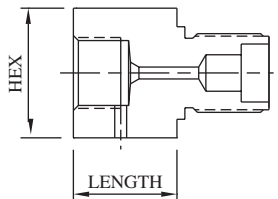

MALE H/P CONED AND THREADED TUBE

Connection	Suffix	Hex	Length	Port	MAWP*
1/4" H/P	9	1.75" (44.5)	2.22" (56.4)	0.083" (2.1)	20,000 PSI 1380 bar
3/8" H/P	30	1.75" (44.5)	2.45" (62.2)	0.125" (3.2)	20,000 PSI 1380 bar
9/16" H/P	42	1.75" (44.5)	2.96" (75.2)	0.188" (4.8)	20,000 PSI 1380 bar

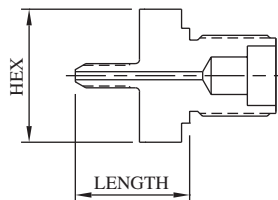

***CAUTION:** The maximum allowable working pressure (MAWP) of the valve shall not exceed the MAWP of the valve series or the selected connection, whichever is less.

All dimensions are for reference only and are subject to change.
Dimensions in parentheses are millimeters (mm).



20,000 PSI (1380 BAR) 2-WAY BALL VALVES

Model No. K204

*MAWP: 20,000 PSI (1380 bar)
 Port: 0.250" (6.4 mm)
 Cv: 1.40

Materials of Construction:

- 316 cold-worked stainless steel body and side adapters
- 17-4PH stem
- PEEK ball seals
- Glass-filled Teflon stem packings
- Viton O-rings

Ordering information and options on page BV-2

Repair Kit P/N RK-K204 contains ball, ball seals and seal retainers, o-rings, stem, stem packings, and washers

Mounting:

Panel: 1.06" (26.9 mm) dia
 0.43" (11.0 mm) max thickness
 Top: 1/4"-20 UNC
 Side: 0.28" (7.1 mm) dia

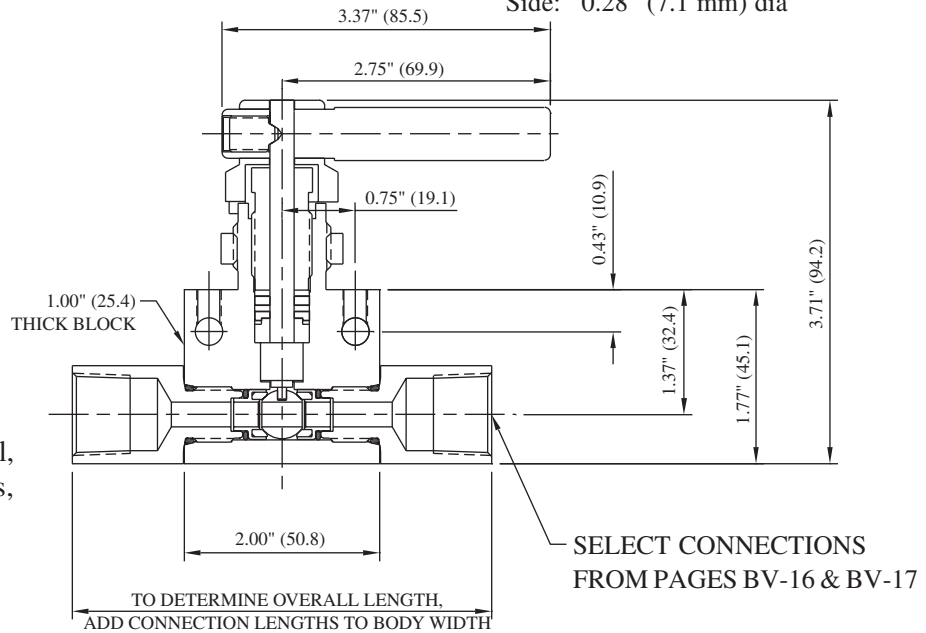

For replacement connections, use prefix number **4-** and suffix number. Ex: 4-20

FEMALE PIPE

Connection	Suffix	Hex	Length	Port	MAWP*
1/8" FNPT	19	0.75" (19.1)	1.03" (26.2)	0.250" (6.4)	15,000 PSI 1030 bar
1/4" FNPT	20	0.75" (19.1)	1.03" (26.2)	0.250" (6.4)	15,000 PSI 1030 bar
3/8" FNPT	21	1.38" (35.1)	1.03" (26.2)	0.250" (6.4)	15,000 PSI 1030 bar
1/2" FNPT	22	1.38" (35.1)	1.16" (29.5)	0.250" (6.4)	15,000 PSI 1030 bar

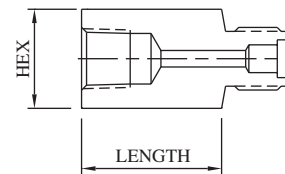

MALE PIPE

Connection	Suffix	Hex	Length	Port	MAWP*
1/8" MNPT	4	0.75" (19.1)	1.03" (26.2)	0.125" (3.2)	15,000 PSI 1030 bar
1/4" MNPT	5	0.75" (19.1)	1.03" (26.2)	0.250" (6.4)	15,000 PSI 1030 bar
3/8" MNPT	6	0.75" (19.1)	1.03" (26.2)	0.250" (6.4)	15,000 PSI 1030 bar
1/2" MNPT	7	1.00" (25.4)	1.29" (32.8)	0.250" (6.4)	15,000 PSI 1030 bar

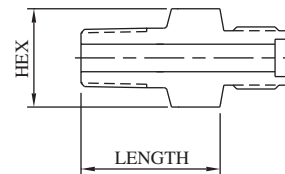

***CAUTION:** The maximum allowable working pressure (MAWP) of the valve shall not exceed the MAWP of the valve series or the selected connection, whichever is less.

All dimensions are for reference only and are subject to change.
 Dimensions in parentheses are millimeters (mm).



20,000 PSI (1380 BAR) 2-WAY BALL VALVES

Model No. **K204**

FEMALE SINGLE-FERRULE TUBE

Connection	Suffix	Hex	Length	Port	MAWP*
1/8" L/P	12	0.75" (19.1)	0.78" (19.8)	0.093" (2.4)	15,000 PSI 1030 bar
1/4" SL/P	13	0.75" (19.1)	1.03" (26.2)	0.125" (3.2)	11,500 PSI 790 bar
3/8" SL/P	14	0.75" (19.1)	1.03" (26.2)	0.250" (6.4)	7,500 PSI 520 bar
1/2" L/P	15	1.00" (25.4)	1.03" (26.2)	0.250" (6.4)	5,500 PSI 380 bar

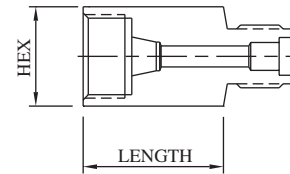

FEMALE M/P CONED AND THREADED TUBE

Connection	Suffix	Hex	Length	Port	MAWP*
1/4" M/P	16	0.75" (19.1)	1.03" (26.2)	0.109" (2.8)	20,000 PSI 1380 bar
3/8" M/P	17	0.75" (19.1)	1.03" (26.2)	0.203" (5.2)	20,000 PSI 1380 bar
9/16" M/P	18	1.00" (25.4)	1.29" (32.8)	0.250" (6.4)	20,000 PSI 1380 bar

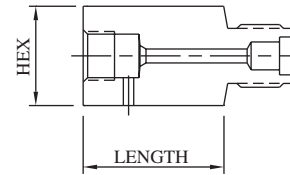

MALE M/P CONED AND THREADED TUBE

Connection	Suffix	Hex	Length	Port	MAWP*
1/4" M/P	8	0.75" (19.1)	1.91" (48.5)	0.109" (2.8)	20,000 PSI 1380 bar
3/8" M/P	10	0.75" (19.1)	1.91" (48.5)	0.203" (5.2)	20,000 PSI 1380 bar
9/16" M/P	11	0.75" (19.1)	2.12" (53.8)	0.312" (7.9)	20,000 PSI 1380 bar

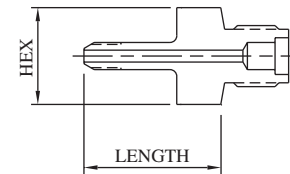

FEMALE H/P CONED AND THREADED TUBE

Connection	Suffix	Hex	Length	Port	MAWP*
1/4" H/P	23	0.75" (19.1)	1.03" (26.2)	0.093" (2.4)	20,000 PSI 1380 bar
3/8" H/P	24	1.00" (25.4)	1.03" (26.2)	0.125" (3.2)	20,000 PSI 1380 bar
9/16" H/P	25	1.38" (34.9)	1.16" (29.5)	0.187" (4.7)	20,000 PSI 1380 bar

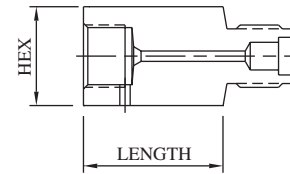

MALE H/P CONED AND THREADED TUBE

Connection	Suffix	Hex	Length	Port	MAWP*
1/4" H/P	9	0.75" (19.1)	1.91" (48.5)	0.093" (2.4)	20,000 PSI 1380 bar
3/8" H/P	30	0.75" (19.1)	2.12" (53.8)	0.125" (3.2)	20,000 PSI 1380 bar
9/16" H/P	42	0.75" (19.1)	2.86" (72.6)	0.187" (4.7)	20,000 PSI 1380 bar

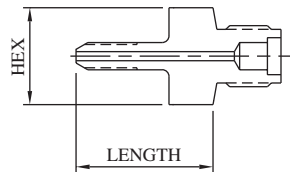

***CAUTION:** The maximum allowable working pressure (MAWP) of the valve shall not exceed the MAWP of the valve series or the selected connection, whichever is less.



All dimensions are for reference only and are subject to change.
Dimensions in parentheses are millimeters (mm).

20,000 PSI (1380 BAR) 2-WAY BALL VALVES

Model No. K206

*MAWP: 20,000 PSI (1380 bar)
 Port: 0.375" (9.5 mm)
 Cv: 3.40

Materials of Construction:

- 316 cold-worked stainless steel body and side adapters
- 17-4PH stem
- PEEK ball seals
- Glass-filled Teflon stem packings
- Viton O-rings

Ordering information and options on page BV-2

Repair Kit P/N RK-K206 contains ball, ball seals and seal retainers, o-rings, stem, stem packings, and washers

Mounting:

Panel: 1.06" (26.9 mm) dia
 0.43" (11.0 mm) max thickness
 Top: 1/4"-20 UNC
 Side: 0.28" (7.1 mm) dia

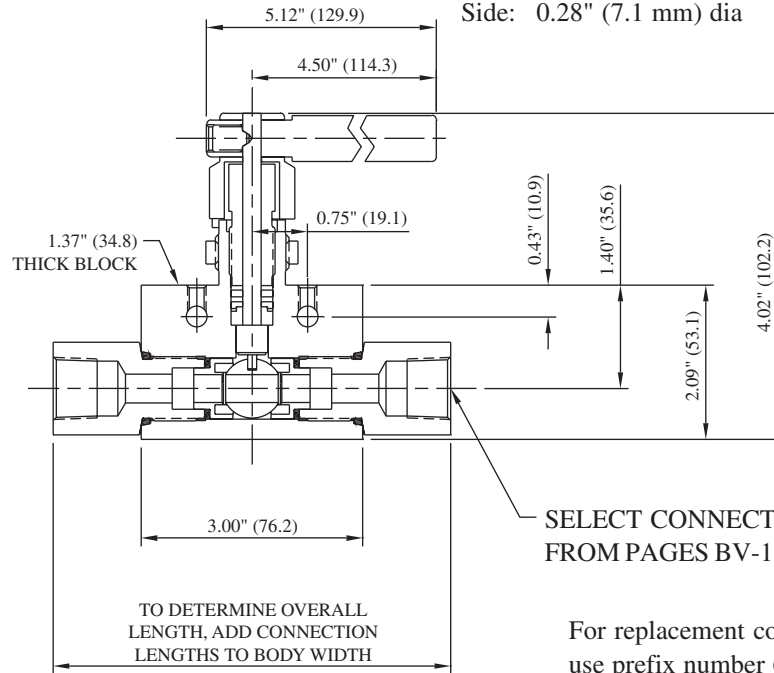

SELECT CONNECTIONS FROM PAGES BV-18 & BV-19

For replacement connections, use prefix number **6-** and suffix number. Ex: 6-20

FEMALE PIPE

Connection	Suffix	Hex	Length	Port	MAWP*
1/8" FNPT	19	1.00" (25.4)	0.69" (17.4)	0.339" (8.6)	15,000 PSI 1030 bar
1/4" FNPT	20	1.38" (34.9)	1.08" (27.4)	0.375" (9.5)	15,000 PSI 1030 bar
3/8" FNPT	21	1.38" (34.9)	1.02" (25.9)	0.375" (9.5)	15,000 PSI 1030 bar
1/2" FNPT	22	1.38" (34.9)	1.21" (30.7)	0.375" (9.5)	15,000 PSI 1030 bar
3/4" FNPT	41	1.38" (34.9)	1.33" (33.8)	0.375" (9.5)	10,000 PSI 690 bar
1" FNPT	45	1.75" (44.5)	1.62" (41.1)	0.375" (9.5)	10,000 PSI 690 bar

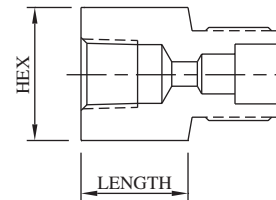

MALE PIPE

Connection	Suffix	Hex	Length	Port	MAWP*
1/8" MNPT	4	1.00" (25.4)	1.12" (28.4)	0.188" (4.8)	15,000 PSI 1030 bar
1/4" MNPT	5	1.38" (35.1)	1.41" (35.8)	0.258" (6.6)	15,000 PSI 1030 bar
3/8" MNPT	6	1.38" (34.9)	1.28" (32.5)	0.375" (9.5)	15,000 PSI 1030 bar
1/2" MNPT	7	1.38" (34.9)	1.33" (33.8)	0.375" (9.5)	15,000 PSI 1030 bar
3/4" MNPT	55	1.38" (35.1)	1.60" (40.6)	0.375" (9.5)	10,000 PSI 690 bar
1" MNPT	56	1.50" (38.1)	1.91" (48.5)	0.375" (9.5)	10,000 PSI 690 bar

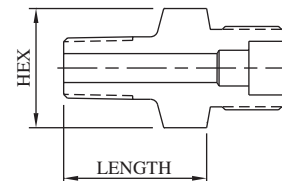

***CAUTION:** The maximum allowable working pressure (MAWP) of the valve shall not exceed the MAWP of the valve series or the selected connection, whichever is less.

All dimensions are for reference only and are subject to change.
 Dimensions in parentheses are millimeters (mm).



20,000 PSI (1380 BAR) 2-WAY BALL VALVES

Model No. **K206**

FEMALE SINGLE-FERRULE TUBE

Connection	Suffix	Hex	Length	Port	MAWP*
1/4" SL/P	13	1.38" (34.9)	0.66" (16.8)	0.257" (6.5)	11,500 PSI 790 bar
3/8" SL/P	14	1.38" (34.9)	1.00" (25.4)	0.312" (7.9)	7,500 PSI 520 bar
1/2" L/P	15	1.38" (34.9)	1.08" (27.4)	0.375" (9.5)	5,500 PSI 380 bar

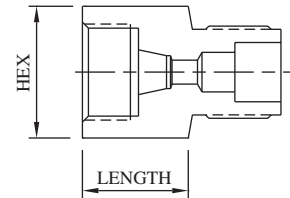

FEMALE M/P CONED AND THREADED TUBE

Connection	Suffix	Hex	Length	Port	MAWP
1/4" M/P	16	1.38" (35.1)	0.77" (19.6)	0.109" (2.8)	20,000 PSI 1380 bar
3/8" M/P	17	1.38" (35.1)	1.08" (27.4)	0.203" (5.2)	20,000 PSI 1380 bar
9/16" M/P	18	1.38" (35.1)	1.33" (33.8)	0.312" (7.9)	20,000 PSI 1380 bar
3/4" M/P	32	1.38" (35.1)	1.53" (38.9)	0.375" (9.5)	20,000 PSI 1380 bar
1" M/P	43	1.75" (44.5)	1.91" (48.5)	0.375" (9.5)	20,000 PSI 1380 bar

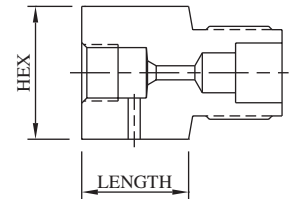

MALE M/P CONED AND THREADED TUBE

Connection	Suffix	Hex	Length	Port	MAWP*
1/4" M/P	8	1.00" (25.4)	1.89" (48.0)	0.109" (2.8)	20,000 PSI 1380 bar
3/8" M/P	10	1.38" (34.9)	1.90" (48.3)	0.203" (5.2)	20,000 PSI 1380 bar
9/16" M/P	11	1.38" (34.9)	2.13" (54.1)	0.312" (7.9)	20,000 PSI 1380 bar
3/4" M/P	37	1.38" (34.9)	5.08" (129.0)	0.437" (11.1)	20,000 PSI 1380 bar
1" M/P	49	1.38" (35.1)	3.21" (81.5)	0.437" (11.1)	20,000 PSI 1380 bar

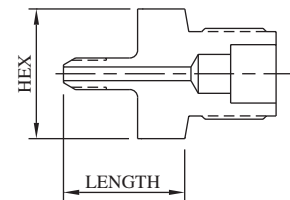

FEMALE H/P CONED AND THREADED TUBE

Connection	Suffix	Hex	Length	Port	MAWP*
1/4" H/P	23	1.38" (34.9)	1.02" (25.9)	0.083" (2.1)	20,000 PSI 1380 bar
3/8" H/P	24	1.38" (34.9)	1.04" (26.4)	0.125" (3.2)	20,000 PSI 1380 bar
9/16" H/P	25	1.38" (34.9)	1.13" (28.7)	0.187" (4.7)	20,000 PSI 1380 bar

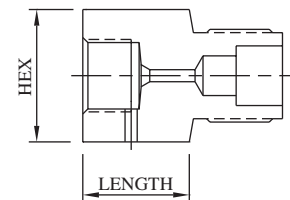

MALE H/P CONED AND THREADED TUBE

Connection	Suffix	Hex	Length	Port	MAWP*
1/4" H/P	9	1.00" (25.4)	1.98" (50.3)	0.083" (2.1)	20,000 PSI 1380 bar
3/8" H/P	30	1.00" (25.4)	2.38" (60.5)	0.125" (3.2)	20,000 PSI 1380 bar
9/16" H/P	42	1.00" (25.4)	2.85" (72.4)	0.188" (4.8)	20,000 PSI 1380 bar

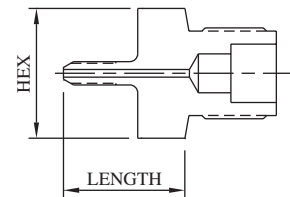

***CAUTION:** The maximum allowable working pressure (MAWP) of the valve shall not exceed the MAWP of the valve series or the selected connection, whichever is less.



All dimensions are for reference only and are subject to change.
Dimensions in parentheses are millimeters (mm).

TRUNNION VALVE FLOW CONFIGURATIONS

3-way Diverting P/N 3DVK*

3-way diverting ball valves are designed to divert media from a single source to one of two separate lines. The 90° quarter-turn design allows for continuous on-line service.

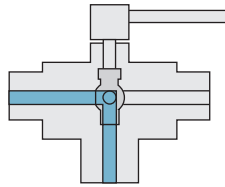

Open

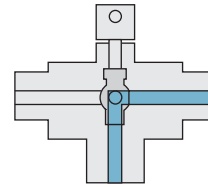

Open

3-way Switching P/N 3K*

3-way switching ball valves are designed to direct media from bottom inlet port to one of two separate lines. The 180° quarter-turn design allows for positive shutoff in the center position.

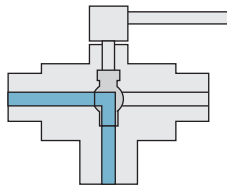

Open

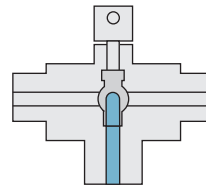

Closed

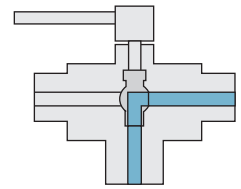

Open

4-way P/N 4K*

4-way ball valves utilize a double-ported ball for crossover of two flows. The 90° quarter-turn design allows for continuous on-line service. The valve can be used in place of a three valve manifold

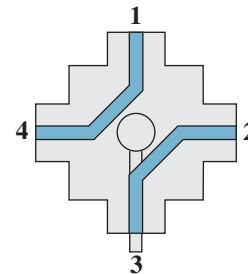
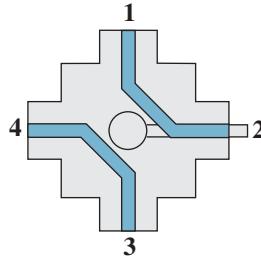

5-way P/N 5K*

5-way ball valves direct media flow from a single bottom inlet to one of four separate lines. The 360° quarter-turn design allows for continuous on-line service.

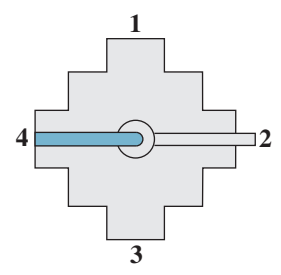
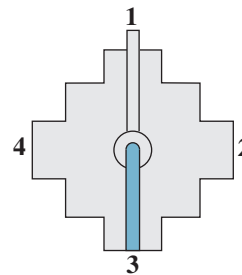
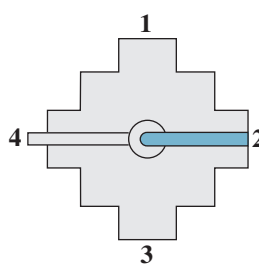
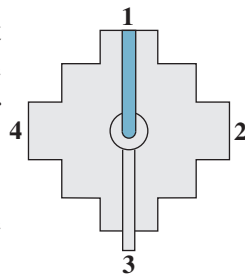

All BuTech Ball Valves are capable of bi-directional flow.

All dimensions are for reference only and are subject to change.
Dimensions in parentheses are millimeters (mm).

3000 PSI (210 BAR) 3-WAY TRUNNION VALVES

Mounting:

Panel: 0.78" (19.8 mm) dia
0.37" (9.4 mm) max thickness

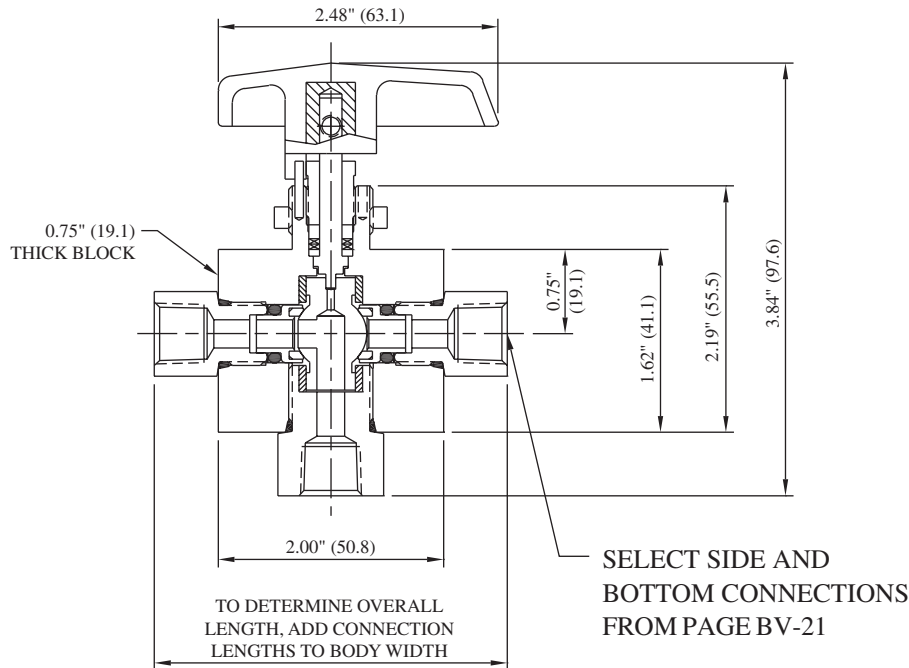

Model No. 3K34
3DVK34

*MAWP: 3,000 PSI (210 bar)
Port: 0.250" (6.4 mm)
Cv: 1.00

Materials of Construction:

- 316 cold-worked stainless steel body and side adapters
- 316 cold-worked stem
- PEEK ball seals
- Glass-filled Teflon stem packings
- Viton O-rings

Ordering information and options on page BV-2

Repair Kit P/N's **RK-3K34** and **RK-3DVK34** contain trunnion, trunnion seals and seal retainers, o-rings, pins, stem, stem packings, and washers

For replacement connections, use prefix number **40-** and suffix number. Ex: 40-20

FEMALE PIPE

Connection	For Side Connections				For Bottom Connection				MAWP*
	Suffix	Hex	Length	Port	Suffix	Hex	Length	Port	
1/8" FNPT	19	0.75" (19.1)	0.58" (14.7)	0.250" (6.4)	19B	0.75" (19.1)	0.43" (10.9)	0.250" (6.4)	15,000 PSI 1030 bar
1/4" FNPT	20	0.75" (19.1)	0.58" (14.7)	0.250" (6.4)	20B	0.75" (19.1)	0.73" (18.5)	0.250" (6.4)	15,000 PSI 1030 bar
3/8" FNPT	21	1.00" (25.4)	0.75" (19.1)	0.250" (6.4)	21B	1.00" (25.4)	0.81" (20.6)	0.250" (6.4)	15,000 PSI 1030 bar
1/2" FNPT	22	1.18" (30.0)	1.00" (25.4)	0.250" (6.4)	22B	1.18" (30.0)	0.96" (24.4)	0.250" (6.4)	15,000 PSI 1030 bar

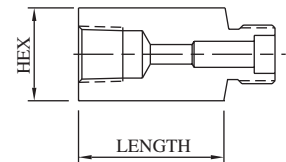

MALE PIPE

Connection	For Side Connections				For Bottom Connection				MAWP*
	Suffix	Hex	Length	Port	Suffix	Hex	Length	Port	
1/8" MNPT	4	0.75" (19.1)	0.97" (24.6)	0.250" (6.4)	4B	0.75" (19.1)	0.97" (24.6)	0.250" (6.4)	15,000 PSI 1030 bar
1/4" MNPT	5	0.75" (19.1)	1.19" (30.2)	0.250" (6.4)	5B	0.75" (19.1)	1.19" (30.2)	0.250" (6.4)	15,000 PSI 1030 bar
3/8" MNPT	6	1.00" (25.4)	1.30" (33.0)	0.250" (6.4)	6B	1.00" (25.4)	1.30" (33.0)	0.250" (6.4)	15,000 PSI 1030 bar
1/2" MNPT	7	1.00" (25.4)	1.55" (39.4)	0.250" (6.4)	7B	1.00" (25.4)	1.55" (39.4)	0.250" (6.4)	15,000 PSI 1030 bar

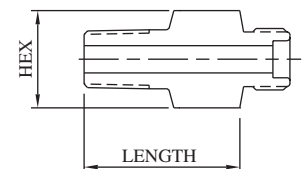

***CAUTION:** The maximum allowable working pressure (MAWP) of the valve shall not exceed the MAWP of the valve series or the selected connection, whichever is less.



All dimensions are for reference only and are subject to change.
Dimensions in parentheses are millimeters (mm).

6000 PSI (410 BAR) 3-WAY TRUNNION VALVES

**Model No. 3K63
3DVK63**

Mounting:

Panel: 0.91" (23.0 mm) dia
0.31" (7.8 mm) max thickness

*MAWP: 6,000 PSI (410 bar)
Port: 0.187" (4.7 mm)
Cv: 0.56

Materials of Construction:

- 316 cold-worked stainless steel body and side adapters
- 316 cold-worked stem
- PEEK ball seals
- Glass-filled Teflon stem packings
- Viton O-rings

Ordering information and options on page BV-2

Repair Kit P/N's RK-3K63 and RK-3DVK63 contain trunnion, trunnion seals and seal retainers, o-rings, spring washers, stem, stem packings, and washers

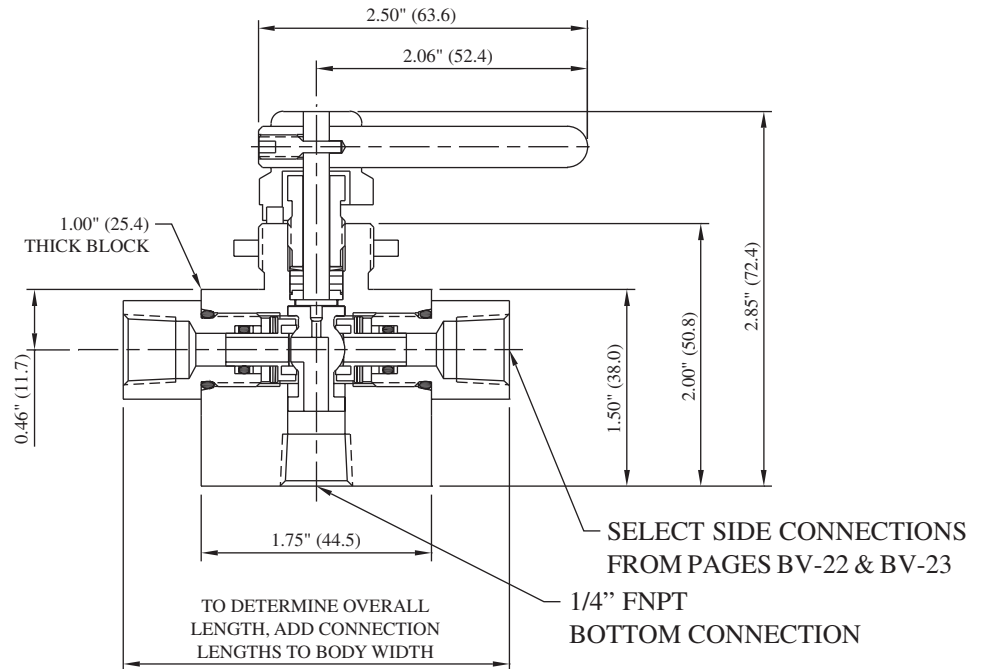

For replacement connections, use prefix number **3-** and suffix number. Ex: 3-20

FEMALE PIPE

Connection	For Side Connections				For Bottom Connection				MAWP*
	Suffix	Hex	Length	Port	Suffix	Hex	Length	Port	
1/8" FNPT	19	0.75" (19.1)	0.60" (15.2)	0.250" (6.4)	19B	1.00" (25.4)	0.63" (16.0)	0.250" (6.4)	15,000 PSI 1030 bar
1/4" FNPT	20	0.75" (19.1)	0.60" (15.2)	0.250" (6.4)	20B	1.00" (25.4)	0.55" (14.0)	0.250" (6.4)	15,000 PSI 1030 bar
3/8" FNPT	21	1.00" (25.4)	1.01" (25.7)	0.250" (6.4)	21B	1.00" (25.4)	1.01" (25.7)	0.250" (6.4)	15,000 PSI 1030 bar
1/2" FNPT	22	1.00" (25.4)	1.01" (25.7)	0.250" (6.4)	22B	1.00" (25.4)	1.16" (29.5)	0.250" (6.4)	15,000 PSI 1030 bar

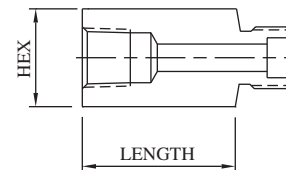

MALE PIPE

Connection	For Side Connections				For Bottom Connection				MAWP*
	Suffix	Hex	Length	Port	Suffix	Hex	Length	Port	
1/8" MNPT	4	0.75" (19.1)	1.01" (25.7)	0.125" (3.2)	4B	1.00" (25.4)	0.93" (23.6)	0.125" (3.2)	15,000 PSI 1030 bar
1/4" MNPT	5	0.75" (19.1)	1.01" (25.7)	0.250" (6.4)	5B	1.00" (25.4)	1.05" (26.7)	0.250" (6.4)	15,000 PSI 1030 bar
3/8" MNPT	6	0.75" (19.1)	1.01" (25.7)	0.250" (6.4)	6B	1.00" (25.4)	1.01" (25.7)	0.250" (6.4)	15,000 PSI 1030 bar
1/2" MNPT	7	1.00" (25.4)	1.26" (32.0)	0.250" (6.4)	7B	1.00" (25.4)	1.29" (32.8)	0.250" (6.4)	15,000 PSI 1030 bar

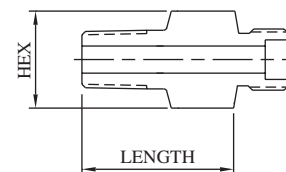

***CAUTION:** The maximum allowable working pressure (MAWP) of the valve shall not exceed the MAWP of the valve series or the selected connection, whichever is less.



All dimensions are for reference only and are subject to change.
Dimensions in parentheses are millimeters (mm).



6000 PSI (410 BAR) 3-WAY TRUNNION VALVES

Model No. **3K63**
3DVK63

FEMALE SINGLE-FERRULE TUBE

For Side Connections					
Connection	Suffix	Hex	Length	Port	MAWP*
1/8" L/P	12	0.75" (19.1)	0.78" (19.8)	0.093" (2.4)	15,000 PSI 1030 bar
1/4" SL/P	13	0.75" (19.1)	1.03" (26.2)	0.125" (3.2)	11,500 PSI 790 bar
3/8" SL/P	14	0.75" (19.1)	1.03" (26.2)	0.250" (6.4)	7,500 PSI 520 bar
1/2" L/P	15	1.00" (25.4)	1.03" (26.2)	0.250" (6.4)	5,500 PSI 380 bar

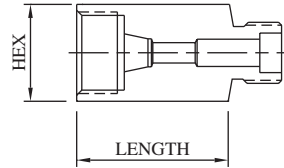

FEMALE M/P CONED AND THREADED TUBE

For Side Connections					
Connection	Suffix	Hex	Length	Port	MAWP*
1/4" M/P	16	0.75" (19.1)	0.74" (18.8)	0.109" (2.8)	20,000 PSI 1380 bar
3/8" M/P	17	0.75" (19.1)	1.01" (25.7)	0.203" (5.2)	20,000 PSI 1380 bar
9/16" M/P	18	1.00" (25.4)	1.26" (32.0)	0.250" (6.4)	20,000 PSI 1380 bar

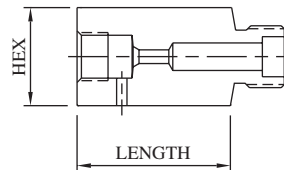

MALE M/P CONED AND THREADED TUBE

For Side Connections					
Connection	Suffix	Hex	Length	Port	MAWP*
1/4" M/P	8	0.75" (19.1)	1.88" (47.8)	0.109" (2.8)	20,000 PSI 1380 bar
3/8" M/P	10	0.75" (19.1)	2.00" (50.8)	0.203" (5.2)	20,000 PSI 1380 bar
9/16" M/P	11	1.00" (25.4)	2.31" (58.7)	0.250" (6.4)	20,000 PSI 1380 bar

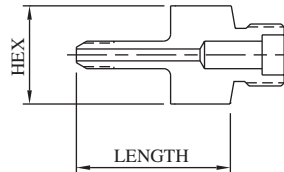

FEMALE H/P CONED AND THREADED TUBE

For Side Connections					
Connection	Suffix	Hex	Length	Port	MAWP*
1/4" H/P	23	0.75" (19.1)	1.01" (25.7)	0.093" (2.4)	20,000 PSI 1380 bar
3/8" H/P	24	1.00" (25.4)	1.17" (29.7)	0.125" (3.2)	20,000 PSI 1380 bar
9/16" H/P	25	1.37" (34.8)	1.25" (31.8)	0.187" (4.7)	20,000 PSI 1380 bar

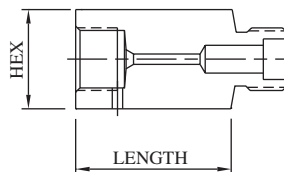

MALE H/P CONED AND THREADED TUBE

For Side Connections					
Connection	Suffix	Hex	Length	Port	MAWP*
1/4" H/P	9	0.75" (19.1)	1.94" (49.3)	0.083" (2.1)	20,000 PSI 1380 bar
3/8" H/P	30	0.75" (19.1)	2.25" (57.2)	0.125" (3.2)	20,000 PSI 1380 bar
9/16" H/P	42	0.75" (19.1)	2.82" (71.6)	0.187" (4.7)	20,000 PSI 1380 bar

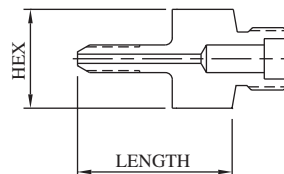

***CAUTION:** The maximum allowable working pressure (MAWP) of the valve shall not exceed the MAWP of the valve series or the selected connection, whichever is less.



All dimensions are for reference only and are subject to change.
Dimensions in parentheses are millimeters (mm).



10,000 PSI (690 BAR) 3-WAY TRUNNION VALVES

**Model No. 3K93
3DVK93**

Mounting:

Panel: 0.91" (23.0 mm) dia
0.31" (7.8 mm) max thickness

*MAWP: 10,000 PSI (690 bar)
Port: 0.187" (4.7 mm)
Cv: 0.56

Materials of Construction:

- 316 cold-worked stainless steel body and side adapters
- 316 cold-worked stem
- PEEK ball seals
- Glass-filled Teflon stem packings
- Viton O-rings

Ordering information and options on page BV-2

Repair Kit P/N's RK-3K93 and RK-3DVK93 contain trunnion, trunnion seals and seal retainers, o-rings, stem, stem packings, and spring washers

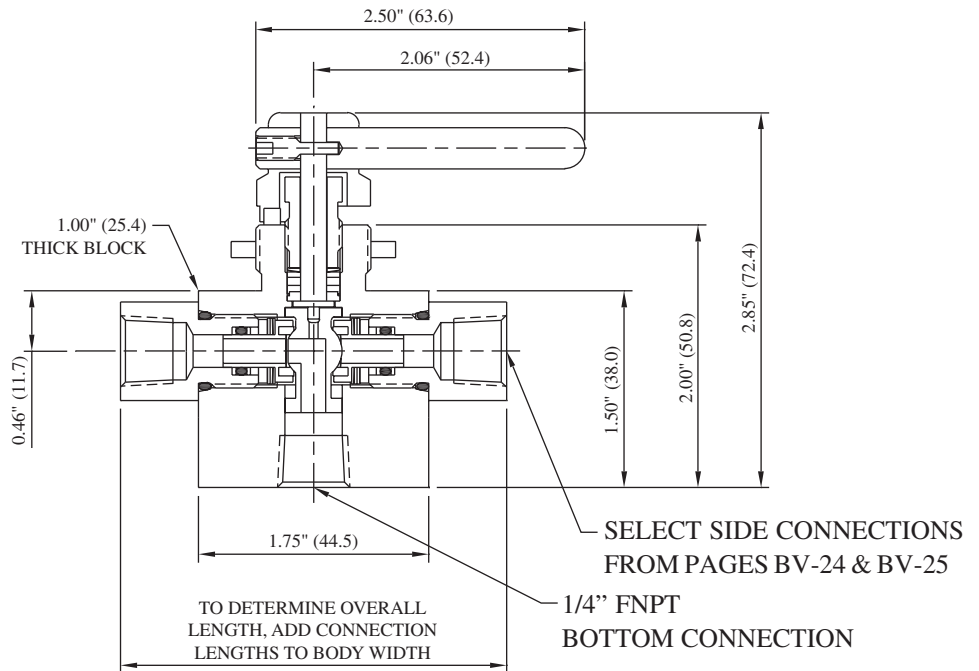

For replacement connections, use prefix number **3-** and suffix number. Ex: 3-20

FEMALE PIPE

Connection	For Side Connections				For Bottom Connection				MAWP*
	Suffix	Hex	Length	Port	Suffix	Hex	Length	Port	
1/8" FNPT	19	0.75" (19.1)	0.60" (15.2)	0.250" (6.4)	19B	1.00" (25.4)	0.63" (16.0)	0.250" (6.4)	15,000 PSI 1030 bar
1/4" FNPT	20	0.75" (19.1)	0.60" (15.2)	0.250" (6.4)	20B	1.00" (25.4)	0.55" (14.0)	0.250" (6.4)	15,000 PSI 1030 bar
3/8" FNPT	21	1.00" (25.4)	1.01" (25.7)	0.250" (6.4)	21B	1.00" (25.4)	1.01" (25.7)	0.250" (6.4)	15,000 PSI 1030 bar
1/2" FNPT	22	1.00" (25.4)	1.01" (25.7)	0.250" (6.4)	22B	1.00" (25.4)	1.16" (29.5)	0.250" (6.4)	15,000 PSI 1030 bar

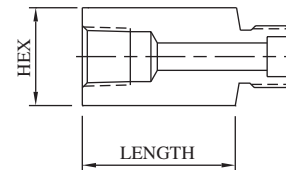

MALE PIPE

Connection	For Side Connections				For Bottom Connection				MAWP*
	Suffix	Hex	Length	Port	Suffix	Hex	Length	Port	
1/8" MNPT	4	0.75" (19.1)	1.01" (25.7)	0.125" (3.2)	4B	1.00" (25.4)	0.93" (23.6)	0.125" (3.2)	15,000 PSI 1030 bar
1/4" MNPT	5	0.75" (19.1)	1.01" (25.7)	0.250" (6.4)	5B	1.00" (25.4)	1.05" (26.7)	0.250" (6.4)	15,000 PSI 1030 bar
3/8" MNPT	6	0.75" (19.1)	1.01" (25.7)	0.250" (6.4)	6B	1.00" (25.4)	1.01" (25.7)	0.250" (6.4)	15,000 PSI 1030 bar
1/2" MNPT	7	1.00" (25.4)	1.26" (32.0)	0.250" (6.4)	7B	1.00" (25.4)	1.29" (32.8)	0.250" (6.4)	15,000 PSI 1030 bar

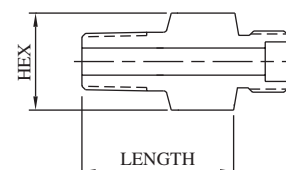

***CAUTION:** The maximum allowable working pressure (MAWP) of the valve shall not exceed the MAWP of the valve series or the selected connection, whichever is less.

All dimensions are for reference only and are subject to change.
Dimensions in parentheses are millimeters (mm).



10,000 PSI (690 BAR) 3-WAY TRUNNION VALVES

Model No. **3K93**
3DVK93

FEMALE SINGLE-FERRULE TUBE

For Side Connections					
Connection	Suffix	Hex	Length	Port	MAWP*
1/8" L/P	12	0.75" (19.1)	0.78" (19.8)	0.093" (2.4)	15,000 PSI 1030 bar
1/4" SL/P	13	0.75" (19.1)	1.03" (26.2)	0.125" (3.2)	11,500 PSI 790 bar
3/8" SL/P	14	0.75" (19.1)	1.03" (26.2)	0.250" (6.4)	7,500 PSI 520 bar
1/2" L/P	15	1.00" (25.4)	1.03" (26.2)	0.250" (6.4)	5,500 PSI 380 bar

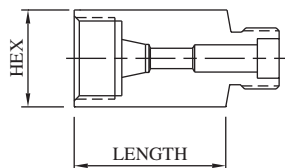

FEMALE M/P CONED AND THREADED TUBE

For Side Connections					
Connection	Suffix	Hex	Length	Port	MAWP*
1/4" M/P	16	0.75" (19.1)	0.74" (18.8)	0.109" (2.8)	20,000 PSI 1380 bar
3/8" M/P	17	0.75" (19.1)	1.01" (25.7)	0.203" (5.2)	20,000 PSI 1380 bar
9/16" M/P	18	1.00" (25.4)	1.26" (32.0)	0.250" (6.4)	20,000 PSI 1380 bar

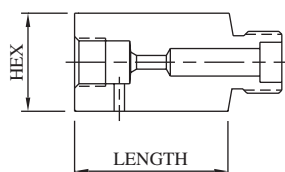

MALE M/P CONED AND THREADED TUBE

For Side Connections					
Connection	Suffix	Hex	Length	Port	MAWP*
1/4" M/P	8	0.75" (19.1)	1.88" (47.8)	0.109" (2.8)	20,000 PSI 1380 bar
3/8" M/P	10	0.75" (19.1)	2.00" (50.8)	0.203" (5.2)	20,000 PSI 1380 bar
9/16" M/P	11	1.00" (25.4)	2.31" (58.7)	0.250" (6.4)	20,000 PSI 1380 bar

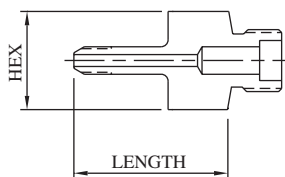

FEMALE H/P CONED AND THREADED TUBE

For Side Connections					
Connection	Suffix	Hex	Length	Port	MAWP*
1/4" H/P	23	0.75" (19.1)	1.01" (25.7)	0.093" (2.4)	20,000 PSI 1380 bar
3/8" H/P	24	1.00" (25.4)	1.17" (29.7)	0.125" (3.2)	20,000 PSI 1380 bar
9/16" H/P	25	1.37" (34.8)	1.25" (31.8)	0.187" (4.7)	20,000 PSI 1380 bar

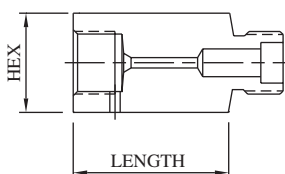

MALE H/P CONED AND THREADED TUBE

For Side Connections					
Connection	Suffix	Hex	Length	Port	MAWP*
1/4" H/P	9	0.75" (19.1)	1.94" (49.3)	0.083" (2.1)	20,000 PSI 1380 bar
3/8" H/P	30	0.75" (19.1)	2.25" (57.2)	0.125" (3.2)	20,000 PSI 1380 bar
9/16" H/P	42	0.75" (19.1)	2.82" (71.6)	0.187" (4.7)	20,000 PSI 1380 bar

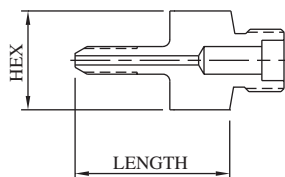

***CAUTION:** The maximum allowable working pressure (MAWP) of the valve shall not exceed the MAWP of the valve series or the selected connection, whichever is less.



All dimensions are for reference only and are subject to change.
Dimensions in parentheses are millimeters (mm).

10,000 PSI (690 BAR) 3-WAY TRUNNION VALVES

Model No. 3K106
3DVK106

*MAWP: 10,000 PSI (690 bar)
Port: 0.375" (9.5 mm)
Cv: 2.40

Materials of Construction:

- 316 cold-worked stainless steel body and side adapters
- 17-4PH stem
- PEEK ball seals
- Viton O-rings
- Teflon back-ups

Ordering information and options on page BV-2

Repair Kit P/N's RK-3K106 and RK-3DVK106 contain stem, trunnion, trunnion seals and seal retainers, o-rings, backups, spring washers, and bearing washers

FEMALE PIPE

Connection	For Side Connections				For Bottom Connection				MAWP*
	Suffix	Hex	Length	Port	Suffix	Hex	Length	Port	
1/8" FNPT	19	1.38" (35.1)	0.47" (11.9)	0.339" (8.6)	19B	1.38" (35.1)	0.47" (11.9)	0.339" (8.6)	15,000 PSI 1030 bar
1/4" FNPT	20	1.38" (35.1)	1.00" (25.4)	0.437" (11.1)	20B	1.38" (35.1)	1.06" (26.9)	0.375" (9.5)	15,000 PSI 1030 bar
3/8" FNPT	21	1.38" (35.1)	1.00" (25.4)	0.500" (12.7)	21B	1.38" (35.1)	1.06" (26.9)	0.375" (9.5)	15,000 PSI 1030 bar
1/2" FNPT	22	1.38" (35.1)	1.00" (25.4)	0.500" (12.7)	22B	1.38" (35.1)	1.06" (26.9)	0.375" (9.5)	15,000 PSI 1030 bar
3/4" FNPT	41	1.38" (35.1)	1.10" (27.9)	0.500" (12.7)	41B	1.38" (35.1)	1.17" (29.7)	0.375" (9.5)	10,000 PSI 690 bar
1" FNPT	45	1.75" (44.5)	1.75" (44.5)	0.500" (12.7)	45B	1.75" (44.5)	1.75" (44.5)	0.500" (12.7)	10,000 PSI 690 bar

MALE PIPE

Connection	For Side Connections				For Bottom Connection				MAWP*
	Suffix	Hex	Length	Port	Suffix	Hex	Length	Port	
1/8" MNPT	4	1.38" (35.1)	1.08" (27.4)	0.187" (4.7)	4B	1.38" (35.1)	1.09" (27.7)	0.187" (4.7)	15,000 PSI 1030 bar
1/4" MNPT	5	1.38" (35.1)	1.22" (31.0)	0.250" (6.4)	5B	1.38" (35.1)	1.31" (33.3)	0.250" (6.4)	15,000 PSI 1030 bar
3/8" MNPT	6	1.38" (35.1)	1.23" (31.2)	0.375" (9.5)	6B	1.38" (35.1)	1.43" (36.3)	0.375" (9.5)	15,000 PSI 1030 bar
1/2" MNPT	7	1.38" (35.1)	1.59" (40.4)	0.375" (9.5)	7B	1.38" (35.1)	1.63" (41.4)	0.375" (9.5)	15,000 PSI 1030 bar
3/4" MNPT	55	1.38" (35.1)	1.62" (41.1)	0.500" (12.7)	55B	1.38" (35.1)	1.65" (41.9)	0.375" (9.5)	10,000 PSI 690 bar
1" MNPT	56	1.50" (38.1)	1.87" (47.5)	0.500" (12.7)	56B	1.50" (38.1)	1.90" (48.3)	0.375" (9.5)	10,000 PSI 690 bar

Mounting:

Panel: 1.06" (26.9 mm) dia
0.25" (6.3 mm) max thickness
Side: 0.28" (7.1 mm) dia

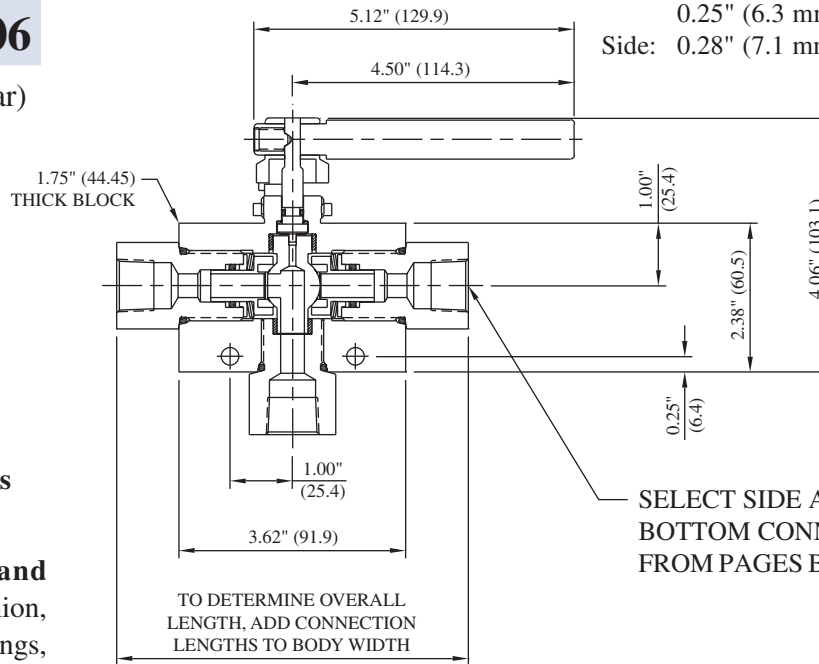

SELECT SIDE AND BOTTOM CONNECTIONS FROM PAGES BV-26 & BV-27

For replacement connections, use prefix number **36-** and suffix number. Ex: 36-20

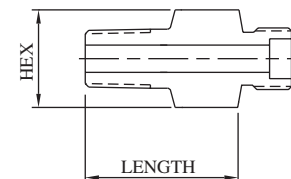
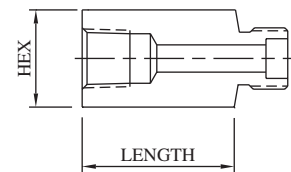

***CAUTION:** The maximum allowable working pressure (MAWP) of the valve shall not exceed the MAWP of the valve series or the selected connection, whichever is less.

All dimensions are for reference only and are subject to change.
Dimensions in parentheses are millimeters (mm).



10,000 PSI (690 BAR) 3-WAY TRUNNION VALVES

Model No. **3K106**
3DVK106

FEMALE SINGLE-FERRULE TUBE

Connection	For Side Connections				For Bottom Connection				MAWP*
	Suffix	Hex	Length	Port	Suffix	Hex	Length	Port	
1/4" SL/P	13	1.38" (35.1)	0.64" (16.3)	0.187" (4.7)	13B	1.38" (35.1)	0.66" (16.8)	0.187" (4.7)	11,500 PSI 790 bar
3/8" SL/P	14	1.38" (35.1)	0.75" (19.1)	0.312" (7.9)	14B	1.38" (35.1)	0.75" (19.1)	0.312" (7.9)	7,500 PSI 520 bar
1/2" L/P	15	1.38" (35.1)	1.06" (26.9)	0.437" (11.1)	15B	1.38" (35.1)	1.06" (26.9)	0.375" (9.5)	5,500 PSI 380 bar

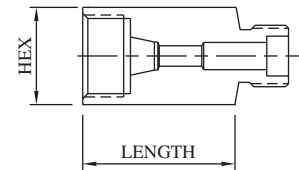

FEMALE M/P CONED AND THREADED TUBE

Connection	For Side Connections				For Bottom Connection				MAWP*
	Suffix	Hex	Length	Port	Suffix	Hex	Length	Port	
1/4" M/P	16	1.38" (35.1)	0.65" (16.5)	0.109" (2.8)	16B	1.38" (35.1)	0.72" (18.3)	0.109" (2.8)	20,000 PSI 1380 bar
3/8" M/P	17	1.38" (35.1)	1.06" (26.9)	0.203" (5.2)	17B	1.38" (35.1)	1.06" (26.9)	0.203" (5.2)	20,000 PSI 1380 bar
9/16" M/P	18	1.38" (35.1)	1.31" (33.3)	0.312" (7.9)	18B	1.38" (35.1)	1.06" (26.9)	0.312" (7.9)	20,000 PSI 1380 bar
3/4" M/P	32	1.38" (35.1)	1.52" (38.6)	0.437" (11.1)	32B	1.38" (35.1)	1.18" (30.0)	0.375" (9.5)	20,000 PSI 1380 bar
1" M/P	43	1.75" (44.5)	1.91" (48.5)	0.500" (12.7)	43B	1.75" (44.5)	1.99" (50.5)	0.375" (9.5)	20,000 PSI 1380 bar

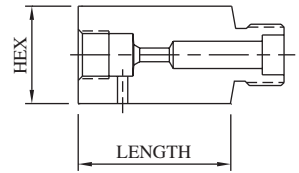

MALE M/P CONED AND THREADED TUBE

Connection	For Side Connections				For Bottom Connection				MAWP*
	Suffix	Hex	Length	Port	Suffix	Hex	Length	Port	
1/4" M/P	8	1.38" (35.1)	1.91" (48.5)	0.109" (2.8)	8B	1.38" (35.1)	1.93" (49.0)	0.109" (2.8)	20,000 PSI 1380 bar
3/8" M/P	10	1.38" (35.1)	1.87" (47.5)	0.203" (5.2)	10B	1.38" (35.1)	2.17" (55.1)	0.203" (5.2)	20,000 PSI 1380 bar
9/16" M/P	11	1.38" (35.1)	3.21" (81.5)	0.312" (7.9)	11B	1.38" (35.1)	2.18" (55.4)	0.312" (7.9)	20,000 PSI 1380 bar
3/4" M/P	37	1.38" (35.1)	3.54" (89.9)	0.437" (11.1)	37B	1.38" (35.1)	5.06" (128.5)	0.437" (11.1)	20,000 PSI 1380 bar
1" M/P	49	1.38" (35.1)	3.20" (81.3)	0.500" (12.7)	49B	1.38" (35.1)	3.25" (82.6)	0.500" (12.7)	20,000 PSI 1380 bar

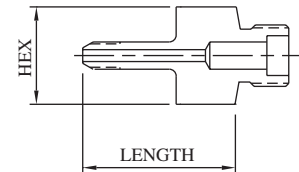

FEMALE H/P CONED AND THREADED TUBE

Connection	For Side Connections				For Bottom Connection				MAWP*
	Suffix	Hex	Length	Port	Suffix	Hex	Length	Port	
1/4" H/P	23	1.38" (35.1)	0.58" (14.7)	0.093" (2.4)	23B	1.38" (35.1)	0.60" (15.2)	0.093" (2.4)	20,000 PSI 1380 bar
3/8" H/P	24	1.38" (35.1)	0.89" (22.6)	0.125" (3.2)	24B	1.38" (35.1)	0.91" (23.1)	0.125" (3.2)	20,000 PSI 1380 bar
9/16" H/P	25	1.50" (38.1)	0.98" (24.9)	0.187" (4.7)	25B	1.50" (38.1)	1.02" (25.9)	0.187" (4.7)	20,000 PSI 1380 bar

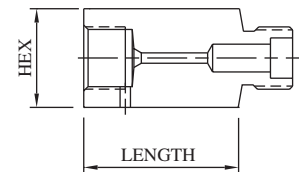

MALE H/P CONED AND THREADED TUBE

Connection	For Side Connections				For Bottom Connection				MAWP*
	Suffix	Hex	Length	Port	Suffix	Hex	Length	Port	
1/4" H/P	9	1.38" (35.1)	2.16" (54.9)	0.083" (2.1)	9B	1.38" (35.1)	2.19" (55.6)	0.083" (2.1)	20,000 PSI 1380 bar
3/8" H/P	30	1.38" (35.1)	2.40" (61.0)	0.125" (3.2)	30B	1.38" (35.1)	2.42" (61.5)	0.125" (3.2)	20,000 PSI 1380 bar
9/16" H/P	42	1.38" (35.1)	2.89" (73.4)	0.187" (4.7)	42B	1.38" (35.1)	2.92" (74.2)	0.187" (4.7)	20,000 PSI 1380 bar

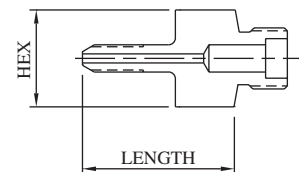

***CAUTION:** The maximum allowable working pressure (MAWP) of the valve shall not exceed the MAWP of the valve series or the selected connection, whichever is less.



All dimensions are for reference only and are subject to change.
Dimensions in parentheses are millimeters (mm).

10,000 PSI (690 BAR) 3-WAY TRUNNION VALVES

**Model No. 3K108
3DVK108**

Mounting:
Side: 0.28" (7.1 mm) dia

*MAWP: 10,000 PSI (690 bar)
Port: 0.500" (12.7 mm)
Cv: 5.00

Materials of Construction:

- 316 cold-worked stainless steel body and side adapters
- 17-4PH stem
- PEEK ball seals
- Glass-filled Teflon stem packings
- Viton O-rings

Ordering information and options on page BV-2

Repair Kit P/N's RK-3K108 and RK-3DVK108 contain trunnion, trunnion seals and seal retainers, o-rings, spring washers, gaskets, stem, stem packings and washers

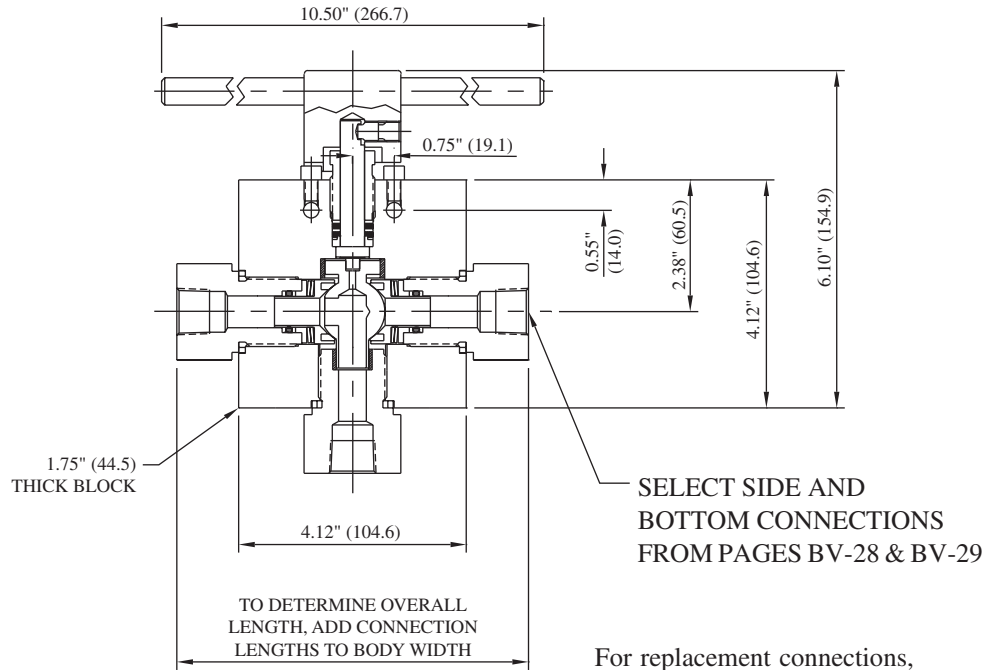

For replacement connections, use prefix number **38-** and suffix number. Ex: 38-20

FEMALE PIPE

Connection	For Side Connections				For Bottom Connection				MAWP*
	Suffix	Hex	Length	Port	Suffix	Hex	Length	Port	
3/8" FNPT	21	1.75" (44.5)	1.11" (28.2)	0.437" (11.1)	21B	1.75" (44.5)	1.19" (30.2)	0.437" (11.1)	15,000 PSI 1030 bar
1/2" FNPT	22	1.75" (44.5)	1.11" (28.2)	0.580" (14.7)	22B	1.75" (44.5)	1.19" (30.2)	0.500" (12.7)	15,000 PSI 1030 bar
3/4" FNPT	41	1.75" (44.5)	1.21" (30.7)	0.580" (14.7)	41B	1.75" (44.5)	1.33" (33.8)	0.500" (12.7)	10,000 PSI 690 bar
1" FNPT	45	1.75" (44.5)	1.37" (34.8)	0.580" (14.7)	45B	1.75" (44.5)	1.70" (43.2)	0.500" (12.7)	10,000 PSI 690 bar
1-1/2" FNPT	46	2.50" (63.5)	1.75" (44.5)	0.580" (14.7)	46B	2.50" (63.5)	1.75" (44.5)	0.500" (12.7)	5,000 PSI 340 bar

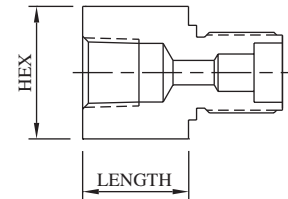

MALE PIPE

Connection	For Side Connections				For Bottom Connection				MAWP*
	Suffix	Hex	Length	Port	Suffix	Hex	Length	Port	
3/8" MNPT	6	1.75" (44.5)	1.43" (36.3)	0.375" (9.5)	6B	1.75" (44.5)	1.43" (36.3)	0.375" (9.5)	15,000 PSI 1030 bar
1/2" MNPT	7	1.75" (44.5)	1.65" (41.9)	0.580" (14.7)	7B	1.75" (44.5)	1.67" (42.4)	0.500" (12.7)	15,000 PSI 1030 bar
3/4" MNPT	55	1.75" (44.5)	1.67" (42.4)	0.580" (14.7)	55B	1.75" (44.5)	1.75" (44.5)	0.500" (12.7)	10,000 PSI 690 bar
1" MNPT	56	1.75" (44.5)	1.85" (47.0)	0.580" (14.7)	56B	1.75" (44.5)	1.86" (47.2)	0.500" (12.7)	10,000 PSI 690 bar
1-1/2" MNPT	121	2.12" (53.8)	1.89" (48.0)	0.580" (14.7)	121B	2.12" (53.8)	1.89" (48.0)	0.500" (12.7)	5,000 PSI 340 bar

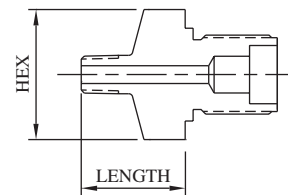

***CAUTION:** The maximum allowable working pressure (MAWP) of the valve shall not exceed the MAWP of the valve series or the selected connection, whichever is less.



All dimensions are for reference only and are subject to change.
Dimensions in parentheses are millimeters (mm).



10,000 PSI (690 BAR) 3-WAY TRUNNION VALVES

Model No. 3K108
3DVK108

FEMALE SINGLE-FERRULE TUBE

Connection	For Side Connections				For Bottom Connection				MAWP*
	Suffix	Hex	Length	Port	Suffix	Hex	Length	Port	
3/8" SL/P	14	1.75" (44.5)	1.12" (28.4)	0.312" (7.9)	14B	1.75" (44.5)	1.08" (27.4)	0.312" (7.9)	7,500 PSI 520 bar
1/2" L/P	15	1.75" (44.5)	1.00" (25.4)	0.437" (11.1)	15B	1.75" (44.5)	1.00" (25.4)	0.437" (11.1)	5,500 PSI 380 bar

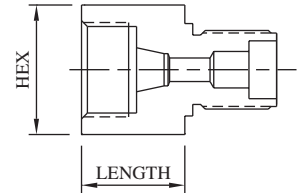

FEMALE M/P CONED AND THREADED TUBE

Connection	For Side Connections				For Bottom Connection				MAWP*
	Suffix	Hex	Length	Port	Suffix	Hex	Length	Port	
3/8" M/P	17	1.75" (44.5)	0.62" (15.7)	0.203" (5.2)	17B	1.75" (44.5)	0.62" (15.7)	0.203" (5.2)	20,000 PSI 1380 bar
9/16" M/P	18	(44.5)	0.94" (23.9)	0.312" (7.9)	18B	1.75" (44.5)	0.94" (23.9)	0.312" (7.9)	20,000 PSI 1380 bar
3/4" M/P	32	1.75" (44.5)	1.36" (34.5)	0.515" (13.1)	32B	1.75" (44.5)	0.89" (22.6)	0.500" (12.7)	20,000 PSI 1380 bar
1" M/P	43	1.75" (44.5)	1.66" (42.2)	0.562" (14.3)	43B	1.75" (44.5)	1.74" (44.2)	0.500" (12.7)	20,000 PSI 1380 bar

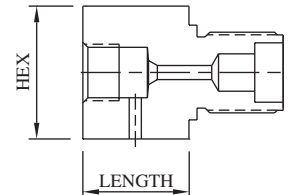

MALE M/P CONED AND THREADED TUBE

Connection	For Side Connections				For Bottom Connection				MAWP*
	Suffix	Hex	Length	Port	Suffix	Hex	Length	Port	
3/8" M/P	10	1.75" (44.5)	2.36" (59.9)	0.203" (5.2)	10B	1.75" (44.5)	2.23" (56.6)	0.203" (5.2)	20,000 PSI 1380 bar
9/16" M/P	11	1.75" (44.5)	2.64" (67.1)	0.312" (7.9)	11B	1.75" (44.5)	2.64" (67.1)	0.312" (7.9)	20,000 PSI 1380 bar
3/4" M/P	37	1.75" (44.5)	2.75" (69.9)	0.437" (11.1)	37B	1.75" (44.5)	2.75" (69.9)	0.437" (11.1)	20,000 PSI 1380 bar
1" M/P	49	1.75" (44.5)	3.21" (81.5)	0.580" (14.7)	49B	1.75" (44.5)	3.21" (81.5)	0.500" (12.7)	20,000 PSI 1380 bar

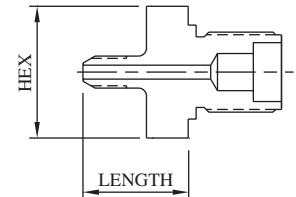

FEMALE H/P CONED AND THREADED TUBE

Connection	For Side Connections				For Bottom Connection				MAWP*
	Suffix	Hex	Length	Port	Suffix	Hex	Length	Port	
3/8" H/P	24	1.75" (44.5)	0.75" (19.1)	0.125" (3.2)	24B	1.75" (44.5)	0.75" (19.1)	0.125" (3.2)	20,000 PSI 1380 bar
9/16" H/P		1.75" (44.5)	1.00" (25.4)	0.187" (4.7)	25B	1.75" (44.5)	1.00" (25.4)	0.187" (4.7)	20,000 PSI 1380 bar

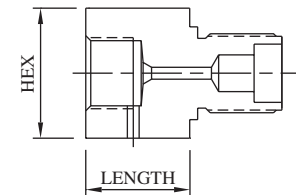

MALE H/P CONED AND THREADED TUBE

Connection	For Side Connections				For Bottom Connection				MAWP*
	Suffix	Hex	Length	Port	Suffix	Hex	Length	Port	
3/8" H/P	30	1.75" (44.5)	2.45" (62.2)	0.125" (3.2)	30B	1.75" (44.5)	2.45" (62.2)	0.125" (3.2)	20,000 PSI 1380 bar
9/16" H/P	42	1.75" (44.5)	2.96" (75.2)	0.187" (4.7)	42B	1.75" (44.5)	2.96" (75.2)	0.187" (4.7)	20,000 PSI 1380 bar

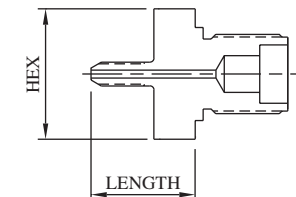

***CAUTION:** The maximum allowable working pressure (MAWP) of the valve shall not exceed the MAWP of the valve series or the selected connection, whichever is less.



All dimensions are for reference only and are subject to change.
Dimensions in parentheses are millimeters (mm).

12,000 PSI (830 BAR) 3-WAY TRUNNION VALVES

**Model No. 3K123
3DVK123**

*MAWP: 12,000 PSI (830 bar)
Port: 0.187" (4.7 mm)
Cv: 0.56

Materials of Construction:

- 316 cold-worked stainless steel body and side adapters
- 17-4PH stem
- PEEK ball seals
- Viton O-rings
- Teflon back-ups

Ordering information and options on page BV-2

Repair Kit P/N's RK-3K123 and RK-3DVK123 contain stem, trunnion, trunnion seals and seal retainers, o-rings, backups, spring washers, and bearing washers

Mounting:

Panel: 1.06" (26.9 mm) dia
0.25" (6.4 mm) max thickness
Top: 1/4"-20 UNC

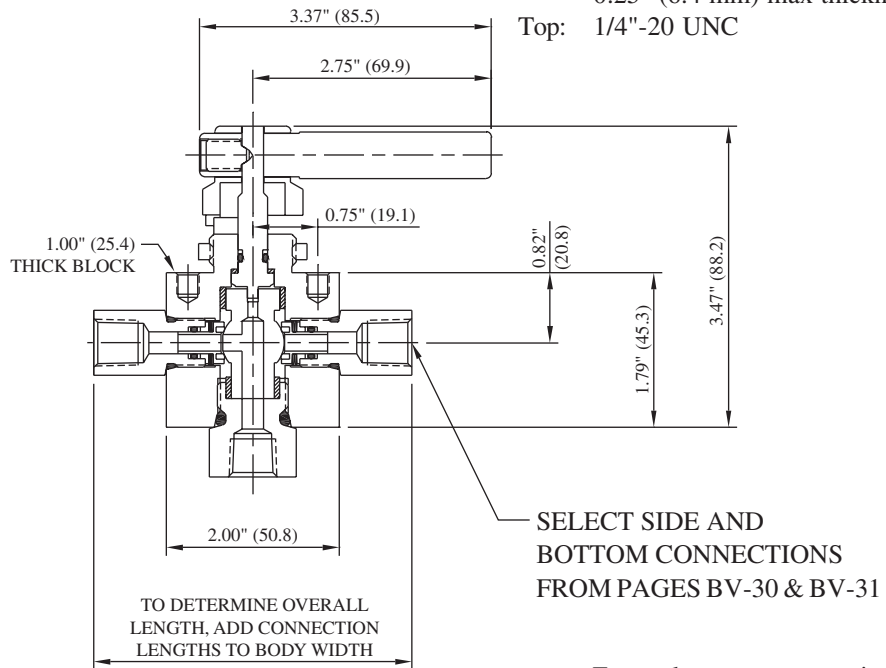

For replacement connections, use prefix number **3-** and suffix number. Ex: 3-20

FEMALE PIPE

Connection	For Side Connections				For Bottom Connection				MAWP*
	Suffix	Hex	Length	Port	Suffix	Hex	Length	Port	
1/8" FNPT	19	0.75" (19.1)	0.60" (15.2)	0.250" (6.4)	19B	1.00" (25.4)	0.63" (16.0)	0.250" (6.4)	15,000 PSI 1030 bar
1/4" FNPT	20	0.75" (19.1)	0.60" (15.2)	0.250" (6.4)	20B	1.00" (25.4)	0.55" (14.0)	0.250" (6.4)	15,000 PSI 1030 bar
3/8" FNPT	21	1.00" (25.4)	1.01" (25.7)	0.250" (6.4)	21B	1.00" (25.4)	1.01" (25.7)	0.250" (6.4)	15,000 PSI 1030 bar
1/2" FNPT	22	1.00" (25.4)	1.01" (25.7)	0.250" (6.4)	22B	1.00" (25.4)	1.16" (29.5)	0.250" (6.4)	15,000 PSI 1030 bar

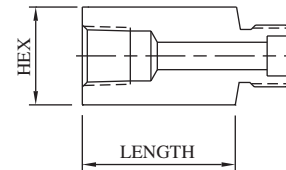

MALE PIPE

Connection	For Side Connections				For Bottom Connection				MAWP*
	Suffix	Hex	Length	Port	Suffix	Hex	Length	Port	
1/8" MNPT	4	0.75" (19.1)	1.01" (25.7)	0.125" (3.2)	4B	1.00" (25.4)	0.93" (23.6)	0.125" (3.2)	15,000 PSI 1030 bar
1/4" MNPT	5	0.75" (19.1)	1.01" (25.7)	0.250" (6.4)	5B	1.00" (25.4)	1.05" (26.7)	0.250" (6.4)	15,000 PSI 1030 bar
3/8" MNPT	6	0.75" (19.1)	1.01" (25.7)	0.250" (6.4)	6B	1.00" (25.4)	1.01" (25.7)	0.250" (6.4)	15,000 PSI 1030 bar
1/2" MNPT	7	1.00" (25.4)	1.26" (32.0)	0.250" (6.4)	7B	1.00" (25.4)	1.29" (32.8)	0.250" (6.4)	15,000 PSI 1030 bar

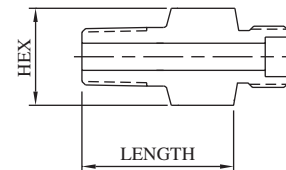

***CAUTION:** The maximum allowable working pressure (MAWP) of the valve shall not exceed the MAWP of the valve series or the selected connection, whichever is less.

All dimensions are for reference only and are subject to change.
Dimensions in parentheses are millimeters (mm).



12,000 PSI (830 BAR) 3-WAY TRUNNION VALVES

Model No. **3K123**
3DVK123

FEMALE SINGLE-FERRULE TUBE

Connection	For Side Connections				For Bottom Connection				MAWP*
	Suffix	Hex	Length	Port	Suffix	Hex	Length	Port	
1/8" L/P	12	0.75" (19.1)	0.78" (19.8)	0.093" (2.4)	12B	1.00" (25.4)	0.55" (14.0)	0.093" (2.4)	15,000 PSI 1030 bar
1/4" SL/P	13	0.75" (19.1)	1.03" (26.2)	0.125" (3.2)	13B	1.00" (25.4)	0.83" (21.0)	0.125" (3.2)	11,500 PSI 790 bar
3/8" SL/P	14	0.75" (19.1)	1.03" (26.2)	0.250" (6.4)	14B	1.00" (25.4)	1.01" (25.7)	0.250" (6.4)	7,500 PSI 520 bar
1/2" L/P	15	1.00" (25.4)	1.03" (26.2)	0.250" (6.4)	15B	1.00" (25.4)	1.01" (25.7)	0.250" (6.4)	5,500 PSI 380 bar

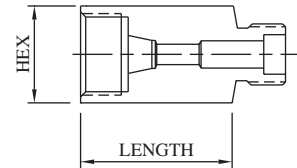

FEMALE M/P CONED AND THREADED TUBE

Connection	For Side Connections				For Bottom Connection				MAWP*
	Suffix	Hex	Length	Port	Suffix	Hex	Length	Port	
1/4" M/P	16	0.75" (19.1)	0.74" (18.8)	0.109" (2.8)	16B	1.00" (25.4)	0.76" (19.3)	0.109" (2.8)	20,000 PSI 1380 bar
3/8" M/P	17	0.75" (19.1)	1.01" (25.7)	0.203" (5.2)	17B	1.00" (25.4)	0.83" (21.0)	0.203" (5.2)	20,000 PSI 1380 bar
9/16" M/P	18	1.00" (25.4)	1.26" (32.0)	0.250" (6.4)	18B	1.00" (25.4)	1.01" (25.7)	0.312" (7.9)	20,000 PSI 1380 bar

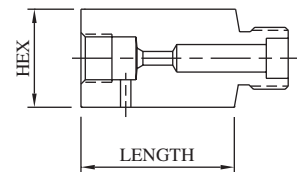

MALE M/P CONED AND THREADED TUBE

Connection	For Side Connections				For Bottom Connection				MAWP*
	Suffix	Hex	Length	Port	Suffix	Hex	Length	Port	
1/4" M/P	8	0.75" (19.1)	1.88" (47.8)	0.109" (2.8)	8B	1.00" (25.4)	1.88" (47.8)	0.109" (2.8)	20,000 PSI 1380 bar
3/8" M/P	10	0.75" (19.1)	2.00" (50.8)	0.203" (5.2)	10B	1.00" (25.4)	2.00" (50.8)	0.203" (5.2)	20,000 PSI 1380 bar
9/16" M/P	11	1.00" (25.4)	2.31" (58.7)	0.250" (6.4)	11B	1.12" (28.4)	2.95" (74.9)	0.312" (7.9)	20,000 PSI 1380 bar

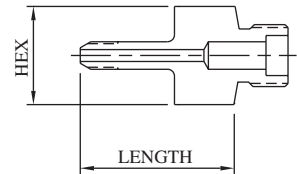

FEMALE H/P CONED AND THREADED TUBE

Connection	For Side Connections				For Bottom Connection				MAWP*
	Suffix	Hex	Length	Port	Suffix	Hex	Length	Port	
1/4" H/P	23	0.75" (19.1)	1.01" (25.7)	0.093" (2.4)	23B	1.00" (25.4)	0.89" (22.6)	0.093" (2.4)	20,000 PSI 1380 bar
3/8" H/P	24	1.00" (25.4)	1.17" (29.7)	0.125" (3.2)	24B	1.00" (25.4)	0.99" (25.1)	0.125" (3.2)	20,000 PSI 1380 bar
9/16" H/P	25	1.37" (34.8)	1.25" (31.8)	0.187" (4.7)	25B	1.37" (34.8)	1.25" (31.8)	0.187" (4.7)	20,000 PSI 1380 bar

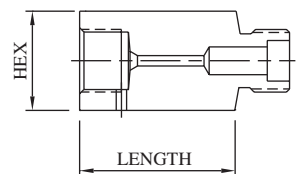

MALE H/P CONED AND THREADED TUBE

Connection	For Side Connections				For Bottom Connection				MAWP*
	Suffix	Hex	Length	Port	Suffix	Hex	Length	Port	
1/4" H/P	9	0.75" (19.1)	1.94" (49.3)	0.083" (2.1)	9B	1.00" (25.4)	2.12" (53.8)	0.083" (2.1)	20,000 PSI 1380 bar
3/8" H/P	30	0.75" (19.1)	2.25" (57.2)	0.125" (3.2)	30B	1.00" (25.4)	2.35" (59.7)	0.125" (3.2)	20,000 PSI 1380 bar
9/16" H/P	42	0.75" (19.1)	2.82" (71.6)	0.187" (4.7)	42B	1.00" (25.4)	2.88" (73.2)	0.187" (4.7)	20,000 PSI 1380 bar

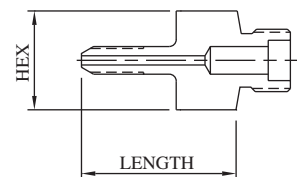

***CAUTION:** The maximum allowable working pressure (MAWP) of the valve shall not exceed the MAWP of the valve series or the selected connection, whichever is less.



All dimensions are for reference only and are subject to change.
Dimensions in parentheses are millimeters (mm).

20,000 PSI (1380 BAR) 3-WAY TRUNNION VALVES

**Model No. 3K203
3DVK203**

*MAWP: 20,000 PSI (1380 bar)
Port: 0.187" (4.7 mm)
Cv: 0.56

Materials of Construction:

- 316 cold-worked stainless steel body and side adapters
- 17-4PH stem
- PEEK ball seals
- Viton O-rings
- Teflon back-ups

Ordering information and options on page BV-2

Repair Kit P/N's RK-3K203 and RK-3DVK203 contain stem, trunnion, trunnion seals and seal retainers, o-rings, backups, spring washers, and bearing washers

Mounting:

Panel: 1.06" (26.9 mm) dia
0.25" (6.4 mm) max thickness
Top: 1/4"-20 UNC

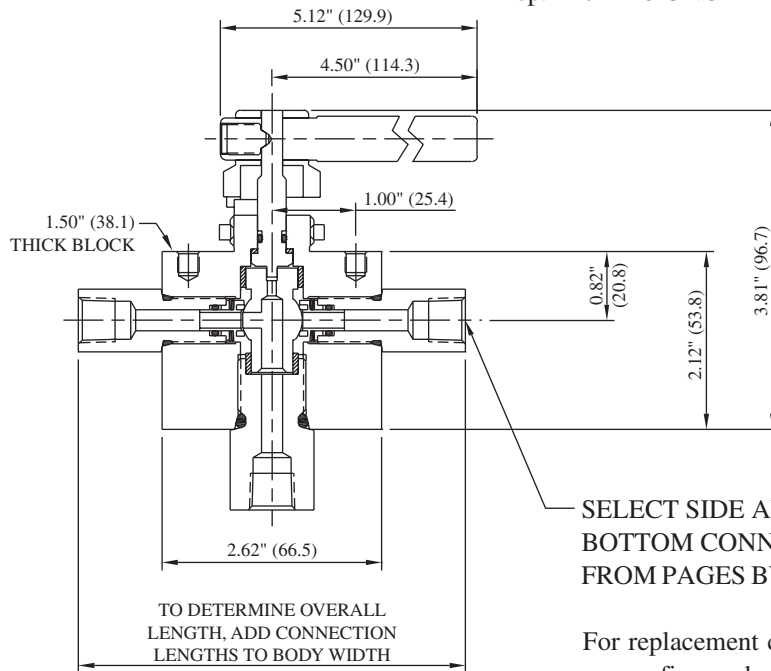

SELECT SIDE AND BOTTOM CONNECTIONS FROM PAGES BV-32 & BV-33

For replacement connections, use prefix number **33-** and suffix number. Ex: 33-20

FEMALE PIPE

Connection	For Side Connections				For Bottom Connection				MAWP*
	Suffix	Hex	Length	Port	Suffix	Hex	Length	Port	
1/8" FNPT	19	0.75" (19.1)	1.00" (25.4)	0.250" (6.4)	19B	1.00" (25.4)	0.50" (12.7)	0.187" (4.7)	15,000 PSI 1030 bar
1/4" FNPT	20	0.75" (19.1)	1.00" (25.4)	0.250" (6.4)	20B	1.00" (25.4)	1.06" (26.9)	0.250" (6.4)	15,000 PSI 1030 bar
3/8" FNPT	21	1.00" (25.4)	1.01" (25.7)	0.250" (6.4)	21B	1.00" (25.4)	1.06" (26.9)	0.250" (6.4)	15,000 PSI 1030 bar
1/2" FNPT	22	1.38" (35.1)	1.13" (28.7)	0.250" (6.4)	22B	1.37" (34.8)	1.12" (28.4)	0.250" (6.4)	15,000 PSI 1030 bar

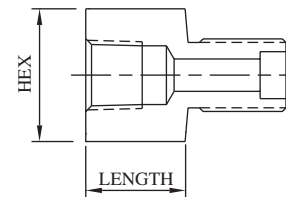

MALE PIPE

Connection	For Side Connections				For Bottom Connection				MAWP*
	Suffix	Hex	Length	Port	Suffix	Hex	Length	Port	
1/8" MNPT	4	0.75" (19.1)	1.11" (28.2)	0.188" (4.8)	4B	1.00" (25.4)	1.08" (27.4)	0.187" (4.7)	15,000 PSI 1030 bar
1/4" MNPT	5	0.75" (19.1)	1.25" (31.8)	0.250" (6.4)	5B	1.00" (25.4)	1.08" (27.4)	0.250" (6.4)	15,000 PSI 1030 bar
3/8" MNPT	6	0.75" (19.1)	1.25" (31.8)	0.250" (6.4)	6B	1.00" (25.4)	1.30" (33.0)	0.250" (6.4)	15,000 PSI 1030 bar
1/2" MNPT	7	1.00" (25.4)	1.60" (40.6)	0.250" (6.4)	7B	1.00" (25.4)	1.52" (38.6)	0.250" (6.4)	15,000 PSI 1030 bar

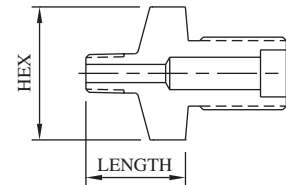

***CAUTION:** The maximum allowable working pressure (MAWP) of the valve shall not exceed the MAWP of the valve series or the selected connection, whichever is less.

All dimensions are for reference only and are subject to change.
Dimensions in parentheses are millimeters (mm).



20,000 PSI (1380 BAR) 3-WAY TRUNNION VALVES

Model No. **3K203**
3DVK203

FEMALE M/P CONED AND THREADED TUBE

Connection	For Side Connections				For Bottom Connection				MAWP*
	Suffix	Hex	Length	Port	Suffix	Hex	Length	Port	
1/4" M/P	16	0.75" (19.1)	1.00" (25.4)	0.125" (3.2)	16B	1.00" (25.4)	1.00" (25.4)	0.125" (3.2)	20,000 PSI 1380 bar
3/8" M/P	17	0.75" (19.1)	1.00" (25.4)	0.203" (5.2)	17B	1.00" (25.4)	1.00" (25.4)	0.203" (5.2)	20,000 PSI 1380 bar
9/16" M/P	18	1.00" (25.4)	1.25" (31.8)	0.250" (6.4)	18B	1.00" (25.4)	1.25" (31.8)	0.312" (7.9)	20,000 PSI 1380 bar

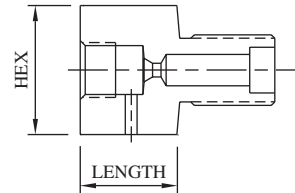

MALE M/P CONED AND THREADED TUBE

Connection	For Side Connections				For Bottom Connection				MAWP*
	Suffix	Hex	Length	Port	Suffix	Hex	Length	Port	
1/4" M/P	8	0.75" (19.1)	1.88" (47.8)	0.109" (2.8)	8B	1.00" (25.4)	1.88" (47.8)	0.109" (2.8)	20,000 PSI 1380 bar
3/8" M/P	10	0.75" (19.1)	1.87" (47.5)	0.203" (5.2)	10B	1.00" (25.4)	2.13" (54.1)	0.203" (5.2)	20,000 PSI 1380 bar
9/16" M/P	11	0.75" (19.1)	2.15" (54.6)	0.203" (5.2)	11B	1.12" (28.4)	2.12" (53.8)	0.312" (7.9)	20,000 PSI 1380 bar

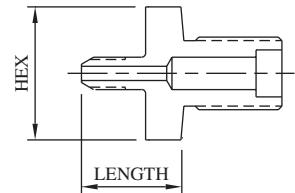

FEMALE H/P CONED AND THREADED TUBE

Connection	For Side Connections				For Bottom Connection				MAWP*
	Suffix	Hex	Length	Port	Suffix	Hex	Length	Port	
1/4" H/P	23	0.75" (19.1)	1.00" (25.4)	0.093" (2.4)	23B	1.00" (25.4)	0.81" (20.6)	0.093" (2.4)	20,000 PSI 1380 bar
3/8" H/P	24	1.00" (25.4)	1.00" (25.4)	0.125" (3.2)	24B	1.00" (25.4)	0.94" (23.9)	0.125" (3.2)	20,000 PSI 1380 bar
9/16" H/P	25	1.38" (35.1)	1.12" (28.4)	0.187" (4.7)	25B	1.38" (35.1)	1.19" (30.2)	0.187" (4.7)	20,000 PSI 1380 bar

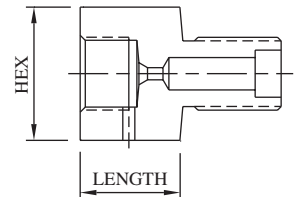

MALE H/P CONED AND THREADED TUBE

Connection	For Side Connections				For Bottom Connection				MAWP*
	Suffix	Hex	Length	Port	Suffix	Hex	Length	Port	
1/4" H/P	9	0.75" (19.1)	1.91" (48.5)	0.083" (2.1)	9B	1.00" (25.4)	1.91" (48.5)	0.083" (2.1)	20,000 PSI 1380 bar
3/8" H/P	30	0.75" (19.1)	2.34" (59.4)	0.125" (3.2)	30B	1.00" (25.4)	2.39" (60.7)	0.125" (3.2)	20,000 PSI 1380 bar
9/16" H/P	42	0.75" (19.1)	2.72" (69.1)	0.187" (4.7)	42B	1.00" (25.4)	2.78" (70.6)	0.187" (4.7)	20,000 PSI 1380 bar

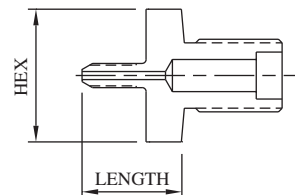

***CAUTION:** The maximum allowable working pressure (MAWP) of the valve shall not exceed the MAWP of the valve series or the selected connection, whichever is less.



All dimensions are for reference only and are subject to change.
Dimensions in parentheses are millimeters (mm).

20,000 PSI (1380 BAR) 3-WAY TRUNNION VALVES

Model No. 3K206
3DVK206

*MAWP: 20,000 PSI (1380 bar)
Port: 0.375" (9.5 mm)
Cv: 2.40

Materials of Construction:

- 316 cold-worked stainless steel body and side adapters
- 17-4PH stem
- PEEK ball seals
- Viton O-rings
- Teflon back-ups

Ordering information and options on page BV-2

Repair Kit P/N's RK-3K206 and RK-3DVK206 contain stem, trunnion, trunnion seals and seal retainers, o-rings, backups, spring washers, and bearing washers

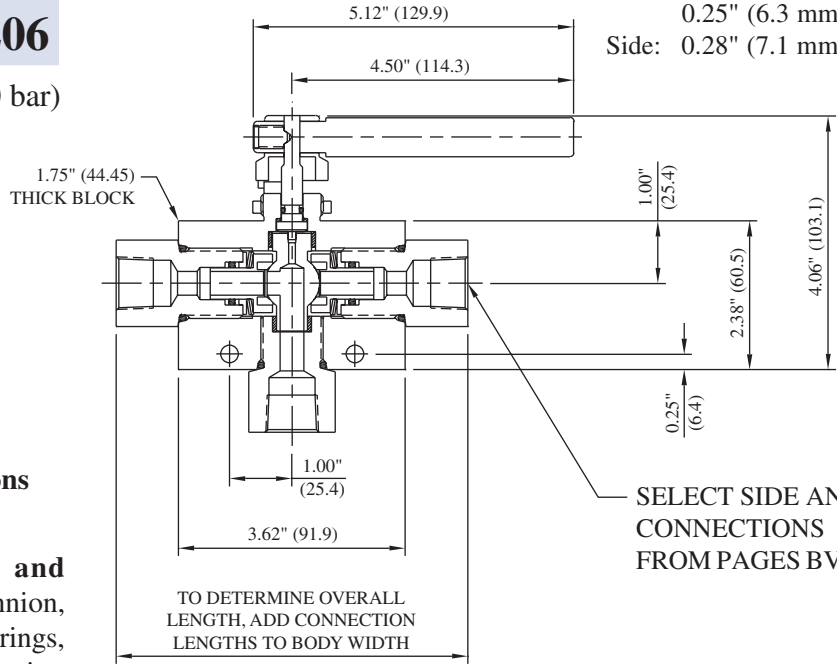

Mounting:

Panel: 1.06" (26.9 mm) dia
0.25" (6.3 mm) max thickness
Side: 0.28" (7.1 mm) dia

SELECT SIDE AND BOTTOM CONNECTIONS FROM PAGES BV-34 & BV-35

For replacement connections, use prefix number **36-** and suffix number. Ex: 36-20

FEMALE PIPE

Connection	For Side Connections				For Bottom Connection				MAWP*
	Suffix	Hex	Length	Port	Suffix	Hex	Length	Port	
1/8" FNPT	19	1.38" (35.1)	0.47" (11.9)	0.339" (8.6)	19B	1.38" (35.1)	0.47" (11.9)	0.339" (8.6)	15,000 PSI 1030 bar
1/4" FNPT	20	1.38" (35.1)	1.00" (25.4)	0.437" (11.1)	20B	1.38" (35.1)	1.06" (26.9)	0.375" (9.5)	15,000 PSI 1030 bar
3/8" FNPT	21	1.38" (35.1)	1.00" (25.4)	0.500" (12.7)	21B	1.38" (35.1)	1.06" (26.9)	0.375" (9.5)	15,000 PSI 1030 bar
1/2" FNPT	22	1.38" (35.1)	1.00" (25.4)	0.500" (12.7)	22B	1.38" (35.1)	1.06" (26.9)	0.375" (9.5)	15,000 PSI 1030 bar
3/4" FNPT	41	1.38" (35.1)	1.10" (27.9)	0.500" (12.7)	41B	1.38" (35.1)	1.17" (29.7)	0.375" (9.5)	10,000 PSI 690 bar
1" FNPT	45	1.75" (44.5)	1.75" (44.5)	0.500" (12.7)	45B	1.75" (44.5)	1.75" (44.5)	0.500" (12.7)	10,000 PSI 690 bar

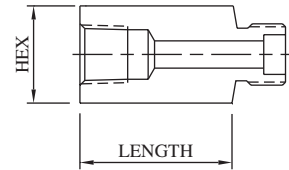

MALE PIPE

Connection	For Side Connections				For Bottom Connection				MAWP*
	Suffix	Hex	Length	Port	Suffix	Hex	Length	Port	
1/8" MNPT	4	1.38" (35.1)	1.08" (27.4)	0.187" (4.7)	4B	1.38" (35.1)	1.09" (27.7)	0.187" (4.7)	15,000 PSI 1030 bar
1/4" MNPT	5	1.38" (35.1)	1.22" (31.0)	0.250" (6.4)	5B	1.38" (35.1)	1.31" (33.3)	0.250" (6.4)	15,000 PSI 1030 bar
3/8" MNPT	6	1.38" (35.1)	1.23" (31.2)	0.375" (9.5)	6B	1.38" (35.1)	1.43" (36.3)	0.375" (9.5)	15,000 PSI 1030 bar
1/2" MNPT	7	1.38" (35.1)	1.59" (40.4)	0.375" (9.5)	7B	1.38" (35.1)	1.63" (41.4)	0.375" (9.5)	15,000 PSI 1030 bar
3/4" MNPT	55	1.38" (35.1)	1.62" (41.1)	0.500" (12.7)	55B	1.38" (35.1)	1.65" (41.9)	0.375" (9.5)	10,000 PSI 690 bar
1" MNPT	56	1.50" (38.1)	1.87" (47.5)	0.500" (12.7)	56B	1.50" (38.1)	1.90" (48.3)	0.375" (9.5)	10,000 PSI 690 bar

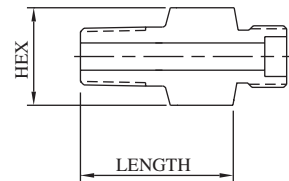

***CAUTION:** The maximum allowable working pressure (MAWP) of the valve shall not exceed the MAWP of the valve series or the selected connection, whichever is less.

All dimensions are for reference only and are subject to change.
Dimensions in parentheses are millimeters (mm).



20,000 PSI (1380 BAR) 3-WAY TRUNNION VALVES

Model No. **3K206**
3DVK206

FEMALE SINGLE-FERRULE TUBE

Connection	For Side Connections				For Bottom Connection				MAWP*
	Suffix	Hex	Length	Port	Suffix	Hex	Length	Port	
1/4" SL/P	13	1.38" (35.1)	0.64" (16.3)	0.187" (4.7)	13B	1.38" (35.1)	0.66" (16.8)	0.187" (4.7)	11,500 PSI 790 bar
3/8" SL/P	14	1.38" (35.1)	0.75" (19.1)	0.312" (7.9)	14B	1.38" (35.1)	0.75" (19.1)	0.312" (7.9)	7,500 PSI 520 bar
1/2" L/P	15	1.38" (35.1)	1.06" (26.9)	0.437" (11.1)	15B	1.38" (35.1)	1.06" (26.9)	0.375" (9.5)	5,500 PSI 380 bar

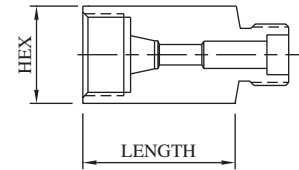

FEMALE M/P CONED AND THREADED TUBE

Connection	For Side Connections				For Bottom Connection				MAWP*
	Suffix	Hex	Length	Port	Suffix	Hex	Length	Port	
1/4" M/P	16	1.38" (35.1)	0.65" (16.5)	0.109" (2.8)	16B	1.38" (35.1)	0.72" (18.3)	0.109" (2.8)	20,000 PSI 1380 bar
3/8" M/P	17	1.38" (35.1)	1.06" (26.9)	0.203" (5.2)	17B	1.38" (35.1)	1.06" (26.9)	0.203" (5.2)	20,000 PSI 1380 bar
9/16" M/P	18	1.38" (35.1)	1.31" (33.3)	0.312" (7.9)	18B	1.38" (35.1)	1.06" (26.9)	0.312" (7.9)	20,000 PSI 1380 bar
3/4" M/P	32	1.38" (35.1)	1.52" (38.6)	0.437" (11.1)	32B	1.38" (35.1)	1.18" (30.0)	0.375" (9.5)	20,000 PSI 1380 bar
1" M/P	43	1.75" (44.5)	1.91" (48.5)	0.500" (12.7)	43B	1.75" (44.5)	1.99" (50.5)	0.375" (9.5)	20,000 PSI 1380 bar

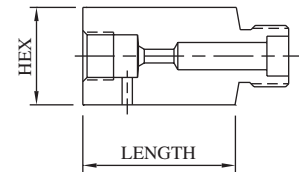

MALE M/P CONED AND THREADED TUBE

Connection	For Side Connections				For Bottom Connection				MAWP*
	Suffix	Hex	Length	Port	Suffix	Hex	Length	Port	
1/4" M/P	8	1.38" (35.1)	1.91" (48.5)	0.109" (2.8)	8B	1.38" (35.1)	1.93" (49.0)	0.109" (2.8)	20,000 PSI 1380 bar
3/8" M/P	10	1.38" (35.1)	1.87" (47.5)	0.203" (5.2)	10B	1.38" (35.1)	2.17" (55.1)	0.203" (5.2)	20,000 PSI 1380 bar
9/16" M/P	11	1.38" (35.1)	3.21" (81.5)	0.312" (7.9)	11B	1.38" (35.1)	2.18" (55.4)	0.312" (7.9)	20,000 PSI 1380 bar
3/4" M/P	37	1.38" (35.1)	3.54" (89.9)	0.437" (11.1)	37B	1.38" (35.1)	5.06" (128.5)	0.437" (11.1)	20,000 PSI 1380 bar
1" M/P	49	1.38" (35.1)	3.20" (81.3)	0.500" (12.7)	49B	1.38" (35.1)	3.25" (82.6)	0.500" (12.7)	20,000 PSI 1380 bar

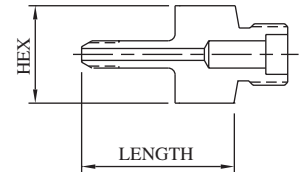

FEMALE H/P CONED AND THREADED TUBE

Connection	For Side Connections				For Bottom Connection				MAWP*
	Suffix	Hex	Length	Port	Suffix	Hex	Length	Port	
1/4" H/P	23	1.38" (35.1)	0.58" (14.7)	0.093" (2.4)	23B	1.38" (35.1)	0.60" (15.2)	0.093" (2.4)	20,000 PSI 1380 bar
3/8" H/P	24	1.38" (35.1)	0.89" (22.6)	0.125" (3.2)	24B	1.38" (35.1)	0.91" (23.1)	0.125" (3.2)	20,000 PSI 1380 bar
9/16" H/P	25	1.50" (38.1)	0.98" (24.9)	0.187" (4.7)	25B	1.50" (38.1)	1.02" (25.9)	0.187" (4.7)	20,000 PSI 1380 bar

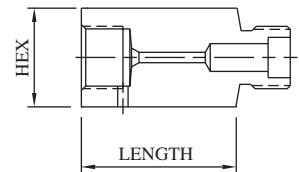

MALE H/P CONED AND THREADED TUBE

Connection	For Side Connections				For Bottom Connection				MAWP*
	Suffix	Hex	Length	Port	Suffix	Hex	Length	Port	
1/4" H/P	9	1.38" (35.1)	2.16" (54.9)	0.083" (2.1)	9B	1.38" (35.1)	2.19" (55.6)	0.083" (2.1)	20,000 PSI 1380 bar
3/8" H/P	30	1.38" (35.1)	2.40" (61.0)	0.125" (3.2)	30B	1.38" (35.1)	2.42" (61.5)	0.125" (3.2)	20,000 PSI 1380 bar
9/16" H/P	42	1.38" (35.1)	2.89" (73.4)	0.187" (4.7)	42B	1.38" (35.1)	2.92" (74.2)	0.187" (4.7)	20,000 PSI 1380 bar

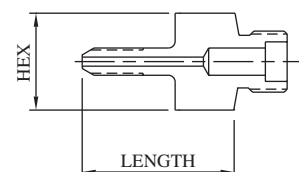

***CAUTION:** The maximum allowable working pressure (MAWP) of the valve shall not exceed the MAWP of the valve series or the selected connection, whichever is less.



All dimensions are for reference only and are subject to change.
Dimensions in parentheses are millimeters (mm).

10,000 PSI (690 BAR) 4-WAY TRUNNION VALVES

Model No. 4K103

*MAWP: 10,000 PSI (690 bar)
 Port: 0.187" (4.7 mm)
 Cv: 0.56

Materials of Construction:

- 316 cold-worked stainless steel body and side adapters
- 17-4PH stem
- PEEK ball seals
- Viton O-rings
- Teflon back-ups

Ordering information and options on page BV-2

Repair Kit P/N RK-4K103 contains stem, trunnion, trunnion seals and seal retainers, o-rings, backups, spring washers, and bearing washers

Mounting:

Panel: 1.06" (26.9 mm) dia
 0.25" (6.4 mm) max thickness
 Top: 1/4"-20 UNC

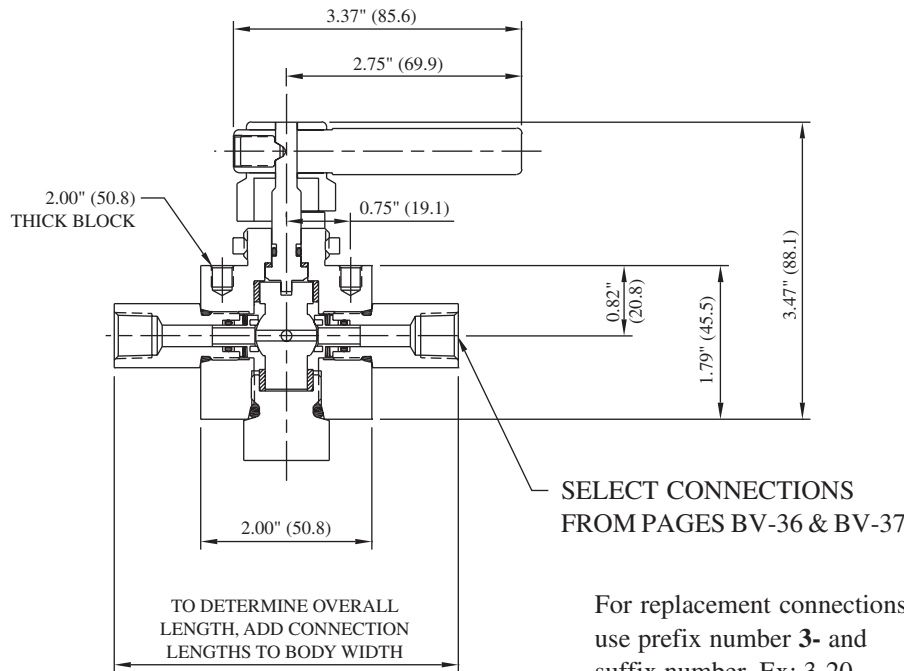

For replacement connections, use prefix number **3-** and suffix number. Ex: 3-20

FEMALE PIPE

Connection	Suffix	Hex	Length	Port	MAWP*
1/8" FNPT	19	0.75" (19.1)	0.60" (15.2)	0.250" (6.4)	15,000 PSI 1030 bar
1/4" FNPT	20	0.75" (19.1)	0.60" (15.2)	0.250" (6.4)	15,000 PSI 1030 bar
3/8" FNPT	21	1.00" (25.4)	1.01" (25.7)	0.250" (6.4)	15,000 PSI 1030 bar
1/2" FNPT	22	1.00" (25.4)	1.01" (25.7)	0.250" (6.4)	15,000 PSI 1030 bar

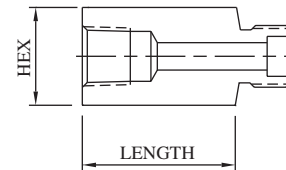

MALE PIPE

Connection	Suffix	Hex	Length	Port	MAWP*
1/8" MNPT	4	0.75" (19.1)	1.01" (25.7)	0.125" (3.2)	15,000 PSI 1030 bar
1/4" MNPT	5	0.75" (19.1)	1.01" (25.7)	0.250" (6.4)	15,000 PSI 1030 bar
3/8" MNPT	6	0.75" (19.1)	1.01" (25.7)	0.250" (6.4)	15,000 PSI 1030 bar
1/2" MNPT	7	1.00" (25.4)	1.26" (32.0)	0.250" (6.4)	15,000 PSI 1030 bar

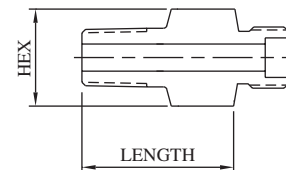

***CAUTION:** The maximum allowable working pressure (MAWP) of the valve shall not exceed the MAWP of the valve series or the selected connection, whichever is less.

All dimensions are for reference only and are subject to change.
 Dimensions in parentheses are millimeters (mm).



10,000 PSI (690 BAR) 4-WAY TRUNNION VALVES

Model No. **4K103**

FEMALE SINGLE-FERRULE TUBE

Connection	Suffix	Hex	Length	Port	MAWP*
1/8" L/P	12	0.75" (19.1)	0.78" (19.8)	0.093" (2.4)	15,000 PSI 1030 bar
1/4" SL/P	13	0.75" (19.1)	1.03" (26.2)	0.125" (3.2)	11,500 PSI 790 bar
3/8" SL/P	14	0.75" (19.1)	1.03" (26.2)	0.250" (6.4)	7,500 PSI 520 bar
1/2" L/P	15	1.00" (25.4)	1.03" (26.2)	0.250" (6.4)	5,500 PSI 380 bar

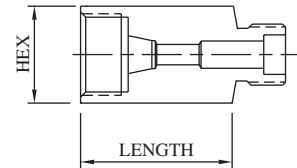

FEMALE M/P CONED AND THREADED TUBE

Connection	Suffix	Hex	Length	Port	MAWP*
1/4" M/P	16	0.75" (19.1)	0.74" (18.8)	0.109" (2.8)	20,000 PSI 1380 bar
3/8" M/P	17	0.75" (19.1)	1.01" (25.7)	0.203" (5.2)	20,000 PSI 1380 bar
9/16" M/P	18	1.00" (25.4)	1.26" (32.0)	0.250" (6.4)	20,000 PSI 1380 bar

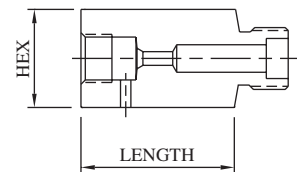

MALE M/P CONED AND THREADED TUBE

Connection	Suffix	Hex	Length	Port	MAWP*
1/4" M/P	8	0.75" (19.1)	1.88" (47.8)	0.109" (2.8)	20,000 PSI 1380 bar
3/8" M/P	10	0.75" (19.1)	2.00" (50.8)	0.203" (5.2)	20,000 PSI 1380 bar
9/16" M/P	11	1.00" (25.4)	2.31" (58.7)	0.250" (6.4)	20,000 PSI 1380 bar

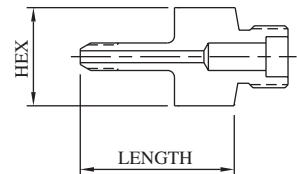

FEMALE H/P CONED AND THREADED TUBE

Connection	Suffix	Hex	Length	Port	MAWP*
1/4" H/P	23	0.75" (19.1)	1.01" (25.7)	0.093" (2.4)	20,000 PSI 1380 bar
3/8" H/P	24	1.00" (25.4)	1.17" (29.7)	0.125" (3.2)	20,000 PSI 1380 bar
9/16" H/P	25	1.37" (34.8)	1.25" (31.8)	0.187" (4.7)	20,000 PSI 1380 bar

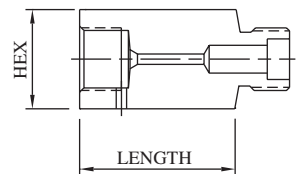

MALE H/P CONED AND THREADED TUBE

Connection	Suffix	Hex	Length	Port	MAWP*
1/4" H/P	9	0.75" (19.1)	1.94" (49.3)	0.083" (2.1)	20,000 PSI 1380 bar
3/8" H/P	30	0.75" (19.1)	2.25" (57.2)	0.125" (3.2)	20,000 PSI 1380 bar
9/16" H/P	42	0.75" (19.1)	2.82" (71.6)	0.187" (4.7)	20,000 PSI 1380 bar

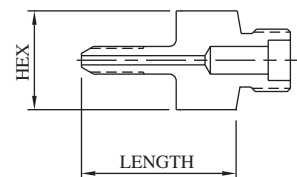

***CAUTION:** The maximum allowable working pressure (MAWP) of the valve shall not exceed the MAWP of the valve series or the selected connection, whichever is less.



All dimensions are for reference only and are subject to change.
Dimensions in parentheses are millimeters (mm).

10,000 PSI (690 BAR) 4-WAY TRUNNION VALVES

Model No. 4K106

*MAWP: 10,000 PSI (690 bar)
 Port: 0.375" (9.5 mm)
 Cv: 2.40

Materials of Construction:

- 316 cold-worked stainless steel body and side adapters
- 17-4PH stem
- PEEK ball seals
- Viton O-rings
- Teflon back-ups

Ordering information and options on page BV-2

Repair Kit P/N RK-4K106 contains stem, trunnion, trunnion seals and seal retainers, o-rings, backups, spring washers, and bearing washers

Mounting:

Panel: 1.28" (32.5 mm) dia
 0.43" (11.0 mm) max thickness
 Side: 0.28" (7.1 mm) dia

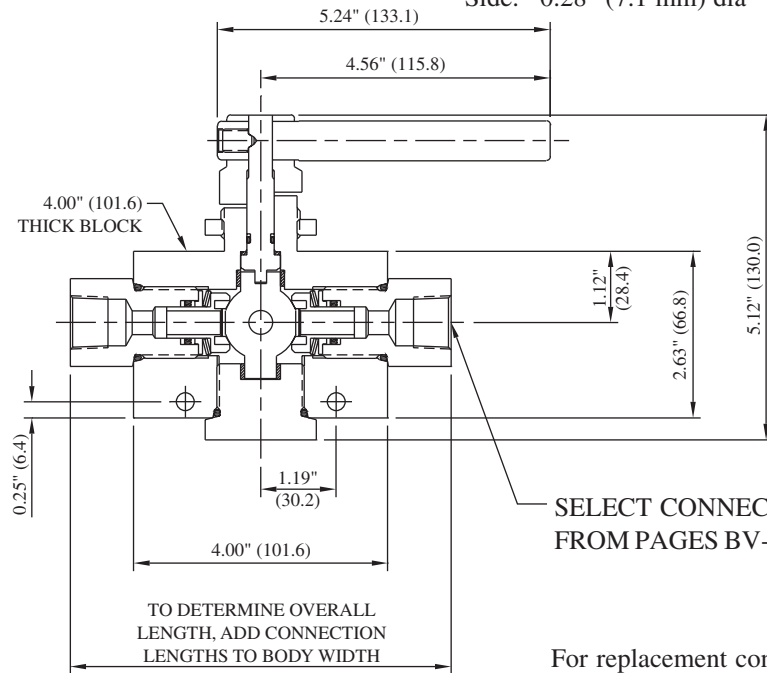

For replacement connections, use prefix number **36-** and suffix number. Ex: 36-20

FEMALE PIPE

Connection	Suffix	Hex	Length	Port	MAWP*
1/8" FNPT	19	1.38" (35.1)	0.47" (11.9)	0.339" (8.6)	15,000 PSI 1030 bar
1/4" FNPT	20	1.38" (35.1)	1.00" (25.4)	0.437" (11.1)	15,000 PSI 1030 bar
3/8" FNPT	21	1.38" (35.1)	1.00" (25.4)	0.500" (12.7)	15,000 PSI 1030 bar
1/2" FNPT	22	1.38" (35.1)	1.00" (25.4)	0.500" (12.7)	15,000 PSI 1030 bar
3/4" FNPT	41	1.38" (35.1)	1.10" (27.9)	0.500" (12.7)	10,000 PSI 690 bar
1" FNPT	45	1.75" (44.5)	1.75" (44.5)	0.500" (12.7)	10,000 PSI 690 bar

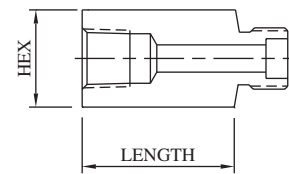

MALE PIPE

Connection	Suffix	Hex	Length	Port	MAWP*
1/8" MNPT	4	1.38" (35.1)	1.08" (27.4)	0.187" (4.7)	15,000 PSI 1030 bar
1/4" MNPT	5	1.38" (35.1)	1.22" (31.0)	0.250" (6.4)	15,000 PSI 1030 bar
3/8" MNPT	6	1.38" (35.1)	1.23" (31.2)	0.375" (9.5)	15,000 PSI 1030 bar
1/2" MNPT	7	1.38" (35.1)	1.59" (40.4)	0.375" (9.5)	15,000 PSI 1030 bar
3/4" MNPT	55	1.38" (35.1)	1.62" (41.1)	0.500" (12.7)	10,000 PSI 690 bar
1" MNPT	56	1.50" (38.1)	1.87" (47.5)	0.500" (12.7)	10,000 PSI 690 bar

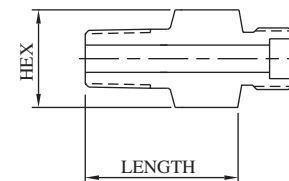

***CAUTION:** The maximum allowable working pressure (MAWP) of the valve shall not exceed the MAWP of the valve series or the selected connection, whichever is less.

All dimensions are for reference only and are subject to change.
 Dimensions in parentheses are millimeters (mm).



10,000 PSI (690 BAR) 4-WAY TRUNNION VALVES

Model No. 4K106

FEMALE SINGLE-FERRULE TUBE

Connection	Suffix	Hex	Length	Port	MAWP*
1/4" SL/P	13	1.38" (35.1)	0.64" (16.3)	0.187" (4.7)	11,500 PSI 790 bar
3/8" SL/P	14	1.38" (35.1)	0.75" (19.1)	0.312" (7.9)	7,500 PSI 520 bar
1/2" L/P	15	1.38" (35.1)	1.06" (26.9)	0.437" (11.1)	5,500 PSI 380 bar

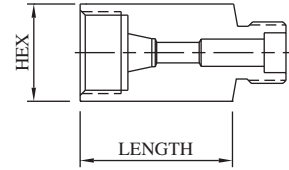

FEMALE M/P CONED AND THREADED TUBE

Connection	Suffix	Hex	Length	Port	MAWP*
1/4" M/P	16	1.38" (35.1)	0.65" (16.5)	0.109" (2.8)	20,000 PSI 1380 bar
3/8" M/P	17	1.38" (35.1)	1.06" (26.9)	0.203" (5.2)	20,000 PSI 1380 bar
9/16" M/P	18	1.38" (35.1)	1.31" (33.3)	0.312" (7.9)	20,000 PSI 1380 bar
3/4" M/P	32	1.38" (35.1)	1.52" (38.6)	0.437" (11.1)	20,000 PSI 1380 bar
1" M/P	43	1.75" (44.5)	1.91" (48.5)	0.500" (12.7)	20,000 PSI 1380 bar

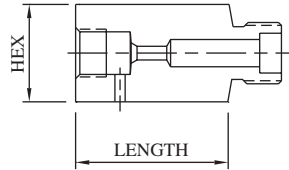

MALE M/P CONED AND THREADED TUBE

Connection	Suffix	Hex	Length	Port	MAWP*
1/4" M/P	8	1.38" (35.1)	1.91" (48.5)	0.109" (2.8)	20,000 PSI 1380 bar
3/8" M/P	10	1.38" (35.1)	1.87" (47.5)	0.203" (5.2)	20,000 PSI 1380 bar
9/16" M/P	11	1.38" (35.1)	3.21" (81.5)	0.312" (7.9)	20,000 PSI 1380 bar
3/4" M/P	37	1.38" (35.1)	3.54" (89.9)	0.437" (11.1)	20,000 PSI 1380 bar
1" M/P	49	1.38" (35.1)	3.20" (81.3)	0.500" (12.7)	20,000 PSI 1380 bar

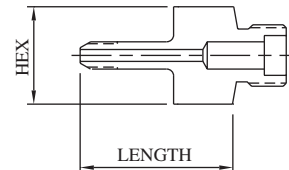

FEMALE H/P CONED AND THREADED TUBE

Connection	Suffix	Hex	Length	Port	MAWP*
1/4" H/P	23	1.38" (35.1)	0.58" (14.7)	0.093" (2.4)	20,000 PSI 1380 bar
3/8" H/P	24	1.38" (35.1)	0.89" (22.6)	0.125" (3.2)	20,000 PSI 1380 bar
9/16" H/P	25	1.50" (38.1)	0.98" (24.9)	0.187" (4.7)	20,000 PSI 1380 bar

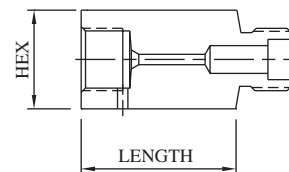

MALE H/P CONED AND THREADED TUBE

Connection	Suffix	Hex	Length	Port	MAWP*
1/4" H/P	9	1.38" (35.1)	2.16" (54.9)	0.083" (2.1)	20,000 PSI 1380 bar
3/8" H/P	30	1.38" (35.1)	2.40" (61.0)	0.125" (3.2)	20,000 PSI 1380 bar
9/16" H/P	42	1.38" (35.1)	2.89" (73.4)	0.187" (4.7)	20,000 PSI 1380 bar

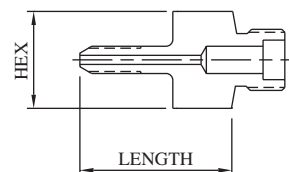

***CAUTION:** The maximum allowable working pressure (MAWP) of the valve shall not exceed the MAWP of the valve series or the selected connection, whichever is less.



All dimensions are for reference only and are subject to change.
Dimensions in parentheses are millimeters (mm).

10,000 PSI (690 BAR) 5-WAY TRUNNION VALVES

Model No. 5K103

*MAWP: 10,000 PSI (690 bar)
 Port: 0.187" (4.7 mm)
 Cv: 0.56

Materials of Construction:

- 316 cold-worked stainless steel body and side adapters
- 17-4PH stem
- PEEK ball seals
- Viton O-rings
- Teflon back-ups

Ordering information and options on page BV-2

Repair Kit P/N RK-5K103 contains stem, trunnion, trunnion seals and seal retainers, o-rings, backups, spring washers, and bearing washers

Mounting:

Panel: 1.06" (26.9 mm) dia
 0.25" (6.4 mm) max thickness
 Top: 1/4"-20 UNC

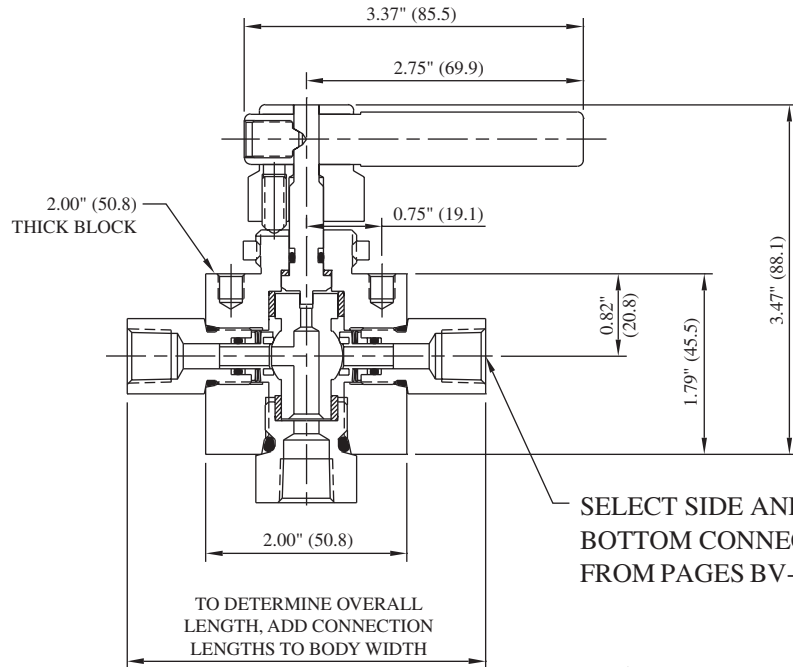

For replacement connections, use prefix number **3-** and suffix number. Ex: 3-20

FEMALE PIPE

Connection	For Side Connections				For Bottom Connection				MAWP*
	Suffix	Hex	Length	Port	Suffix	Hex	Length	Port	
1/8" FNPT	19	0.75" (19.1)	0.60" (15.2)	0.250" (6.4)	19B	1.00" (25.4)	0.63" (16.0)	0.250" (6.4)	15,000 PSI 1030 bar
1/4" FNPT	20	0.75" (19.1)	0.60" (15.2)	0.250" (6.4)	20B	1.00" (25.4)	0.55" (14.0)	0.250" (6.4)	15,000 PSI 1030 bar
3/8" FNPT	21	1.00" (25.4)	1.01" (25.7)	0.250" (6.4)	21B	1.00" (25.4)	1.01" (25.7)	0.250" (6.4)	15,000 PSI 1030 bar
1/2" FNPT	22	1.00" (25.4)	1.01" (25.7)	0.250" (6.4)	22B	1.00" (25.4)	1.16" (29.5)	0.250" (6.4)	15,000 PSI 1030 bar

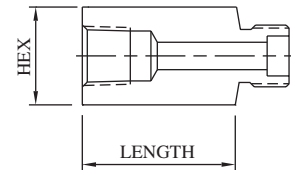

MALE PIPE

Connection	For Side Connections				For Bottom Connection				MAWP*
	Suffix	Hex	Length	Port	Suffix	Hex	Length	Port	
1/8" MNPT	4	0.75" (19.1)	1.01" (25.7)	0.125" (3.2)	4B	1.00" (25.4)	0.93" (23.6)	0.125" (3.2)	15,000 PSI 1030 bar
1/4" MNPT	5	0.75" (19.1)	1.01" (25.7)	0.250" (6.4)	5B	1.00" (25.4)	1.05" (26.7)	0.250" (6.4)	15,000 PSI 1030 bar
3/8" MNPT	6	0.75" (19.1)	1.01" (25.7)	0.250" (6.4)	6B	1.00" (25.4)	1.01" (25.7)	0.250" (6.4)	15,000 PSI 1030 bar
1/2" MNPT	7	1.00" (25.4)	1.26" (32.0)	0.250" (6.4)	7B	1.00" (25.4)	1.29" (32.8)	0.250" (6.4)	15,000 PSI 1030 bar

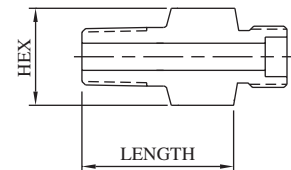

***CAUTION:** The maximum allowable working pressure (MAWP) of the valve shall not exceed the MAWP of the valve series or the selected connection, whichever is less.

All dimensions are for reference only and are subject to change.
 Dimensions in parentheses are millimeters (mm).



10,000 PSI (690 BAR) 5-WAY TRUNNION VALVES

Model No. **5K103**

FEMALE SINGLE-FERRULE TUBE

Connection	For Side Connections				For Bottom Connection				MAWP*
	Suffix	Hex	Length	Port	Suffix	Hex	Length	Port	
1/8" L/P	12	0.75" (19.1)	0.78" (19.8)	0.093" (2.4)	12B	1.00" (25.4)	0.55" (14.0)	0.093" (2.4)	15,000 PSI 1030 bar
1/4" SL/P	13	0.75" (19.1)	1.03" (26.2)	0.125" (3.2)	13B	1.00" (25.4)	0.83" (21.0)	0.125" (3.2)	11,500 PSI 790 bar
3/8" SL/P	14	0.75" (19.1)	1.03" (26.2)	0.250" (6.4)	14B	1.00" (25.4)	1.01" (25.7)	0.250" (6.4)	7,500 PSI 520 bar
1/2" L/P	15	1.00" (25.4)	1.03" (26.2)	0.250" (6.4)	15B	1.00" (25.4)	1.01" (25.7)	0.250" (6.4)	5,500 PSI 380 bar

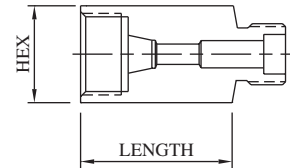

FEMALE M/P CONED AND THREADED TUBE

Connection	For Side Connections				For Bottom Connection				MAWP*
	Suffix	Hex	Length	Port	Suffix	Hex	Length	Port	
1/4" M/P	16	0.75" (19.1)	0.74" (18.8)	0.109" (2.8)	16B	1.00" (25.4)	0.76" (19.3)	0.109" (2.8)	20,000 PSI 1380 bar
3/8" M/P	17	0.75" (19.1)	1.01" (25.7)	0.203" (5.2)	17B	1.00" (25.4)	0.83" (21.0)	0.203" (5.2)	20,000 PSI 1380 bar
9/16" M/P	18	1.00" (25.4)	1.26" (32.0)	0.250" (6.4)	18B	1.00" (25.4)	1.01" (25.7)	0.312" (7.9)	20,000 PSI 1380 bar

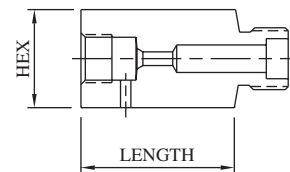

MALE M/P CONED AND THREADED TUBE

Connection	For Side Connections				For Bottom Connection				MAWP*
	Suffix	Hex	Length	Port	Suffix	Hex	Length	Port	
1/4" M/P	8	0.75" (19.1)	1.88" (47.8)	0.109" (2.8)	8B	1.00" (25.4)	1.88" (47.8)	0.109" (2.8)	20,000 PSI 1380 bar
3/8" M/P	10	0.75" (19.1)	2.00" (50.8)	0.203" (5.2)	10B	1.00" (25.4)	2.00" (50.8)	0.203" (5.2)	20,000 PSI 1380 bar
9/16" M/P	11	1.00" (25.4)	2.31" (58.7)	0.250" (6.4)	11B	1.12" (28.4)	2.95" (74.9)	0.312" (7.9)	20,000 PSI 1380 bar

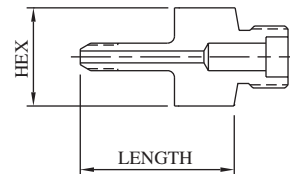

FEMALE H/P CONED AND THREADED TUBE

Connection	For Side Connections				For Bottom Connection				MAWP*
	Suffix	Hex	Length	Port	Suffix	Hex	Length	Port	
1/4" H/P	23	0.75" (19.1)	1.01" (25.7)	0.093" (2.4)	23B	1.00" (25.4)	0.89" (22.6)	0.093" (2.4)	20,000 PSI 1380 bar
3/8" H/P	24	1.00" (25.4)	1.17" (29.7)	0.125" (3.2)	24B	1.00" (25.4)	0.99" (25.1)	0.125" (3.2)	20,000 PSI 1380 bar
9/16" H/P	25	1.37" (34.8)	1.25" (31.8)	0.187" (4.7)	25B	1.37" (34.8)	1.25" (31.8)	0.187" (4.7)	20,000 PSI 1380 bar

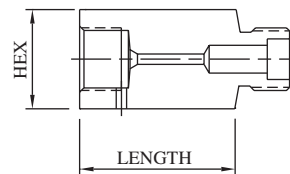

MALE H/P CONED AND THREADED TUBE

Connection	For Side Connections				For Bottom Connection				MAWP*
	Suffix	Hex	Length	Port	Suffix	Hex	Length	Port	
1/4" H/P	9	0.75" (19.1)	1.94" (49.3)	0.083" (2.1)	9B	1.00" (25.4)	2.12" (53.8)	0.083" (2.1)	20,000 PSI 1380 bar
3/8" H/P	30	0.75" (19.1)	2.25" (57.2)	0.125" (3.2)	30B	1.00" (25.4)	2.35" (59.7)	0.125" (3.2)	20,000 PSI 1380 bar
9/16" H/P	42	0.75" (19.1)	2.82" (71.6)	0.187" (4.7)	42B	1.00" (25.4)	2.88" (73.2)	0.187" (4.7)	20,000 PSI 1380 bar

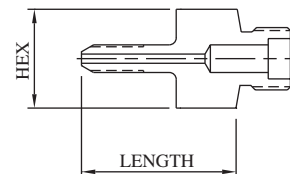

***CAUTION:** The maximum allowable working pressure (MAWP) of the valve shall not exceed the MAWP of the valve series or the selected connection, whichever is less.



All dimensions are for reference only and are subject to change.
Dimensions in parentheses are millimeters (mm).

10,000 PSI (690 BAR) 5-WAY TRUNNION VALVES

Model No. 5K106

*MAWP: 10,000 PSI (690 bar)
 Port: 0.375" (9.5 mm)
 Cv: 2.40

Materials of Construction:

- 316 cold-worked stainless steel body and side adapters
- 17-4PH stem
- PEEK ball seals
- Viton O-rings
- Teflon back-ups

Ordering information and options on page BV-2

Repair Kit P/N RK-5K106 contains stem, trunnion, trunnion seals and seal retainers, o-rings, backups, spring washers, and bearing washers

Mounting:

Panel: 1.28" (32.5 mm) dia
 0.43" (11.0 mm) max thickness
 Side: 0.28" (7.1 mm) dia

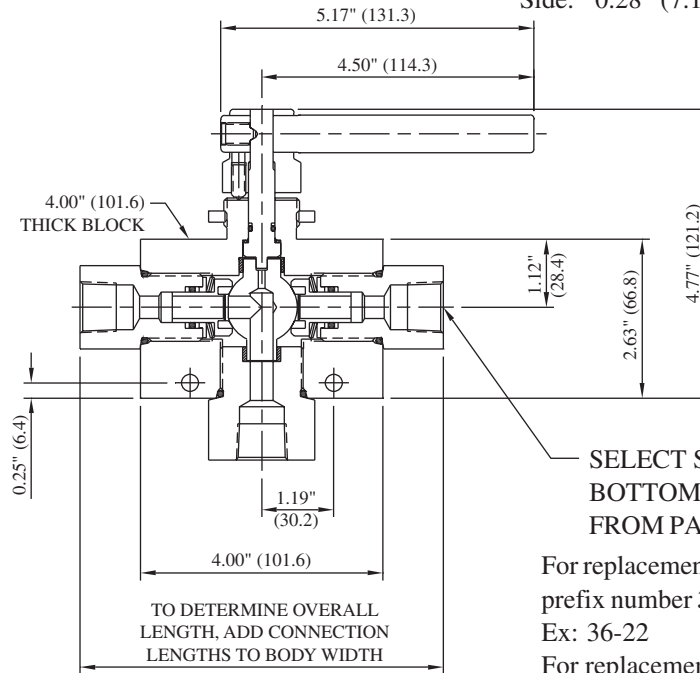

SELECT SIDE AND BOTTOM CONNECTIONS FROM PAGES BV-42 & BV-43

For replacement side connections, use prefix number **36-** and suffix number. Ex: 36-22

For replacement bottom connections, use prefix number **46-** and suffix number. Ex: 46-22B

FEMALE PIPE

Connection	For Side Connections				For Bottom Connection				MAWP*
	Suffix	Hex	Length	Port	Suffix	Hex	Length	Port	
1/8" FNPT	19	1.38" (35.1)	0.47" (11.9)	0.339" (8.6)	19B	1.75" (44.5)	0.47" (11.9)	0.339" (8.6)	15,000 PSI 1030 bar
1/4" FNPT	20	1.38" (35.1)	1.00" (25.4)	0.437" (11.1)	20B	1.75" (44.5)	0.37" (9.4)	0.375" (9.5)	15,000 PSI 1030 bar
3/8" FNPT	21	1.38" (35.1)	1.00" (25.4)	0.500" (12.7)	21B	1.75" (44.5)	1.06" (26.9)	0.375" (9.5)	15,000 PSI 1030 bar
1/2" FNPT	22	1.38" (35.1)	1.00" (25.4)	0.500" (12.7)	22B	1.75" (44.5)	1.11" (28.2)	0.375" (9.5)	15,000 PSI 1030 bar
3/4" FNPT	41	1.38" (35.1)	1.10" (27.9)	0.500" (12.7)	41B	1.75" (44.5)	1.17" (29.7)	0.375" (9.5)	10,000 PSI 690 bar
1" FNPT	45	1.75" (44.5)	1.75" (44.5)	0.500" (12.7)	45B	1.75" (44.5)	1.75" (44.5)	0.500" (12.7)	10,000 PSI 690 bar

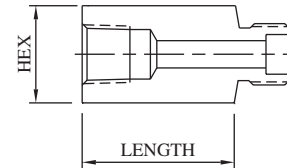

MALE PIPE

Connection	For Side Connections				For Bottom Connection				MAWP*
	Suffix	Hex	Length	Port	Suffix	Hex	Length	Port	
1/8" MNPT	4	1.38" (35.1)	1.08" (27.4)	0.187" (4.7)	4B	1.75" (44.5)	1.09" (27.7)	0.187" (4.7)	15,000 PSI 1030 bar
1/4" MNPT	5	1.38" (35.1)	1.22" (31.0)	0.250" (6.4)	5B	1.75" (44.5)	1.31" (33.3)	0.250" (6.4)	15,000 PSI 1030 bar
3/8" MNPT	6	1.38" (35.1)	1.23" (31.2)	0.375" (9.5)	6B	1.75" (44.5)	1.43" (36.3)	0.375" (9.5)	15,000 PSI 1030 bar
1/2" MNPT	7	1.38" (35.1)	1.59" (40.4)	0.375" (9.5)	7B	1.75" (44.5)	1.63" (41.4)	0.375" (9.5)	15,000 PSI 1030 bar
3/4" MNPT	55	1.38" (35.1)	1.62" (41.1)	0.500" (12.7)	55B	1.75" (44.5)	1.65" (41.9)	0.375" (9.5)	10,000 PSI 690 bar
1" MNPT	56	1.50" (38.1)	1.87" (47.5)	0.500" (12.7)	56B	1.75" (44.5)	1.90" (48.3)	0.375" (9.5)	10,000 PSI 690 bar

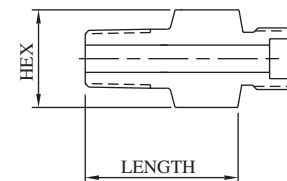

***CAUTION:** The maximum allowable working pressure (MAWP) of the valve shall not exceed the MAWP of the valve series or the selected connection, whichever is less.

All dimensions are for reference only and are subject to change.
 Dimensions in parentheses are millimeters (mm).



10,000 PSI (690 BAR) 5-WAY TRUNNION VALVES

Model No. **5K106**

FEMALE SINGLE-FERRULE TUBE

Connection	For Side Connections				For Bottom Connection				MAWP*
	Suffix	Hex	Length	Port	Suffix	Hex	Length	Port	
1/4" SL/P	13	1.38" (35.1)	0.64" (16.3)	0.187" (4.7)	13B	1.75" (44.5)	0.66" (16.8)	0.187" (4.7)	11,500 PSI 790 bar
3/8" SL/P	14	1.38" (35.1)	0.75" (19.1)	0.312" (7.9)	14B	1.75" (44.5)	0.75" (19.1)	0.312" (7.9)	7,500 PSI 520 bar
1/2" L/P	15	1.38" (35.1)	1.06" (26.9)	0.437" (11.1)	15B	1.75" (44.5)	1.06" (26.9)	0.375" (9.5)	5,500 PSI 380 bar

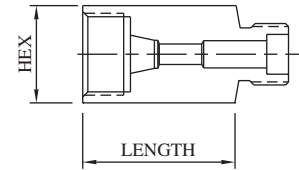

FEMALE M/P CONED AND THREADED TUBE

Connection	For Side Connections				For Bottom Connection				MAWP*
	Suffix	Hex	Length	Port	Suffix	Hex	Length	Port	
1/4" M/P	16	1.38" (35.1)	0.65" (16.5)	0.109" (2.8)	16B	1.75" (44.5)	1.11" (28.2)	0.109" (2.8)	20,000 PSI 1380 bar
3/8" M/P	17	1.38" (35.1)	1.06" (26.9)	0.203" (5.2)	17B	1.75" (44.5)	1.06" (26.9)	0.203" (5.2)	20,000 PSI 1380 bar
9/16" M/P	18	1.38" (35.1)	1.31" (33.3)	0.312" (7.9)	18B	1.75" (44.5)	1.06" (26.9)	0.312" (7.9)	20,000 PSI 1380 bar
3/4" M/P	32	1.38" (35.1)	1.52" (38.6)	0.437" (11.1)	32B	1.75" (44.5)	1.18" (30.0)	0.375" (9.5)	20,000 PSI 1380 bar
1" M/P	43	1.75" (44.5)	1.91" (48.5)	0.500" (12.7)	43B	1.75" (44.5)	1.99" (50.5)	0.375" (9.5)	20,000 PSI 1380 bar

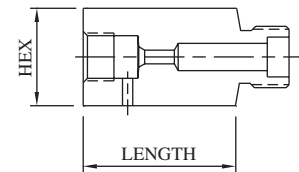

MALE M/P CONED AND THREADED TUBE

Connection	For Side Connections				For Bottom Connection				MAWP*
	Suffix	Hex	Length	Port	Suffix	Hex	Length	Port	
1/4" M/P	8	1.38" (35.1)	1.91" (48.5)	0.109" (2.8)	8B	1.75" (44.5)	1.93" (49.0)	0.109" (2.8)	20,000 PSI 1380 bar
3/8" M/P	10	1.38" (35.1)	1.87" (47.5)	0.203" (5.2)	10B	1.75" (44.5)	2.17" (55.1)	0.203" (5.2)	20,000 PSI 1380 bar
9/16" M/P	11	1.38" (35.1)	3.21" (81.5)	0.312" (7.9)	11B	1.75" (44.5)	2.18" (55.4)	0.312" (7.9)	20,000 PSI 1380 bar
3/4" M/P	37	1.38" (35.1)	3.54" (89.9)	0.437" (11.1)	37B	1.75" (44.5)	5.06" (128.5)	0.437" (11.1)	20,000 PSI 1380 bar
1" M/P	49	1.38" (35.1)	3.20" (81.3)	0.500" (12.7)	49B	1.75" (44.5)	3.25" (82.6)	0.500" (12.7)	20,000 PSI 1380 bar

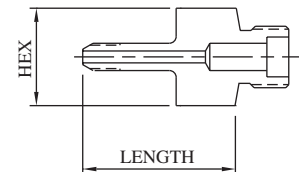

FEMALE H/P CONED AND THREADED TUBE

Connection	For Side Connections				For Bottom Connection				MAWP*
	Suffix	Hex	Length	Port	Suffix	Hex	Length	Port	
1/4" H/P	23	1.38" (35.1)	0.58" (14.7)	0.093" (2.4)	23B	1.75" (44.5)	0.60" (15.2)	0.093" (2.4)	20,000 PSI 1380 bar
3/8" H/P	24	1.38" (35.1)	0.89" (22.6)	0.125" (3.2)	24B	1.75" (44.5)	0.91" (23.1)	0.125" (3.2)	20,000 PSI 1380 bar
9/16" H/P	25	1.50" (38.1)	0.98" (24.9)	0.187" (4.7)	25B	1.75" (44.5)	1.02" (25.9)	0.187" (4.7)	20,000 PSI 1380 bar

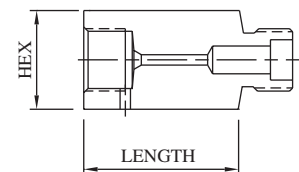

MALE H/P CONED AND THREADED TUBE

Connection	For Side Connections				For Bottom Connection				MAWP*
	Suffix	Hex	Length	Port	Suffix	Hex	Length	Port	
1/4" H/P	9	1.38" (35.1)	2.16" (54.9)	0.083" (2.1)	9B	1.75" (44.5)	2.19" (55.6)	0.083" (2.1)	20,000 PSI 1380 bar
3/8" H/P	30	1.38" (35.1)	2.40" (61.0)	0.125" (3.2)	30B	1.75" (44.5)	2.42" (61.5)	0.125" (3.2)	20,000 PSI 1380 bar
9/16" H/P	42	1.38" (35.1)	2.89" (73.4)	0.187" (4.7)	42B	1.75" (44.5)	2.92" (74.2)	0.187" (4.7)	20,000 PSI 1380 bar

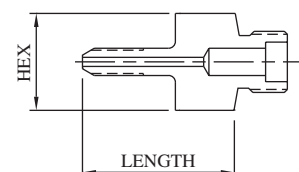

***CAUTION:** The maximum allowable working pressure (MAWP) of the valve shall not exceed the MAWP of the valve series or the selected connection, whichever is less.



All dimensions are for reference only and are subject to change.
Dimensions in parentheses are millimeters (mm).

ACTUATORS

All BuTech ball valves can be fitted with pneumatic or electric actuators for remote control. The following pages show dimensional and technical data for our most popular actuators. Other models are available for unique applications. Please call our sales department for more information.

Available options for actuated valves include:

Visual Monitor

Valve position can be monitored from distances up to 150 ft (45 m)
Specify option **-LB**

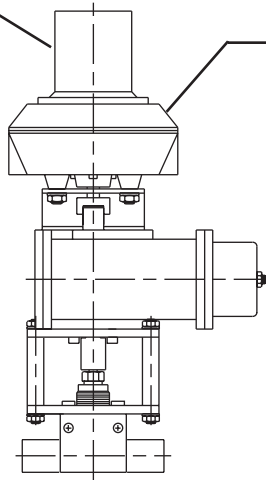

Limit Switches or Solenoid Valves

Two limit switches or solenoid pilot valves can be used for signalling lights, motors, micro-processors or hydraulic valves

Specify option **-L** for limit switches
Specify option **-S** for solenoid valves

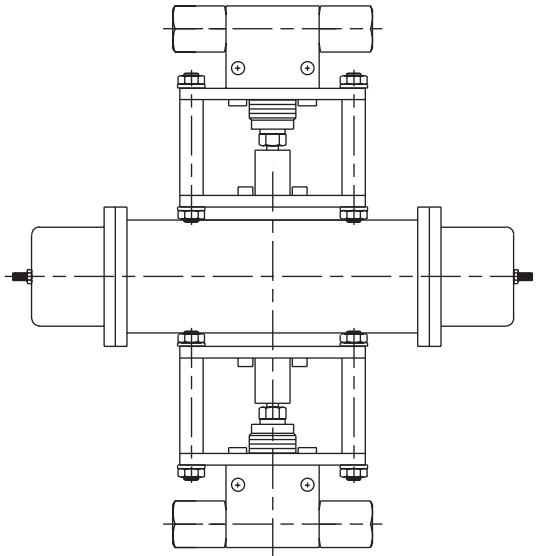

2 Valves / 1 Actuator

BuTech valves can be paired on a single actuator for simultaneous actuation. To order, determine catalog number for ordering a single valve, complete with connection numbers, options and actuator information (see page BV-2), then add the prefix “2”

Example

To specify two K104 valves with 1/4" FNPT connections mounted on a double-acting actuator, the catalog number would be **2K104-20-20-RC10DA**

DOUBLE-ACTING ALUMINUM HOUSING PNEUMATIC ACTUATORS

For valve models beginning **K** or **3DVK**

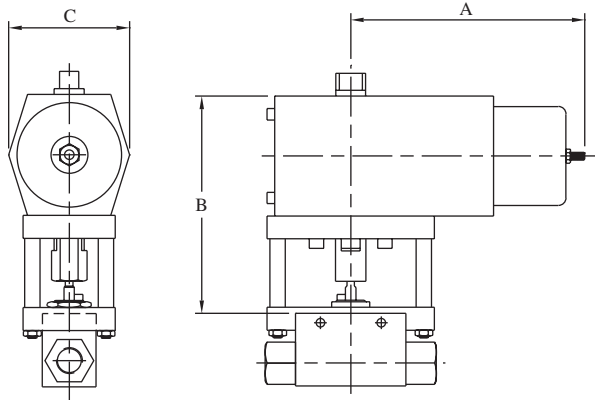

Figure 1

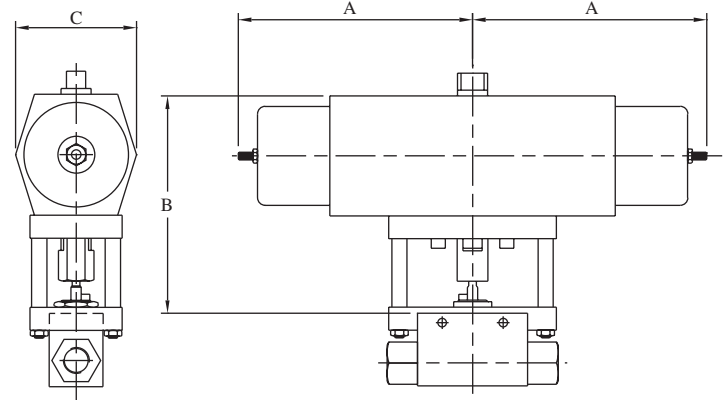

Figure 2

Maximum Air Pressure: 150 PSI (10 bar)

Operating Temperature Range: -20 to 175° F (-29 to 79° C)

Valve Model	Actuator Model	Dimensional Data				Air Consumption per Stroke (Free Air)		Required Air Pressure	Opening/Closing Time
		A	B	C	Fig.	Open	Close		
K34	RA05DA	2.20" (55.9)	5.53" (140.5)	2.60" (66.0)	1	51.0 cu in 836 cc	51.0 cu in 836 cc	80 PSI 5.5 bar	1 sec
K63	RA05DA	2.20" (55.9)	5.53" (140.5)	2.60" (66.0)	1	51.0 cu in 836 cc	51.0 cu in 836 cc	80 PSI 5.5 bar	1 sec
K103	RA05DA	2.20" (55.9)	5.53" (140.5)	2.60" (66.0)	1	51.0 cu in 836 cc	51.0 cu in 836 cc	80 PSI 5.5 bar	1 sec
K104	RA05DA	2.20" (55.9)	6.08" (154.4)	2.60" (66.0)	1	51.0 cu in 836 cc	51.0 cu in 836 cc	80 PSI 5.5 bar	1 sec
K106	RA05DA	2.20" (55.9)	6.08" (154.4)	2.60" (66.0)	1	51.0 cu in 836 cc	51.0 cu in 836 cc	80 PSI 5.5 bar	1 sec
K108	RC20DA	3.85" (97.8)	5.20" (132.1)	3.00" (76.2)	2	64.0 cu in 1049 cc	73.0 cu in 1196 cc	80 PSI 5.5 bar	1 sec
K204	RA05DA	2.20" (55.9)	6.08" (154.4)	2.60" (66.0)	1	51.0 cu in 836 cc	51.0 cu in 836 cc	80 PSI 5.5 bar	1 sec
K206	RA05DA	2.20" (55.9)	6.08" (154.4)	2.60" (66.0)	1	51.0 cu in 836 cc	51.0 cu in 836 cc	80 PSI 5.5 bar	1 sec
3DVK34	RA05DA	2.20" (55.9)	5.60" (142.2)	2.60" (66.0)	1	51.0 cu in 836 cc	51.0 cu in 836 cc	80 PSI 5.5 bar	1 sec
3DVK63	RA05DA	2.20" (55.9)	5.60" (142.2)	2.60" (66.0)	1	51.0 cu in 836 cc	51.0 cu in 836 cc	80 PSI 5.5 bar	1 sec
3DVK93	RA05DA	2.20" (55.9)	5.60" (142.2)	2.60" (66.0)	1	51.0 cu in 836 cc	51.0 cu in 836 cc	80 PSI 5.5 bar	1 sec
3DVK106	RC20DA	3.85" (97.8)	5.20" (132.1)	3.00" (76.2)	2	64.0 cu in 1049 cc	73.0 cu in 1196 cc	80 PSI 5.5 bar	1 sec
3DVK108	RC30DA	5.30" (134.6)	7.00" (177.8)	4.10" (104.1)	1	122.0 cu in 1999 cc	266.0 cu in 4359 cc	80 PSI 5.5 bar	1.5-2.0 sec
3DVK123	RA05DA	2.20" (55.9)	5.78" (146.8)	2.60" (66.0)	1	51.0 cu in 836 cc	51.0 cu in 836 cc	80 PSI 5.5 bar	1 sec
3DVK203	RC10DA	3.85" (97.8)	5.51" (140.0)	2.87" (72.9)	1	32.0 cu in 524 cc	61.0 cu in 1000 cc	80 PSI 5.5 bar	1 sec
3DVK206	RC30DA	5.30" (134.6)	6.82" (173.2)	4.10" (104.1)	1	122.0 cu in 1999 cc	226.0 cu in 3703 cc	80 PSI 5.5 bar	1.5-2.0 sec

All dimensions are for reference only and are subject to change.
Dimensions in parentheses are millimeters (mm).

SPRING-RETURN ALUMINUM HOUSING PNEUMATIC ACTUATORS

For valve models beginning **K** or **3DVK**

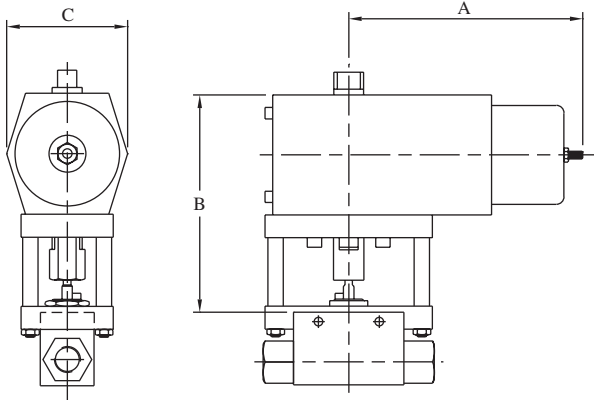

Figure 1

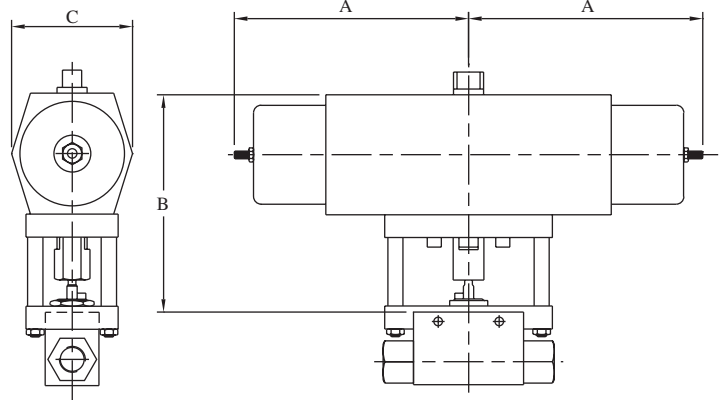

Figure 2

Maximum Air Pressure: 150 PSI (10 bar)

Operating Temperature Range: -20 to 175° F (-29 to 79° C)

Valve Model	Actuator Model	Dimensional Data				Air Consumption per Stroke (Free Air)	Required Air Pressure	Opening/Closing Time
		A	B	C	Fig.			
K34	RA05SR	4.65" (118.1)	5.53" (140.5)	2.60" (66.0)	1	51.0 cu in 836 cc	80 PSI 5.5 bar	1 sec
K63	RA05SR	4.65" (118.1)	5.53" (140.5)	2.60" (66.0)	1	51.0 cu in 836 cc	80 PSI 5.5 bar	1 sec
K103	RA05SR	4.65" (118.1)	5.53" (140.5)	2.60" (66.0)	1	51.0 cu in 836 cc	80 PSI 5.5 bar	1 sec
K104	RC10SR	5.70" (144.8)	6.08" (154.4)	2.60" (66.0)	1	51.0 cu in 836 cc	80 PSI 5.5 bar	1 sec
K106	RC10SR	5.70" (144.8)	6.08" (154.4)	2.60" (66.0)	1	51.0 cu in 836 cc	80 PSI 5.5 bar	1 sec
K108	RC30SR	7.70" (195.6)	7.00" (177.8)	4.10" (104.1)	2	122.0 cu in 1999 cc	80 PSI 5.5 bar	1.5-2.0 sec
K204	RC10SR	5.70" (144.8)	7.00" (177.8)	4.10" (104.1)	1	51.0 cu in 836 cc	80 PSI 5.5 bar	1 sec
K206	RC10SR	5.70" (144.8)	6.08" (154.4)	2.60" (66.0)	1	51.0 cu in 836 cc	80 PSI 5.5 bar	1 sec
3DVK34	RA05SR	4.65" (118.1)	5.60" (142.2)	2.60" (66.0)	1	51.0 cu in 836 cc	80 PSI 5.5 bar	1 sec
3DVK63	RA05SR	4.65" (118.1)	5.60" (142.2)	2.60" (66.0)	1	51.0 cu in 836 cc	80 PSI 5.5 bar	1 sec
3DVK93	RC10SR	4.65" (118.1)	5.60" (142.2)	2.60" (66.0)	1	51.0 cu in 836 cc	80 PSI 5.5 bar	1 sec
3DVK106	RC30SR	7.70" (195.6)	7.07" (179.6)	4.10" (104.1)	1	122.0 cu in 1999 cc	80 PSI 5.5 bar	1.5-2.0 sec
3DVK108	RC40SR	7.70" (195.6)	6.47" (164.3)	4.10" (104.1)	2	244.0 cu in 3998 cc	80 PSI 5.5 bar	1.5-2.0 sec
3DVK123	RC10SR	5.70" (144.8)	5.78" (146.8)	2.60" (66.0)	1	32.0 cu in 524 cc	80 PSI 5.5 bar	1 sec
3DVK203	RC20SR	5.70" (144.8)	5.51" (140.0)	2.87" (72.9)	2	64.0 cu in 1049 cc	80 PSI 5.5 bar	1 sec
3DVK206	RC30SR	7.70" (195.6)	7.00" (177.8)	4.10" (104.1)	1	122.0 cu in 1999 cc	80 PSI 5.5 bar	1.5-2.0 sec

All dimensions are for reference only and are subject to change.
Dimensions in parentheses are millimeters (mm).

DOUBLE-ACTING STAINLESS STEEL HOUSING PNEUMATIC ACTUATORS

For valve models beginning **K** or **3DVK**

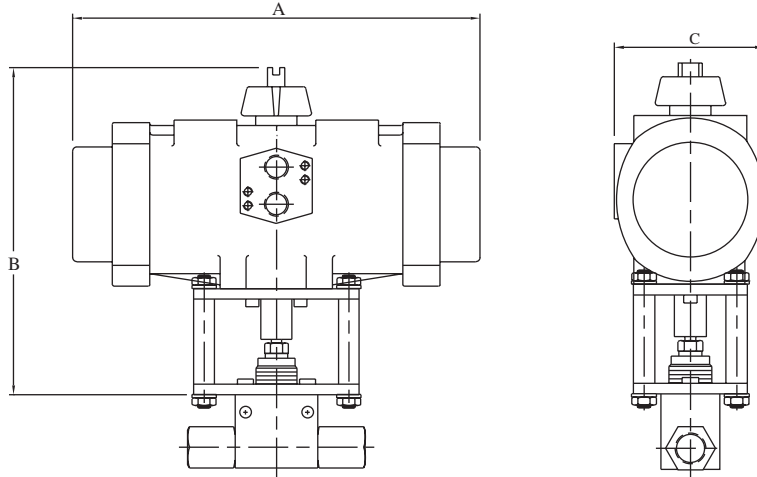

Operating Temperature Range: -20 to 175° F (-29 to 79° C)

Valve Model	Actuator Model	Dimensional Data			Air Consumption per Stroke (Free Air)		Required Air Pressure	Opening/Closing Time
		A	B	C	Open	Close		
K34	RA10DASS	4.19" (106.4)	6.85" (174.0)	3.15" (80.0)	9.0 cu in 147 cc	7.5 cu in 123 cc	15 PSI 1.0 bar	0.15 sec
K63	RA10DASS	4.19" (106.4)	6.85" (174.0)	3.15" (80.0)	9.0 cu in 147 cc	7.5 cu in 123 cc	15 PSI 1.0 bar	0.15 sec
K103	RA10DASS	4.19" (106.4)	6.85" (174.0)	3.15" (80.0)	9.0 cu in 147 cc	7.5 cu in 123 cc	20 PSI 1.4 bar	0.15 sec
K104	RA10DASS	4.19" (106.4)	6.98" (177.3)	3.15" (80.0)	9.0 cu in 147 cc	7.5 cu in 123 cc	20 PSI 1.4 bar	0.15 sec
K106	RA10DASS	4.19" (106.4)	6.98" (177.3)	3.15" (80.0)	9.0 cu in 147 cc	7.5 cu in 123 cc	30 PSI 2.1 bar	0.15 sec
K108	RA20DASS	7.00" (177.8)	7.23" (183.6)	3.82" (97.0)	19.5 cu in 320 cc	17.0 cu in 279 cc	50 PSI 3.4 bar	0.35 sec
K204	RA10DASS	4.19" (106.4)	6.98" (177.3)	3.15" (80.0)	9.0 cu in 147 cc	7.5 cu in 123 cc	30 PSI 2.1 bar	0.15 sec
K206	RA10DASS	4.19" (106.4)	6.98" (177.3)	3.15" (80.0)	9.0 cu in 147 cc	7.5 cu in 123 cc	40 PSI 2.8 bar	0.15 sec
3DVK34	RA10DASS	4.19" (106.4)	6.85" (174.0)	3.15" (80.0)	9.0 cu in 147 cc	7.5 cu in 123 cc	20 PSI 1.4 bar	0.15 sec
3DVK63	RA10DASS	4.19" (106.4)	6.85" (174.0)	3.15" (80.0)	9.0 cu in 147 cc	7.5 cu in 123 cc	20 PSI 1.4 bar	0.15 sec
3DVK93	RA10DASS	4.19" (106.4)	6.85" (174.0)	3.15" (80.0)	9.0 cu in 147 cc	7.5 cu in 123 cc	20 PSI 1.4 bar	0.15 sec
3DVK106	RA20DASS	7.00" (177.8)	7.58" (192.5)	3.82" (97.0)	19.5 cu in 320 cc	17.0 cu in 279 cc	40 PSI 2.8 bar	0.35 sec
3DVK108	RA20DASS	7.00" (177.8)	7.75" (196.9)	3.82" (97.0)	19.5 cu in 320 cc	17.0 cu in 279 cc	60 PSI 4.1 bar	0.35 sec
3DVK123	RA10DASS	4.19" (106.4)	6.98" (177.3)	3.15" (80.0)	9.0 cu in 147 cc	7.5 cu in 123 cc	30 PSI 2.1 bar	0.15 sec
3DVK203	RA10DASS	4.19" (106.4)	6.98" (177.3)	3.15" (80.0)	9.0 cu in 147 cc	7.5 cu in 123 cc	50 PSI 3.4 bar	0.15 sec
3DVK206	RA20DASS	7.00" (177.8)	7.58" (192.5)	3.82" (97.0)	19.5 cu in 320 cc	17.0 cu in 279 cc	50 PSI 3.4 bar	0.35 sec

All dimensions are for reference only and are subject to change.
Dimensions in parentheses are millimeters (mm).



SPRING-RETURN STAINLESS STEEL HOUSING PNEUMATIC ACTUATORS

For valve models beginning **K** or **3DVK**

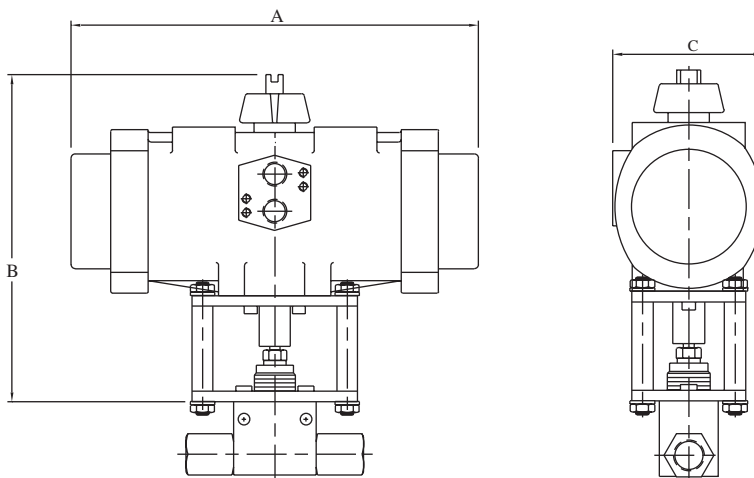

Operating Temperature Range: -20 to 175° F (-29 to 79° C)

Valve Model	Actuator Model	Dimensional Data			Air Consumption per Stroke (Free Air)	Required Air Pressure	Opening/ Closing Time
		A	B	C			
K34	RA10SRSS	5.87" (149.1)	6.85" (174.0)	3.15" (80.0)	9.0 cu in 147 cc	70 PSI 4.8 bar	0.25 sec 0.40 sec
K63	RA10SRSS	5.87" (149.1)	6.85" (174.0)	3.15" (80.0)	9.0 cu in 147 cc	70 PSI 4.8 bar	0.25 sec 0.40 sec
K103	RA10SRSS	5.87" (149.1)	6.85" (174.0)	3.15" (80.0)	9.0 cu in 147 cc	75 PSI 5.2 bar	0.25 sec 0.40 sec
K104	RA10SRSS	5.87" (149.1)	6.98" (177.3)	3.15" (80.0)	9.0 cu in 147 cc	75 PSI 5.2 bar	0.25 sec 0.40 sec
K106	RA10SRSS	5.87" (149.1)	6.98" (177.3)	3.15" (80.0)	9.0 cu in 147 cc	80 PSI 5.5 bar	0.25 sec 0.40 sec
K108	RA30SRSS	11.50" (292.1)	8.73" (221.7)	4.92" (125.0)	52.0 cu in 852 cc	80 PSI 5.5 bar	1.50 sec 2.00 sec
K204	RA10SRSS	5.87" (149.1)	6.98" (177.3)	3.15" (80.0)	9.0 cu in 147 cc	85 PSI 5.9 bar	0.25 sec 0.40 sec
K206	RA10SRSS	5.87" (149.1)	6.98" (177.3)	3.15" (80.0)	9.0 cu in 147 cc	90 PSI 6.2 bar	0.25 sec 0.40 sec
3DVK34	RA10SRSS	5.87" (149.1)	6.85" (174.0)	3.15" (80.0)	9.0 cu in 147 cc	70 PSI 4.8 bar	0.25 sec 0.40 sec
3DVK63	RA10SRSS	5.87" (149.1)	6.85" (174.0)	3.15" (80.0)	9.0 cu in 147 cc	70 PSI 4.8 bar	0.25 sec 0.40 sec
3DVK93	RA10SRSS	5.87" (149.1)	6.85" (174.0)	3.15" (80.0)	9.0 cu in 147 cc	75 PSI 5.2 bar	0.25 sec 0.40 sec
3DVK106	RA30SRSS	11.50" (292.1)	9.18" (233.2)	4.92" (125.0)	52.0 cu in 852 cc	75 PSI 5.2 bar	1.50 sec 2.00 sec
3DVK108	RA30SRSS	11.50" (292.1)	9.25" (235.0)	4.92" (125.0)	52.0 cu in 852 cc	80 PSI 5.5 bar	1.50 sec 2.00 sec
3DVK123	RA10SRSS	5.87" (149.1)	6.98" (177.3)	3.15" (80.0)	9.0 cu in 147 cc	80 PSI 5.5 bar	0.25 sec 0.40 sec
3DVK203	RA20SRSS	8.74" (222.0)	7.57" (192.3)	3.82" (97.0)	19.5 cu in 320 cc	75 PSI 5.2 bar	0.50 sec 1.00 sec
3DVK206	RA30SRSS	11.50" (292.1)	9.08" (230.6)	4.92" (125.0)	52.0 cu in 852 cc	80 PSI 5.5 bar	1.50 sec 2.00 sec

All dimensions are for reference only and are subject to change.
Dimensions in parentheses are millimeters (mm).

DOUBLE-ACTING ALUMINUM HOUSING PNEUMATIC ACTUATORS

For valve models beginning 3K

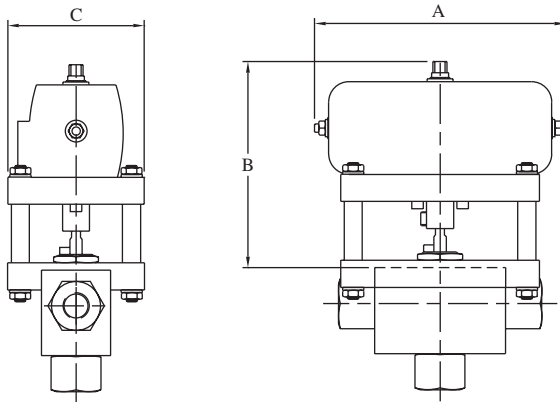

Figure 1

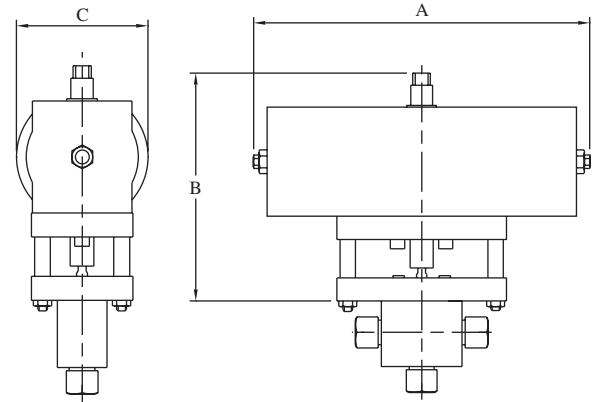

Figure 2

Operating Temperature Range: -20 to 175° F (-29 to 79° C)

Valve Model	Actuator Model	Dimensional Data			Fig.	Air Consumption per Stroke (Free Air)		Required Air Pressure	Opening/Closing Time
		A	B	C		Open	Close		
3K34	ADA180	6.69" (169.9)	4.87" (123.7)	2.69" (68.3)	1	34.8 cu in 570 cc	52.8 cu in 865 cc	80 PSI 5.5 bar	< 1 sec
3K63	ADA180	6.69" (169.9)	4.87" (123.7)	2.69" (68.3)	1	34.8 cu in 570 cc	52.8 cu in 865 cc	80 PSI 5.5 bar	< 1 sec
3K93	ADA180	6.69" (169.9)	4.87" (123.7)	2.69" (68.3)	1	34.8 cu in 570 cc	52.8 cu in 865 cc	80 PSI 5.5 bar	< 1 sec
3K123	ADA180	6.69" (169.9)	4.93" (125.2)	2.69" (68.3)	1	34.8 cu in 570 cc	52.8 cu in 865 cc	80 PSI 5.5 bar	< 1 sec
3K106	ADA180	6.69" (169.9)	5.70" (144.8)	2.69" (68.3)	1	34.8 cu in 570 cc	52.8 cu in 865 cc	80 PSI 5.5 bar	< 1 sec
3K108	AHDA180	10.92" (277.4)	6.87" (174.5)	3.25" (82.6)	2	128.8 cu in 2111 cc	128.8 cu in 2111 cc	80 PSI 5.5 bar	< 1 sec
3K206	ADA180	6.69" (169.9)	5.70" (144.8)	2.69" (68.3)	1	34.8 cu in 570 cc	52.8 cu in 865 cc	80 PSI 5.5 bar	< 1 sec
3K203	ADA180	6.69" (169.9)	4.93" (125.2)	2.69" (68.3)	1	34.8 cu in 570 cc	52.8 cu in 865 cc	80 PSI 5.5 bar	< 1 sec

All dimensions are for reference only and are subject to change.
Dimensions in parentheses are millimeters (mm).



90° UNI-DIRECTIONAL ELECTRIC ACTUATORS

For valve models beginning **K** or **3K**

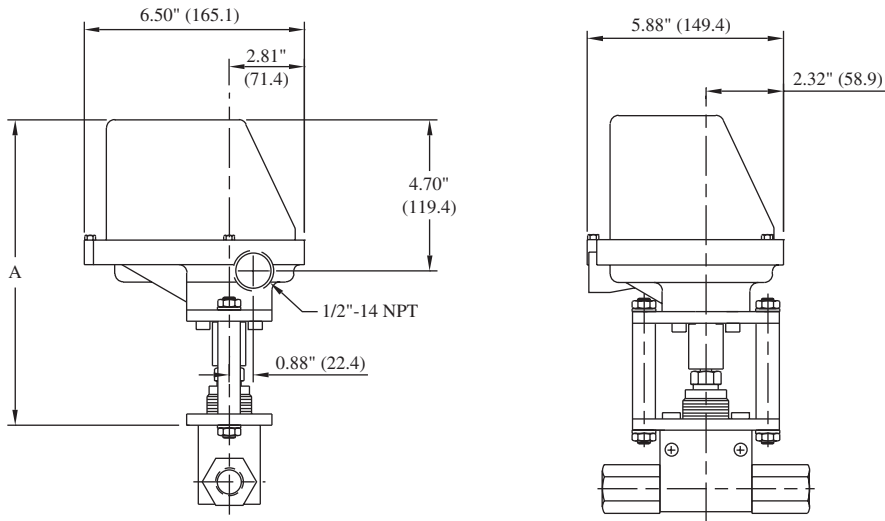

Valve Model	110/120 VAC 50/60 Hz	210/220 VAC 50/60 Hz	A	Opening/ Closing Time
K34	WE110	WE220	8.19" (208.0)	5 sec
K63 / K103	WE110	WE220	8.19" (208.0)	5 sec
K104 / K204	WE110	WE220	8.19" (208.0)	5 sec
K106 / K206	WE110	WE220	8.19" (208.0)	5 sec
K108	WHE110	WHE220	8.10" (205.7)	9 sec
3K34	WE110	WE220	8.19" (208.0)	5 sec
3K63 / 3K93	WE110	WE220	8.19" (208.0)	5 sec
3K123	WE110	WE220	8.19" (208.0)	5 sec
3K203	WE110	WE220	8.00" (203.2)	5 sec
3K106 / 3K206	WE110	WE220	8.25" (209.6)	5 sec
3K108	WHE110	WHE220	8.10" (205.7)	9 sec

Operating Temperature Range: 0 to 150° F (-18 to 65° C)

2-WAY TRUNNION VALVE

BuTech offers a 2-way trunnion valve for severe high cycle applications. These valves are constructed of the same materials as our 3-way diverting and switching valves and are designed to operate in temperatures of -20 to 400° F (-28 to 204° C). For operating at temperatures up to 550° F (288° C), specify our high temperature option (see page BV-2).

Features:

- Pressures to 20,000 PSI (1380 bar) at 72°F (22°C)
- Pressure loaded seats assure positive sealing
- Blowout-proof stem provides maximum safety
- Choice of replaceable connections for installation versatility
- Double-ended trunnion mounted ball
- Reinforced PEEK trunnion bearings and high-temperature o-rings for temperatures up to 550°F (288°C)
- Bi-directional flow capabilities

Available Models:

Model No.	Maximum Pressure*	Port	Cv	Page
3K341	3,000 PSI 210 bar	0.250" (6.4 mm)	1.40	BV-21
3K631	6,000 PSI 410 bar	0.187" (4.7 mm)	0.75	BV-22
3K931	10,000 PSI 690 bar	0.187" (4.7 mm)	0.75	BV-24
3K1061	10,000 PSI 690 bar	0.375" (9.5 mm)	3.40	BV-26
3K1081	10,000 PSI 690 bar	0.500" (12.7 mm)	10.00	BV-28
3K1231	12,000 PSI 830 bar	0.187" (4.7 mm)	0.75	BV-30
3K2031	20,000 PSI 1380 bar	0.187" (4.7 mm)	0.75	BV-32
3K2061	20,000 PSI 1380 bar	0.375" (9.5 mm)	3.40	BV-34

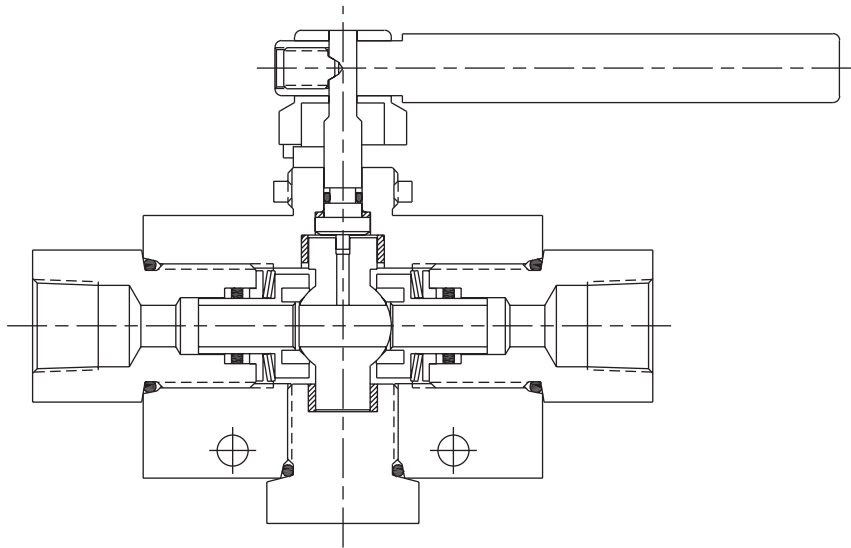

***CAUTION:** The maximum allowable working pressure (MAWP) of the valve shall not exceed the MAWP of the valve series or the selected connection, whichever is less.



All dimensions are for reference only and are subject to change.
Dimensions in parentheses are millimeters (mm).

6000 PSI (410 BAR) 2-WAY BALL VALVES

BuTech ball valves are available in female NPT connections and are available with special seal materials or manufactured from any machinable metal for extreme applications.

Materials of Construction:

- 316 cold-worked stainless steel body and side adapter
- 316 cold-worked stem
- PEEK ball seals
- Teflon back-ups
- Viton O-rings

Applications:

- All types of instrumentation
- Laboratories
- Refineries
- Hydraulic and pneumatic piping
- Gauge shut-off and vent
- Control panels
- Chemical research
- Food processing
- Pilot plants
- Water blasting
- Test stands

Features:

- Pressures to 6,000 PSI (410 bar) at 72°F (22°C)
- Pressure loaded seats assure positive sealing
- Blowout-proof stem and ball provide maximum safety
- Choice of replaceable connections for installation versatility
- Straight-through flow path minimizes pressure drop
- Quarter-turn operation accommodates quick open and close needs
- Flow indicating handle indicates valve position at a glance
- Bi-directional flow capabilities

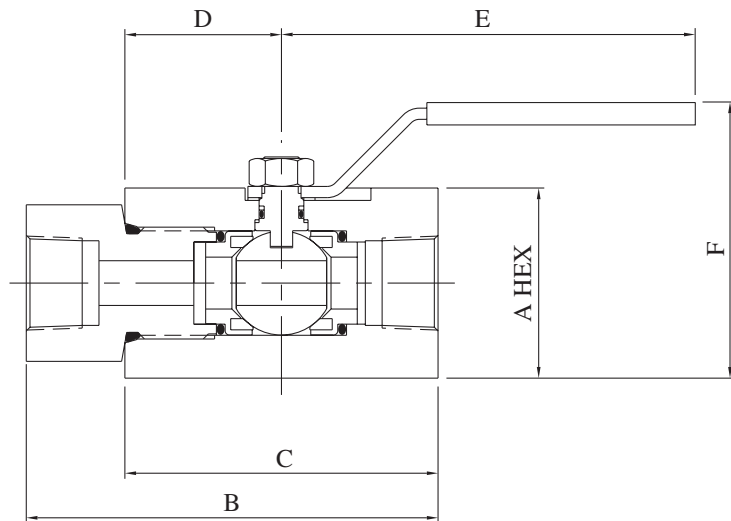

Catalog Number	Connection	Port	Cv	A	B	C	D	E	F
H64	3/8" NPT	0.250" (6.4)	1.40	1.37" (34.8)	3.09" (78.5)	2.25" (57.2)	1.00" (25.4)	3.75" (95.3)	2.06" (52.3)
H66	1/2" NPT	0.375" (9.5)	3.40	1.75" (44.5)	3.95" (100.3)	3.00" (76.2)	1.37" (34.8)	4.50" (114.3)	2.66" (67.6)
H68	3/4" NPT	0.500" (12.7)	10.00	2.12" (53.8)	4.60" (116.8)	3.50" (88.9)	1.75" (44.5)	4.50" (114.3)	2.89" (73.4)

All dimensions are for reference only and are subject to change.
Dimensions in parentheses are millimeters (mm).

PIPE VALVES AND FITTINGS

BuTech Pipe Valves are designed for liquid and gas flow control in petroleum, chemical, power generating and general industrial applications.

Available in a variety of body styles, the valves are designed for manual operation in temperatures ranging from -100° to +600°F (-73° to +315°C). Optional packings and/or extended stuffing boxes increase the range to -423° to +1200°F (-253° to +648°C).

Their rugged construction provides assurance of fail-safe operation at pressures ranging to 15,000 PSI (1030 bar).

Pipe Sizes: 1/8" through 1"
Pressures to 15,000 PSI (1030 bar)
Type: NPT

Pipe Size	Connection	SFPV/FPV Series		DHP Series		MAWP+
		Orifice	Cv*	Orifice	Cv*	
1/8"	1/8" NPT	0.187" (4.7 mm)	0.65	0.187" (4.7 mm)	0.60	15,000 PSI 1030 bar
1/4"	1/4" NPT	0.250" (6.4 mm)	0.75	0.250" (6.4 mm)	0.73	15,000 PSI 1030 bar
3/8"	3/8" NPT	0.312" (7.9 mm)	1.75	0.250" (6.4 mm)	0.73	15,000 PSI 1030 bar
1/2"	1/2" NPT	0.312" (7.9 mm)	1.75	0.250" (6.4 mm)	1.75	15,000 PSI 1030 bar
3/4"	3/4" NPT	0.562" (14.3 mm)	3.40	0.687" (17.4 mm)	5.20	10,000 PSI 690 bar
1"	1" NPT	0.562" (14.3 mm)	3.40	0.687" (17.4 mm)	5.20	10,000 PSI 690 bar

*Cv values listed are for 2-way straight pattern valves excluding metering valves.

For 2-way angle pattern valves, increase Cv value by 50%.

For Metering Valves: Cv=.004, Port size=0.062" (1.57 mm)

+Maximum allowable working pressure at 72° F (22° C)

Needle Valve Features:

- Non-rotating stem prevents galling and scoring
- Five stem styles:
 - Vee
 - Regulating
 - Soft Tip
 - Metering
 - Micro-Metering
- 17-4PH Stem for longer service life. 316 wetted parts are also available by specifying option **-316WP** (see page NPT-3)
- Glass-filled teflon packing for temperatures to 600°F (315°C)
- Integral through holes for bracket mounting. A panel-mounting option is also available (see page NPT-3)
- Wide range of options allow customizing of valve

Materials of Construction

Standard materials of construction include 316 cold-worked stainless steel, 17-4PH, Ampco 45, and glass-filled teflon. All BuTech equipment may also be produced in any machinable metal. Some of the more common exotic materials used are:

Hastelloy™
 Inconel™
 Titanium
 Monel 400™

Equipment	Page
Adapters	NPT-21
Bulkhead Couplings	NPT-20
Caps	NPT-23
Check Valves	NPT-25
Couplings	NPT-22
Crosses	NPT-20
Elbows	NPT-18
Filters	NPT-27
Manifold Valves	NPT-16
Metering and Needle Valves, 1/8"	NPT-4
Metering and Needle Valves, 1/4"	NPT-6
Metering and Needle Valves, 3/8"	NPT-8
Needle Valves, 1/2"	NPT-10
Needle Valves, 3/4"	NPT-12
Needle Valves, 1"	NPT-14
Nipples	NPT-24
Options	NPT-3
Plugs	NPT-23
Replaceable Seat Valves	NPT-17
Safety Heads	NPT-28
Tees	NPT-19
Zero-Clearance Unions	NPT-23

All dimensions are for reference only and are subject to change.
 Dimensions in parentheses are millimeters (mm)



ORDERING INFORMATION & REPLACEMENT PARTS

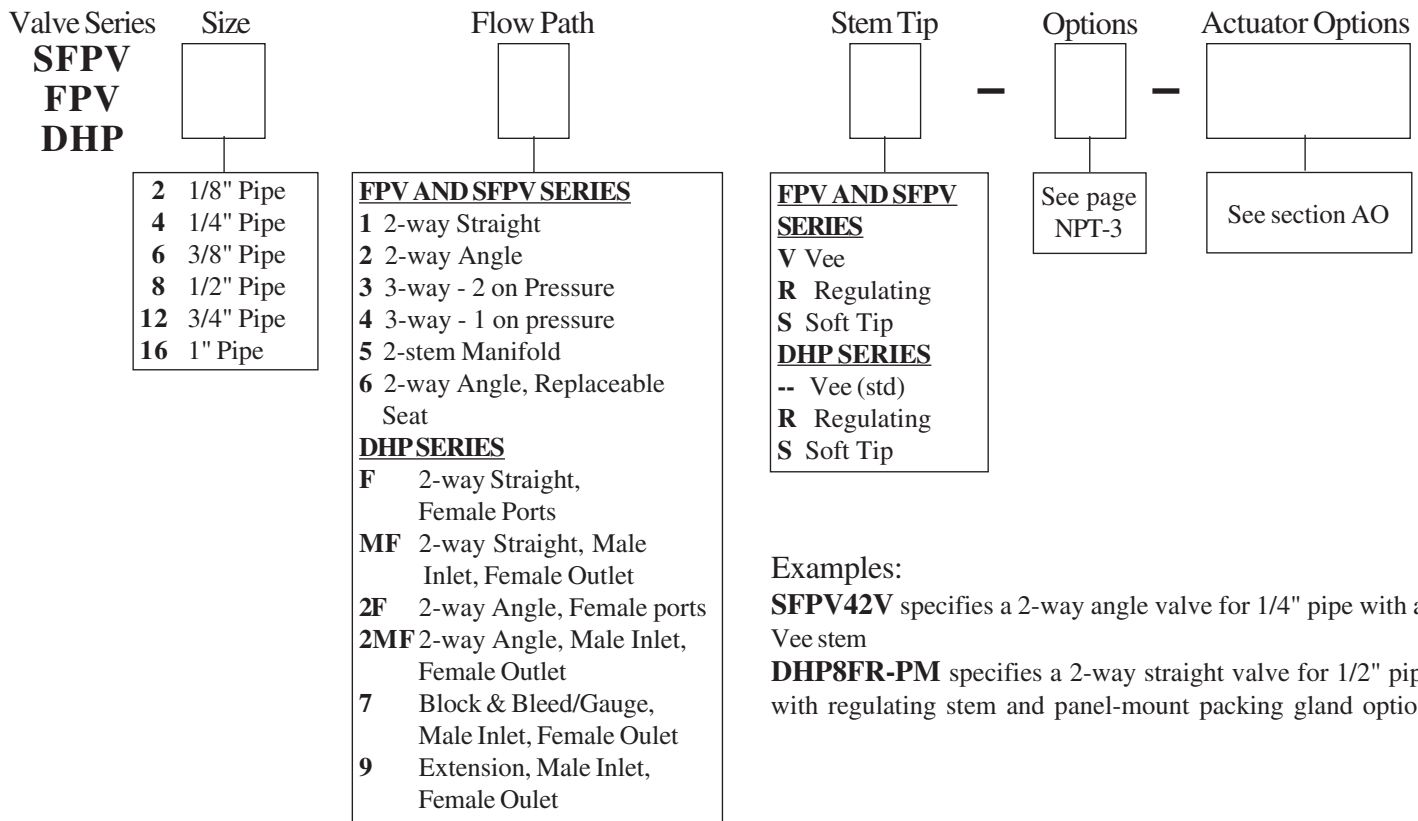

Examples:

SFPV42V specifies a 2-way angle valve for 1/4" pipe with a Vee stem

DHP8FR-PM specifies a 2-way straight valve for 1/2" pipe with regulating stem and panel-mount packing gland option

Replacement Parts

BuTech offers replacement parts in a variety of packages so you can purchase just the parts you need.

Replacement Stem Kit contains just the stem

Replacement Packing Kit contains all soft packing rings

Repair Kits contain stem, stem sleeve, stem nuts and washers, packings and packing washers (replacement seat where applicable)

Valve Series	Repair Kits		Replacement Stem	Replacement Packings	Replacement Valve Body
	All others	Replaceable Seat			
SFPV2	RK-SFPV2*	RK-SFPV26*	FPS2*	FPPK2	SFPV2+
SFPV4	RK-SFPV4*	RK-SFPV46*	FPS4*	FPPK4	SFPV4+
SFPV6	RK-SFPV6*	RK-SFPV66*	FPS6*	FPPK6	SFPV6+
SFPV8	RK-SFPV8*	RK-SFPV86*	FPS8*	FPPK8	SFPV8+
FPV12	RK-FPV12*	RK-FPV126*	FPS12*	FPPK12	FPV12+
FPV16	RK-FPV16*	RK-FPV166*	FPS16*	FPPK16	FPV16+
DHP	RK-DHP**	----	DHPS**	DHPPK**	DHP++-BO

*Complete catalog number by adding the following:

V, R or S for stem type

Suffix for special packing materials (see page NPT-3)
(ex. **-GR** for Grafoil packings)

Suffix for special materials
(ex. **-HC** for Hastelloy)

-LT or **-HT** for cryogenic or high-temperature service

-WAO for a valve fitted with an actuator

**Complete catalog number by adding the size designator from above

+Complete catalog number by adding the flow path designator:

- 1** 2-way straight
- 2** 2-way angle
- 3** 3-way, 2 connections on pressure
- 4** 3-way, 1 connection on pressure
- 5** 2-stem manifold
- 6** 2-way angle with replaceable seat

++Complete catalog number by adding the flow path designator:

- F** 2-way straight, female ports
- MF** 2-way straight male inlet, female outlet
- 2F** 2-way angle, female ports
- 2MF** 2-way angle male inlet, female outlet
- 7** Block & Bleed/Gauge, male inlet, female outlet
- 9** Extension male inlet, female outlet

All dimensions are for reference only and are subject to change.
Dimensions in parentheses are millimeters (mm)



NEEDLE VALVE OPTIONS

Packing and Stem Materials

- GR Grafoil packings for service to 800°F (426°C)
- TFE Virgin Teflon packing for service to 450°F (232°C)
- 316WP 316 wetted parts
- STS Stellite tipped stem
- SRS Stellite replaceable seat (Replaceable seat valves only)

Handle Options

- PH Round plastic handle in place of aluminum (available on 1/8" through 1/2" sizes)
- SS Stainless steel handle in place of aluminum (available on 1/8" through 1/2" sizes, on 3/4" and 1" SS is standard)
- EXT_ Handle extended above valve body, specify number of inches of extra height desired (Ex: **EXT6** is a 6" extension)

Security Options

- HLD Handle locking device (prevents unauthorized opening/closing of valve)
- SLD Stem locking device (prevents stem from turning due to vibration)

Extreme Service

- O2 Cleaned for oxygen service
- HT Extended stuffing box and special materials for high-temperature service to 1200°F (648°C)
- HTF Finned extended stuffing box and special materials for high-temperature service to 1200°F (648°C)
- LT Extended stuffing box and special materials for cryogenic service to -423°F (-251°C)
- LTF Finned extended stuffing box and special materials for cryogenic service to -423°F (-251°C)

Valve Model	A
SFPV2	5.82"
SFPV4	(147.8)
SFPV6	7.22"
SFPV8	(183.4)
FPV12	10.76"
FPV16	(273.3)
DHP2	5.82"
DHP4	
DHP6	
DHP8	
DHP12	10.85"
DHP16	
	(275.6)

-HT or -LT Options

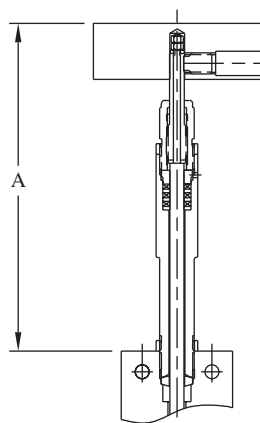

Cylindrical Bonnet

-HTF or -LTF Options

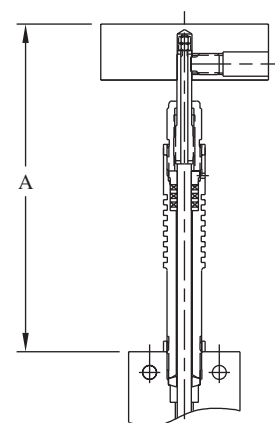

Finned Bonnet

Panel Mount

- PM Panel-mount packing gland

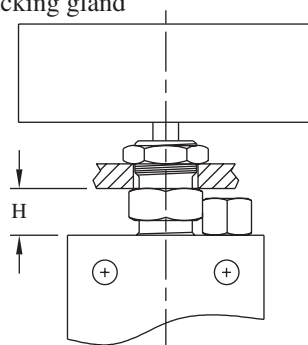

Valve Model	Panel Hole Size	Max Panel Thickness	H
SFPV2	0.66"	0.25"	0.54"
SFPV4	(16.8)	(6.4)	(13.7)
SFPV6	0.78"	0.44"	0.50"
SFPV8	(19.8)	(11.2)	(12.7)
FPV12	1.41"	0.62"	0.97"
FPV16	(35.8)	(15.7)	(24.6)
DHP2	0.64"	0.44"	0.50"
DHP4			
DHP6			
DHP8			
DHP12	1.41"	0.62"	1.03"
DHP16			
	(35.8)	(15.7)	(26.2)

All dimensions are for reference only and are subject to change.
Dimensions in parentheses are millimeters (mm)

NEEDLE VALVES FOR 15,000 PSI (1030 BAR)

1/8" PIPE

2-way Straight

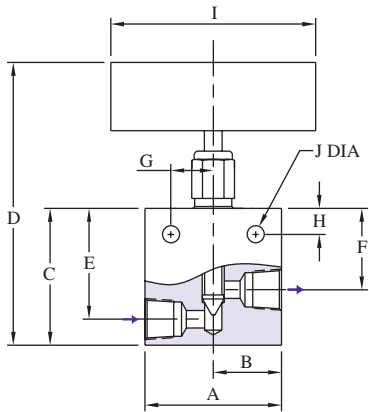

Figure 1

2-way Angle

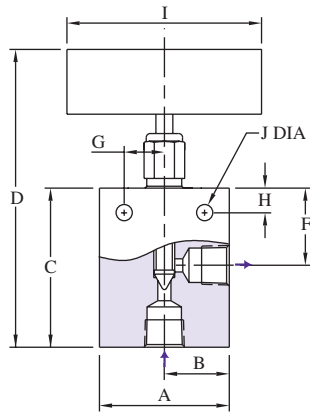

Figure 2

3-way Two on Pressure

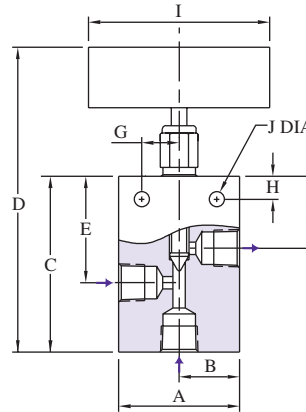

Figure 3

3-way One on Pressure

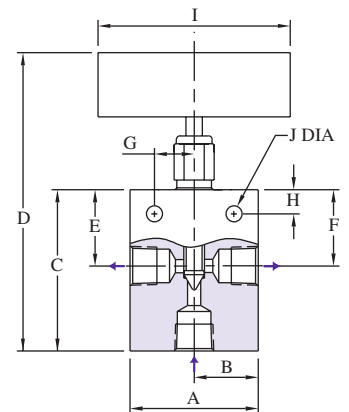

Figure 4

Catalog Number	Stem Style	Connection	A	B	C	D	E	F	G	H	I	J	K	L	Thk.	Fig
SFPV21V SFPV21R	Vee Reg	1/8" NPT	2.00" (50.8)	1.00" (25.4)	2.00" (50.8)	4.50" (114.3)	1.62" (41.1)	1.19" (30.2)	0.62" (15.7)	0.38" (9.7)	3.00" (76.2)	0.25" (6.4)	---	---	0.75" (19.1)	1
SFPV22V SFPV22R	Vee Reg	1/8" NPT	2.00" (50.8)	1.00" (25.4)	2.44" (62.0)	4.94" (125.5)	---	1.19" (30.2)	0.62" (15.7)	0.38" (9.7)	3.00" (76.2)	0.25" (6.4)	---	---	0.75" (19.1)	2
SFPV23V SFPV23R	Vee Reg	1/8" NPT	2.00" (50.8)	1.00" (25.4)	2.62" (66.5)	5.12" (130.0)	1.62" (41.1)	1.19" (30.2)	0.62" (15.7)	0.38" (9.7)	3.00" (76.2)	0.25" (6.4)	---	---	0.75" (19.1)	3
SFPV24V SFPV24R	Vee Reg	1/8" NPT	2.00" (50.8)	1.00" (25.4)	2.44" (62.0)	4.94" (125.5)	1.19" (30.2)	1.19" (30.2)	0.62" (15.7)	0.38" (9.7)	3.00" (76.2)	0.25" (6.4)	---	---	0.75" (19.1)	4
SFPV25V SFPV25R	Vee Reg	1/8" NPT	2.00" (50.8)	1.00" (25.4)	3.38" (85.9)	8.38" (212.9)	1.68" (42.7)	1.19" (30.2)	0.62" (15.7)	0.38" (9.7)	3.00" (76.2)	0.25" (6.4)	---	---	0.75" (19.1)	5
SFPV26V SFPV26R	Vee Reg	1/8" NPT	2.00" (50.8)	1.00" (25.4)	2.25" (57.2)	4.75" (120.7)	---	1.19" (30.2)	0.62" (15.7)	0.38" (9.7)	3.00" (76.2)	0.25" (6.4)	0.75" (19.1)	0.87" (22.1)	0.75" (19.1)	6
SFPMV26V	Meter	1/8" NPT	1.37" (34.8)	0.87" (22.1)	1.56" (39.6)	4.70" (119.4)	---	0.94" (23.9)	1.19" (30.2)	0.44" (11.2)	2.37" (60.2)	0.16" (4.1)	0.62" (15.7)	0.71" (18.0)	0.75" (19.1)	7
SFPMMV26V	Micro-Meter	1/8" NPT	1.37" (34.8)	0.87" (22.1)	1.56" (39.6)	5.24" (133.1)	---	0.94" (23.9)	1.19" (30.2)	0.44" (11.2)	2.37" (60.2)	0.16" (4.1)	0.62" (15.7)	0.71" (18.0)	0.75" (19.1)	8

See page NPT-1 for orifice and Cv

2-stem Manifold

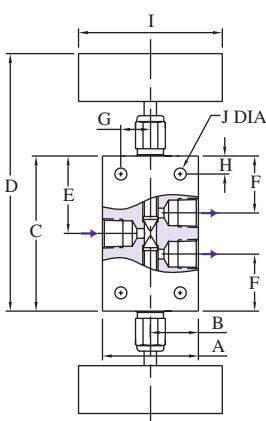

Figure 5

Replaceable Seat

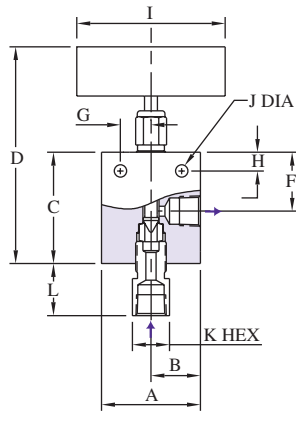

Figure 6

Metering

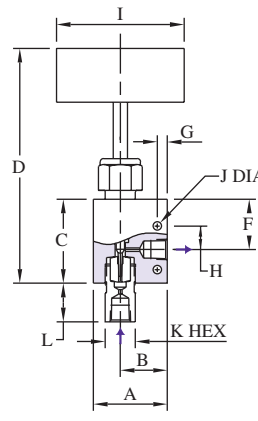

Figure 7

Micro-Metering

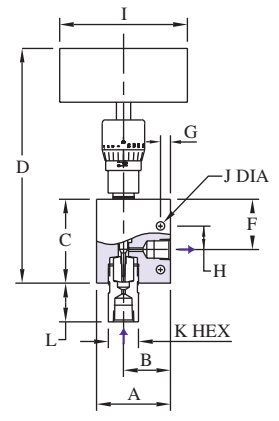

Figure 8

All dimensions are for reference only and are subject to change.
Dimensions in parentheses are millimeters (mm)

NEEDLE VALVES FOR 15,000 PSI (1030 BAR)

1/8" PIPE

**2-way Straight
Female Ports**

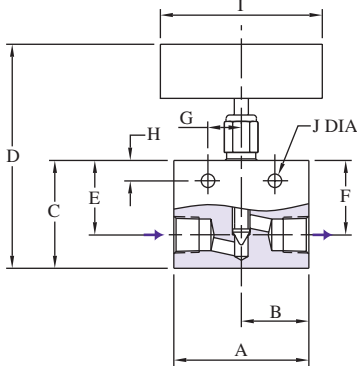

Figure 9

**2-way Straight
Male Inlet, Female Outlet**

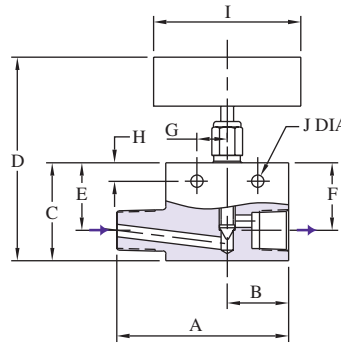

Figure 10

**2-way Angle
Male Inlet, Female Outlet**

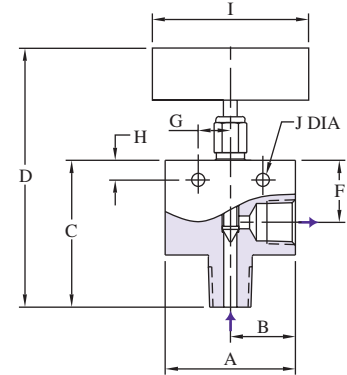

Figure 11

Catalog Number	Connection	A	B	C	D	E	F	G	H	I	J	K	L	Thk.	Fig
DHP2F	1/8" NPT	2.50" (63.5)	1.25" (31.8)	2.00" (50.8)	4.50" (114.3)	1.38" (35.1)	1.38" (35.1)	0.62" (15.7)	0.38" (9.7)	3.00" (76.2)	0.25" (6.4)	---	---	1.00" (25.4)	9
DHP2MF	1/8" NPT	3.06" (77.7)	1.25" (31.8)	2.00" (50.8)	4.50" (114.3)	1.38" (35.1)	1.38" (35.1)	0.62" (15.7)	0.38" (9.7)	3.00" (76.2)	0.25" (6.4)	---	---	1.00" (25.4)	10
DHP22MF	1/8" NPT	2.00" (50.8)	1.00" (25.4)	2.43" (61.7)	4.93" (125.2)	---	1.19" (30.2)	0.62" (15.7)	0.38" (9.7)	3.00" (76.2)	0.25" (6.4)	---	---	1.00" (25.4)	11
DHP27	1/8" NPT	5.38" (136.7)	1.50" (38.1)	2.00" (50.8)	4.50" (114.3)	1.19" (30.2)	1.19" (30.2)	0.62" (15.7)	0.38" (9.7)	3.00" (76.2)	0.25" (6.4)	2.97" (75.4)	1/8" FNPT	1.25" (31.8)	12
DHP29	1/8" NPT	6.10" (154.9)	1.25" (31.8)	1.19" (30.2)	4.50" (114.3)	2.00" (50.8)	1.19" (30.2)	0.62" (15.7)	0.38" (9.7)	3.00" (76.2)	0.25" (6.4)	2.87" (72.9)	---	1.00" (25.4)	13

See page NPT-1 for orifice and Cv

**Block & Bleed/Gauge
Male Inlet, Female Outlet**

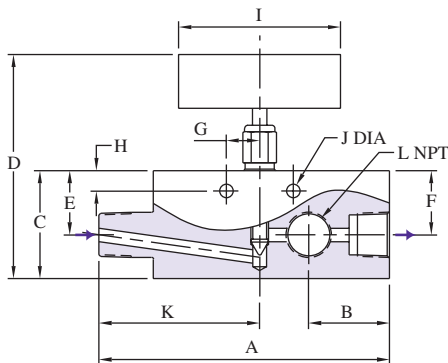

Figure 12

**Extension
Male Inlet, Female Outlet**

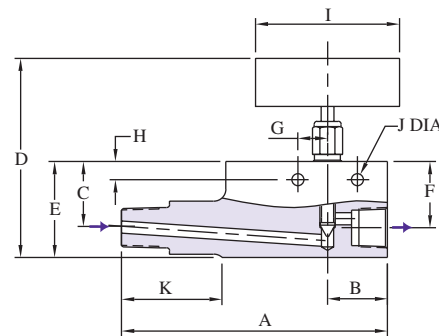

Figure 13

All dimensions are for reference only and are subject to change.
Dimensions in parentheses are millimeters (mm)



NEEDLE VALVES FOR 15,000 PSI (1030 BAR)

1/4" PIPE

2-way Straight

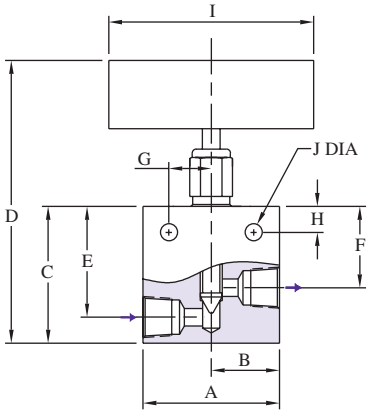

Figure 1

2-way Angle

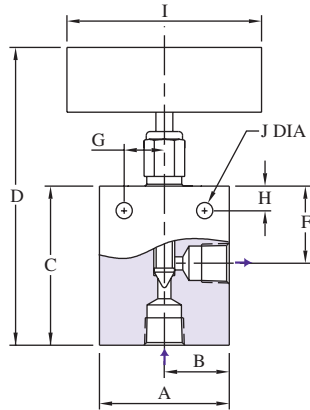

Figure 2

3-way Two on Pressure

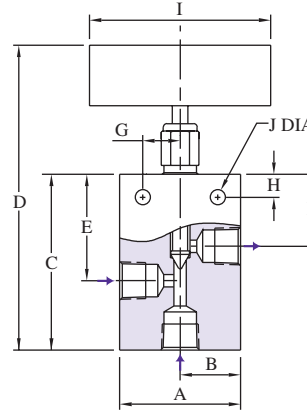

Figure 3

3-way One on Pressure

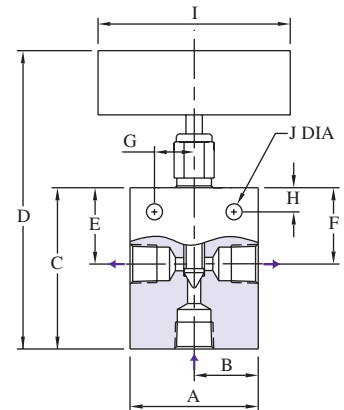

Figure 4

Catalog Number	Stem Style	Connection	A	B	C	D	E	F	G	H	I	J	K	L	Thk.	Fig
SFPV41V SFPV41R	Vee Reg	1/4" NPT	2.00" (50.8)	1.00" (25.4)	2.00" (50.8)	4.50" (114.3)	1.62" (41.1)	1.19" (30.2)	0.62" (15.7)	0.38" (9.7)	3.00" (76.2)	0.25" (6.4)	---	---	0.75" (19.1)	1
SFPV42V SFPV42R	Vee Reg	1/4" NPT	2.00" (50.8)	1.00" (25.4)	2.44" (62.0)	4.94" (125.5)	---	1.19" (30.2)	0.62" (15.7)	0.38" (9.7)	3.00" (76.2)	0.25" (6.4)	---	---	0.75" (19.1)	2
SFPV43V SFPV43R	Vee Reg	1/4" NPT	2.00" (50.8)	1.00" (25.4)	2.62" (66.5)	5.12" (130.0)	1.62" (41.1)	1.19" (30.2)	0.62" (15.7)	0.38" (9.7)	3.00" (76.2)	0.25" (6.4)	---	---	0.75" (19.1)	3
SFPV44V SFPV44R	Vee Reg	1/4" NPT	2.00" (50.8)	1.00" (25.4)	2.44" (62.0)	4.94" (125.5)	1.19" (30.2)	1.19" (30.2)	0.62" (15.7)	0.38" (9.7)	3.00" (76.2)	0.25" (6.4)	---	---	0.75" (19.1)	4
SFPV45V SFPV45R	Vee Reg	1/4" NPT	2.00" (50.8)	1.00" (25.4)	3.38" (85.9)	8.38" (212.9)	1.69" (42.9)	1.19" (30.2)	0.62" (15.7)	0.38" (9.7)	3.00" (76.2)	0.25" (6.4)	---	---	0.75" (19.1)	5
SFPV46V SFPV46R	Vee Reg	1/4" NPT	2.00" (50.8)	1.00" (25.4)	2.25" (57.2)	4.75" (120.7)	---	1.19" (30.2)	0.62" (15.7)	0.38" (9.7)	3.00" (76.2)	0.25" (6.4)	0.75" (19.1)	0.87" (22.1)	0.75" (19.1)	6
SFPMV46V	Meter	1/4" NPT	2.50" (63.5)	1.25" (31.8)	2.62" (66.5)	5.66" (143.8)	---	1.31" (33.3)	0.69" (17.5)	0.38" (9.7)	3.00" (76.2)	0.25" (6.4)	0.75" (19.1)	1.02" (25.9)	1.00" (25.4)	7
SFPMV46V	Micro-Meter	1/4" NPT	2.50" (63.5)	1.25" (31.8)	2.62" (66.5)	6.30" (160.0)	---	1.31" (33.3)	0.69" (17.5)	0.38" (9.7)	2.35" (59.7)	0.25" (6.4)	0.75" (19.1)	1.02" (25.9)	1.00" (25.4)	8

See page NPT-1 for orifice and Cv

2-stem Manifold

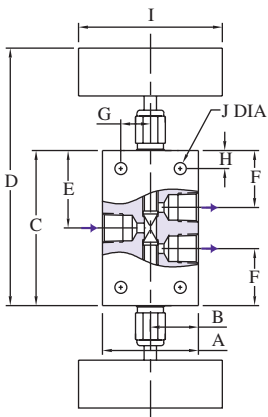

Figure 5

Replaceable Seat

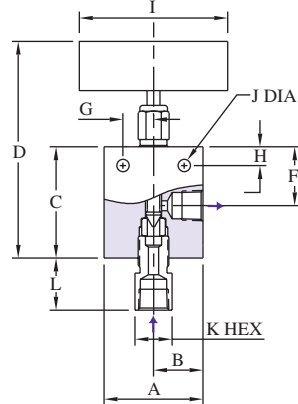

Figure 6

Metering

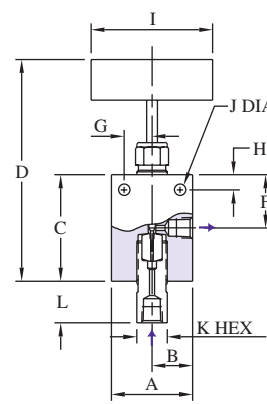

Figure 7

Micro-Metering

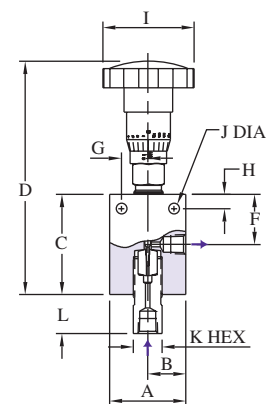

Figure 8

All dimensions are for reference only and are subject to change.
Dimensions in parentheses are millimeters (mm)

NEEDLE VALVES FOR 15,000 PSI (1030 BAR)

1/4" PIPE

**2-way Straight
Female Ports**

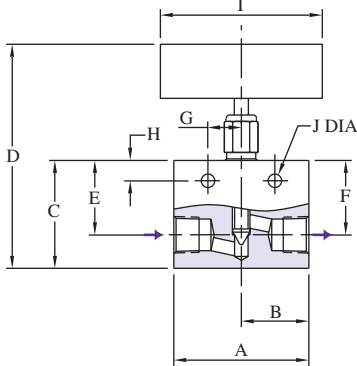

Figure 9

**2-way Straight
Male Inlet, Female Outlet**

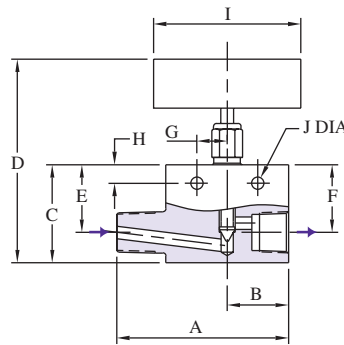

Figure 10

**2-way Angle
Male Inlet, Female Outlet**

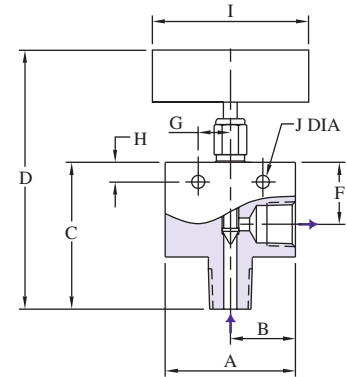

Figure 11

Catalog Number	Connection	A	B	C	D	E	F	G	H	I	J	K	L	Thk.	Fig
DHP4F	1/4" NPT	2.50" (63.5)	1.25" (31.8)	2.00" (50.8)	4.50" (114.3)	1.38" (35.1)	1.38" (35.1)	0.62" (15.7)	0.38" (9.7)	3.00" (76.2)	0.25" (6.4)	---	---	1.00" (25.4)	9
DHP4MF	1/4" NPT	3.50" (88.9)	1.25" (31.8)	2.00" (50.8)	4.50" (114.3)	1.38" (35.1)	1.38" (35.1)	0.62" (15.7)	0.38" (9.7)	3.00" (76.2)	0.25" (6.4)	---	---	1.00" (25.4)	10
DHP42MF	1/4" NPT	2.00" (50.8)	1.00" (25.4)	2.43" (61.7)	4.93" (125.2)	---	1.19" (30.2)	0.62" (15.7)	0.38" (9.7)	3.00" (76.2)	0.25" (6.4)	---	---	1.00" (25.4)	11
DHP47	1/4" NPT	4.50" (114.3)	1.34" (34.0)	2.00" (50.8)	4.50" (114.3)	1.37" (34.8)	1.37" (34.8)	0.62" (15.7)	0.38" (9.7)	3.00" (76.2)	0.25" (6.4)	2.25" (57.2)	1/4" FNPT	1.25" (31.8)	12
DHP49	1/4" NPT	6.10" (154.9)	1.25" (31.8)	2.00" (50.8)	4.50" (114.3)	1.19" (30.2)	1.19" (30.2)	0.62" (15.7)	0.38" (9.7)	3.00" (76.2)	0.25" (6.4)	2.87" (72.9)	---	1.00" (25.4)	13

See page NPT-1 for orifice and Cv

**Block & Bleed/Gauge
Male Inlet, Female Outlet**

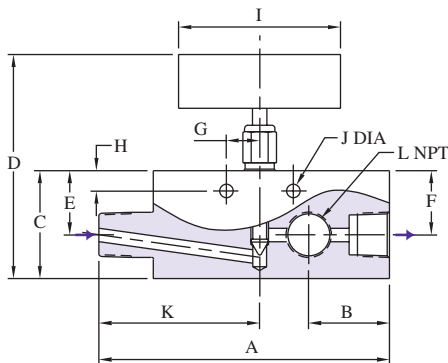

Figure 12

**Extension
Male Inlet, Female Outlet**

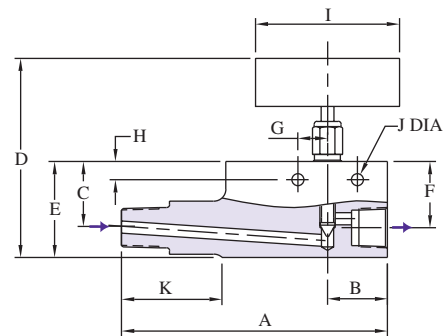

Figure 13

All dimensions are for reference only and are subject to change.
Dimensions in parentheses are millimeters (mm)



NEEDLE VALVES FOR 15,000 PSI (1030 BAR)

3/8" PIPE

2-way Straight

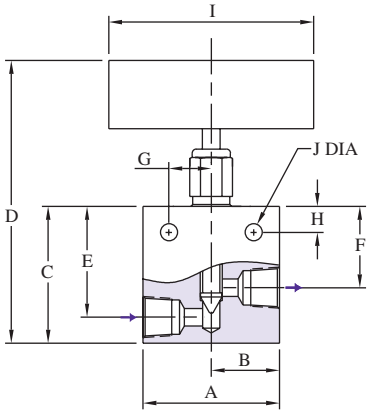

Figure 1

2-way Angle

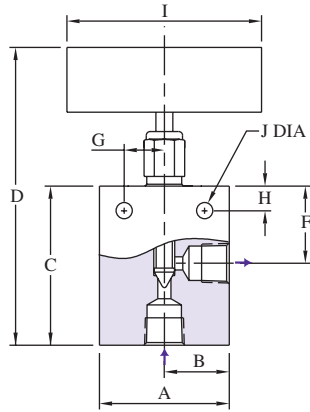

Figure 2

3-way Two on Pressure

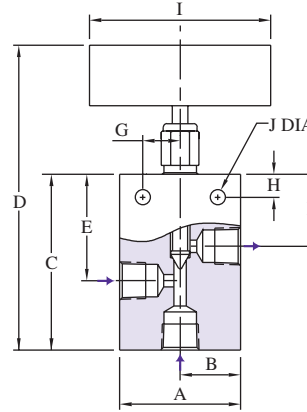

Figure 3

3-way One on Pressure

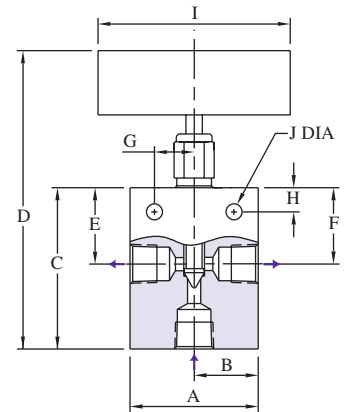

Figure 4

Catalog Number	Stem Style	Connection	A	B	C	D	E	F	G	H	I	J	K	L	Thk.	Fig
SFPV61V	Vee	3/8" NPT	2.50"	1.25"	2.88"	6.32"	2.38"	1.75"	0.69"	0.50"	4.00"	0.34"	---	---	1.00"	1
SFPV61R	Reg	3/8" NPT	(63.5)	(31.8)	(73.2)	(160.5)	(60.5)	(44.5)	(17.5)	(12.7)	(101.6)	(8.6)	---	---	(25.4)	
SFPV62V	Vee	3/8" NPT	2.50"	1.25"	3.38"	6.82"	---	1.75"	0.69"	0.50"	4.00"	0.34"	---	---	1.00"	2
SFPV62R	Reg	3/8" NPT	(63.5)	(31.8)	(85.9)	(173.2)	---	(44.5)	(17.5)	(12.7)	(101.6)	(8.6)	---	---	(25.4)	
SFPV63V	Vee	3/8" NPT	2.50"	1.25"	3.62"	7.06"	2.38"	1.75"	0.69"	0.50"	4.00"	0.34"	---	---	1.00"	3
SFPV63R	Reg	3/8" NPT	(63.5)	(31.8)	(91.9)	(179.3)	(60.5)	(44.5)	(17.5)	(12.7)	(101.6)	(8.6)	---	---	(25.4)	
SFPV64V	Vee	3/8" NPT	2.50"	1.25"	3.38"	6.82"	1.75"	1.75"	0.69"	0.50"	4.00"	0.34"	---	---	1.00"	4
SFPV64R	Reg	3/8" NPT	(63.5)	(31.8)	(85.9)	(173.2)	(44.5)	(44.5)	(17.5)	(12.7)	(101.6)	(8.6)	---	---	(25.4)	
SFPV65V	Vee	3/8" NPT	2.50"	1.25"	5.12"	12.00"	2.56"	1.75"	0.69"	0.50"	4.00"	0.34"	---	---	1.00"	5
SFPV65R	Reg	3/8" NPT	(63.5)	(31.8)	(130.0)	(304.8)	(65.0)	(44.5)	(17.5)	(12.7)	(101.6)	(8.6)	---	---	(25.4)	
SFPV66V	Vee	3/8" NPT	2.50"	1.25"	3.25"	6.69"	---	1.75"	0.69"	0.50"	4.00"	0.34"	1.00"	1.22"	1.00"	6
SFPV66R	Reg	3/8" NPT	(63.5)	(31.8)	(82.6)	(169.9)	---	(44.5)	(17.5)	(12.7)	(101.6)	(8.6)	(25.4)	(31.0)	(25.4)	
SFPMV66V	Meter	3/8" NPT	2.50"	1.25"	2.62"	5.66"	---	1.31"	0.69"	0.38"	4.00"	0.25"	1.00"	1.12"	1.00"	7
SFPMV66R	Reg	3/8" NPT	(63.5)	(31.8)	(66.5)	(143.8)	---	(33.3)	(17.5)	(9.7)	(101.6)	(6.4)	(25.4)	(28.4)	(25.4)	
SFPMMV66V	Micro-Meter	3/8" NPT	2.50"	1.25"	2.62"	6.30"	---	1.31"	0.69"	0.38"	2.35"	0.25"	1.00"	1.12"	1.00"	8
SFPMMV66R	Reg	3/8" NPT	(63.5)	(31.8)	(66.5)	(160.0)	---	(33.3)	(17.5)	(9.7)	(59.7)	(6.4)	(25.4)	(28.4)	(25.4)	

See page NPT-1 for orifice and Cv

2-stem Manifold

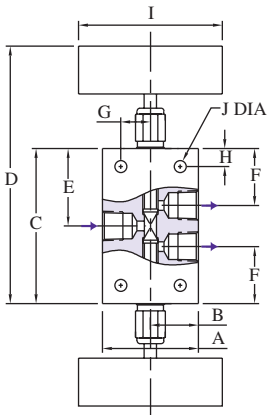

Figure 5

Replaceable Seat

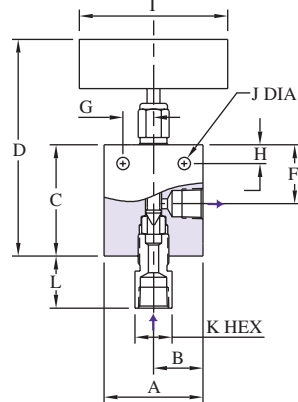

Figure 6

Metering

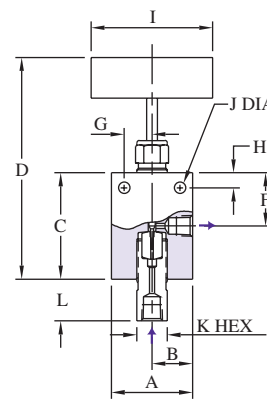

Figure 7

Micro-Metering

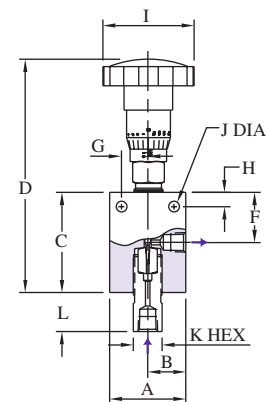

Figure 8

All dimensions are for reference only and are subject to change.
Dimensions in parentheses are millimeters (mm)

NEEDLE VALVES FOR 15,000 PSI (1030 BAR)

3/8" PIPE

**2-way Straight
Female Ports**

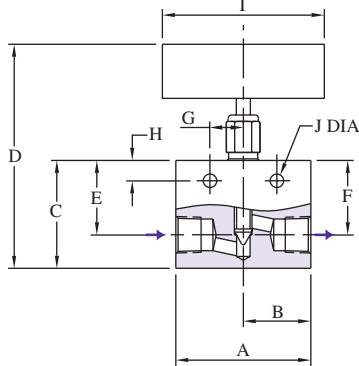

Figure 9

**2-way Straight
Male Inlet, Female Outlet**

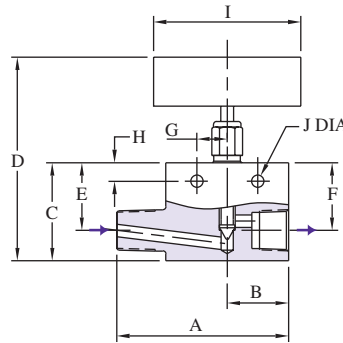

Figure 10

**2-way Angle
Male Inlet, Female Outlet**

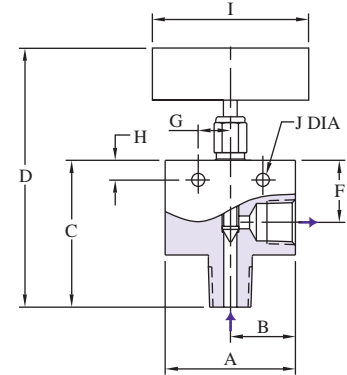

Figure 11

Catalog Number	Connection	A	B	C	D	E	F	G	H	I	J	K	L	Thk.	Fig
DHP6F	3/8" NPT	2.50" (63.5)	1.25" (31.8)	2.00" (50.8)	4.50" (114.3)	1.38" (35.1)	1.38" (35.1)	0.62" (15.7)	0.38" (9.7)	3.00" (76.2)	0.25" (6.4)	---	---	1.00" (25.4)	9
DHP6MF	3/8" NPT	3.50" (88.9)	1.25" (31.8)	2.00" (50.8)	4.50" (114.3)	1.38" (35.1)	1.38" (35.1)	0.62" (15.7)	0.38" (9.7)	3.00" (76.2)	0.25" (6.4)	---	---	1.00" (25.4)	10
DHP62MF	3/8" NPT	2.50" (63.5)	1.25" (31.8)	2.43" (61.7)	4.93" (125.2)	---	1.19" (30.2)	0.62" (15.7)	0.38" (9.7)	3.00" (76.2)	0.25" (6.4)	---	---	1.00" (25.4)	11
DHP67	3/8" NPT	5.38" (136.7)	1.50" (38.1)	2.00" (50.8)	4.50" (114.3)	1.19" (30.2)	1.19" (30.2)	0.62" (15.7)	0.38" (9.7)	3.00" (76.2)	0.25" (6.4)	2.97" (75.4)	3/8" FNPT	1.25" (31.8)	12
DHP69	3/8" NPT	6.10" (154.9)	1.25" (31.8)	2.00" (50.8)	4.50" (114.3)	1.19" (30.2)	1.19" (30.2)	0.62" (15.7)	0.38" (9.7)	3.00" (76.2)	0.25" (6.4)	2.87" (72.9)	---	1.00" (25.4)	13

See page NPT-1 for orifice and Cv

**Block & Bleed/Gauge
Male Inlet, Female Outlet**

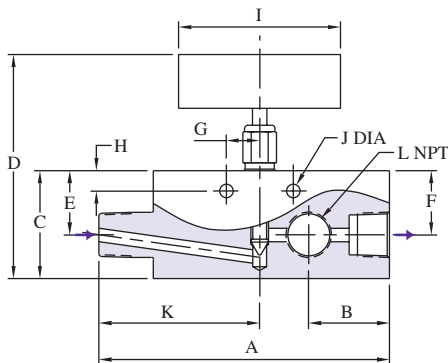

Figure 12

**Extension
Male Inlet, Female Outlet**

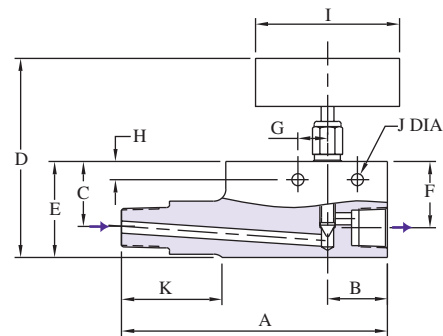

Figure 13

All dimensions are for reference only and are subject to change.
Dimensions in parentheses are millimeters (mm)

NEEDLE VALVES FOR 15,000 PSI (1030 BAR)

1/2" PIPE

2-way Straight

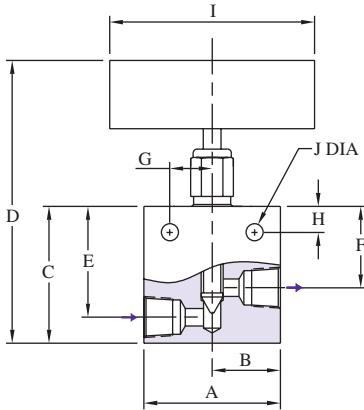

Figure 1

2-way Angle

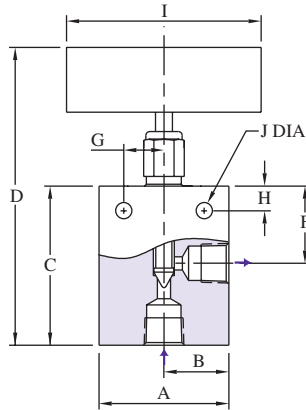

Figure 2

3-way Two on Pressure

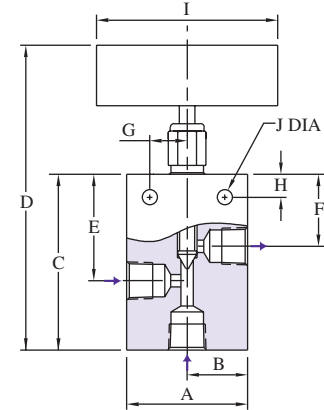

Figure 3

Catalog Number	Stem Style	Connection	A	B	C	D	E	F	G	H	I	J	K	L	Thk.	Fig
SFPV81V	Vee	1/2" NPT	2.50"	1.25"	3.00"	6.44"	2.38"	1.75"	0.69"	0.50"	4.00"	0.34"	---	---	1.25"	1
SFPV81R	Reg	1/2" NPT	(63.5)	(31.8)	(76.2)	(163.6)	(60.5)	(44.5)	(17.5)	(12.7)	(101.6)	(8.6)	---	---	(31.8)	
SFPV82V	Vee	1/2" NPT	2.50"	1.25"	3.38"	6.82"	---	1.75"	0.69"	0.50"	4.00"	0.34"	---	---	1.25"	2
SFPV82R	Reg	1/2" NPT	(63.5)	(31.8)	(85.9)	(173.2)	---	(44.5)	(17.5)	(12.7)	(101.6)	(8.6)	---	---	(31.8)	
SFPV83V	Vee	1/2" NPT	2.50"	1.25"	3.62"	7.06"	2.38"	1.75"	0.69"	0.50"	4.00"	0.34"	---	---	1.25"	3
SFPV83R	Reg	1/2" NPT	(63.5)	(31.8)	(91.9)	(179.3)	(60.5)	(44.5)	(17.5)	(12.7)	(101.6)	(8.6)	---	---	(31.8)	
SFPV84V	Vee	1/2" NPT	2.50"	1.25"	3.38"	6.44"	1.75"	1.75"	0.69"	0.50"	4.00"	0.34"	---	---	1.25"	4
SFPV84R	Reg	1/2" NPT	(63.5)	(31.8)	(85.9)	(163.6)	(44.5)	(44.5)	(17.5)	(12.7)	(101.6)	(8.6)	---	---	(31.8)	
SFPV85V	Vee	1/2" NPT	2.50"	1.25"	5.12"	12.00"	2.56"	1.75"	0.69"	0.50"	4.00"	0.34"	---	---	1.25"	5
SFPV85R	Reg	1/2" NPT	(63.5)	(31.8)	(130.0)	(304.8)	(65.0)	(44.5)	(17.5)	(12.7)	(101.6)	(8.6)	---	---	(31.8)	
SFPV86V	Vee	1/2" NPT	2.50"	1.25"	3.25"	6.69"	---	1.75"	0.69"	0.50"	4.00"	0.34"	1.38"	1.00"	1.25"	6
SFPV86R	Reg	1/2" NPT	(63.5)	(31.8)	(82.6)	(169.9)	---	(44.5)	(17.5)	(12.7)	(101.6)	(8.6)	(35.1)	(25.4)	(31.8)	

See page NPT-1 for orifice and Cv

3-way One on Pressure

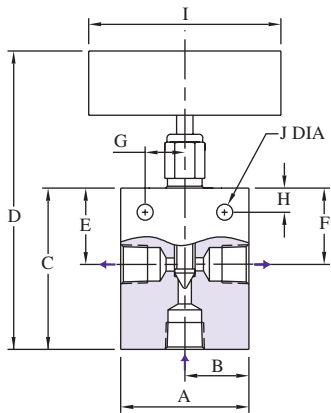

Figure 4

2-stem Manifold

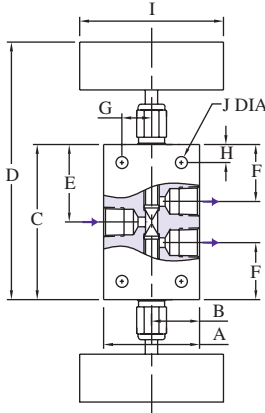

Figure 5

Replaceable Seat

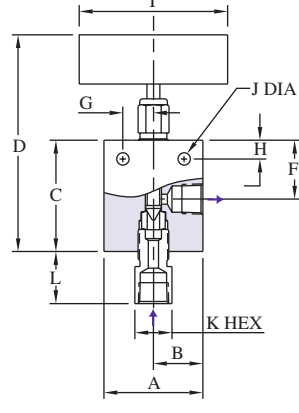

Figure 6

All dimensions are for reference only and are subject to change.
Dimensions in parentheses are millimeters (mm)

NEEDLE VALVES FOR 15,000 PSI (1030 BAR)

1/2" PIPE

**2-way Straight
Female Ports**

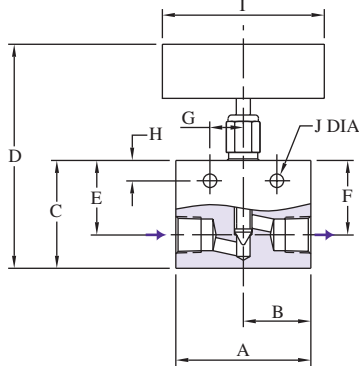

Figure 7

**2-way Straight
Male Inlet, Female Outlet**

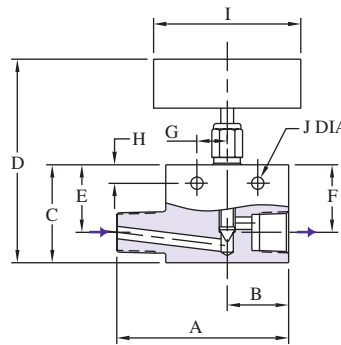

Figure 8

**2-way Angle
Male Inlet, Female Outlet**

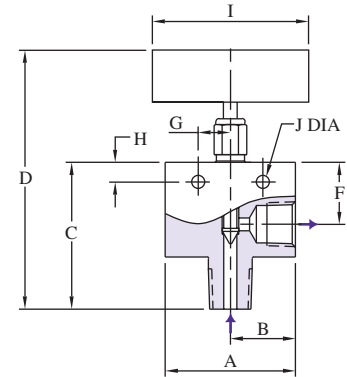

Figure 9

Catalog Number	Connection	A	B	C	D	E	F	G	H	I	J	K	L	Thk.	Fig
DHP8F	1/2" NPT	2.50" (63.5)	1.25" (31.8)	2.00" (50.8)	4.50" (114.3)	1.38" (35.1)	1.38" (35.1)	0.62" (15.7)	0.38" (9.7)	3.00" (76.2)	0.25" (6.4)	---	---	1.25" (31.8)	7
DHP8MF	1/2" NPT	3.50" (88.9)	1.25" (31.8)	2.00" (50.8)	4.50" (114.3)	1.38" (35.1)	1.38" (35.1)	0.62" (15.7)	0.38" (9.7)	3.00" (76.2)	0.25" (6.4)	---	---	1.25" (31.8)	8
DHP82MF	1/2" NPT	2.50" (63.5)	1.25" (31.8)	2.81" (71.4)	5.31" (134.9)	---	1.19" (30.2)	0.62" (15.7)	0.38" (9.7)	3.00" (76.2)	0.25" (6.4)	---	---	1.25" (31.8)	9
DHP87	1/2" NPT	5.38" (136.7)	1.50" (38.1)	2.00" (50.8)	4.50" (114.3)	1.19" (30.2)	1.19" (30.2)	0.62" (15.7)	0.38" (9.7)	3.00" (76.2)	0.25" (6.4)	2.97" (75.4)	1/2" FNPT	1.25" (31.8)	10
DHP89	1/2" NPT	6.10" (154.9)	1.25" (31.8)	2.00" (50.8)	4.50" (114.3)	1.19" (30.2)	1.19" (30.2)	0.62" (15.7)	0.38" (9.7)	3.00" (76.2)	0.25" (6.4)	2.87" (72.9)	---	1.25" (31.8)	11

See page NPT-1 for orifice and Cv

**Block & Bleed/Gauge
Male Inlet, Female Outlet**

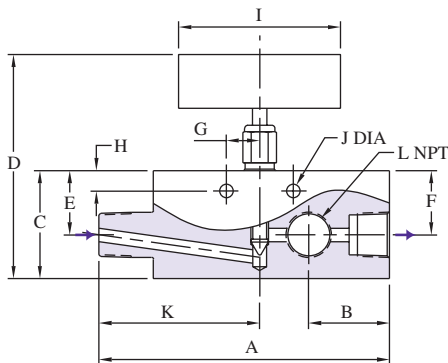

Figure 10

**Extension
Male Inlet, Female Outlet**

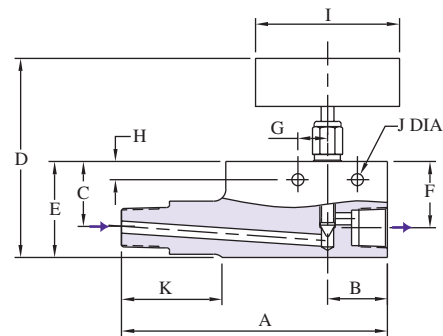

Figure 11

All dimensions are for reference only and are subject to change.
Dimensions in parentheses are millimeters (mm)



NEEDLE VALVES FOR 10,000 PSI (690 BAR)

3/4" PIPE

2-way Straight

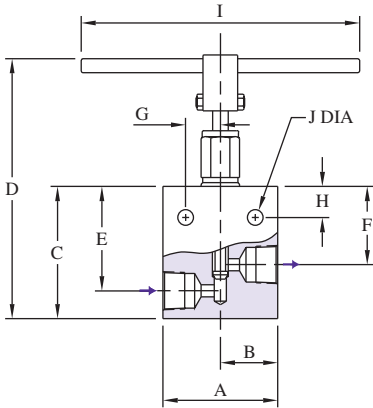

Figure 1

2-way Angle

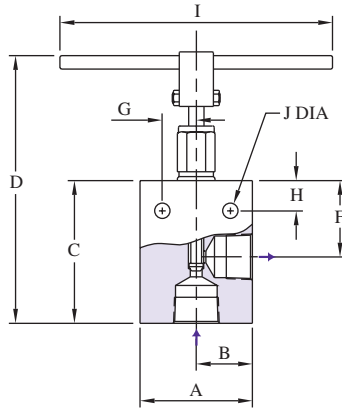

Figure 2

3-way Two on Pressure

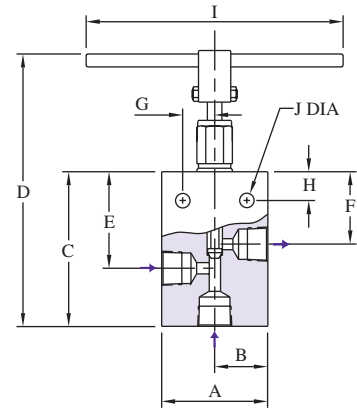

Figure 3

Catalog Number	Stem Style	Connection	A	B	C	D	E	F	G	H	I	J	K	L	Thk.	Fig
FPV121V	Vee	3/4" NPT	4.12"	2.06"	5.50"	10.94"	3.75"	2.81"	1.25"	1.12"	10.00"	0.56"	---	---	1.75"	1
FPV121R	Reg	3/4" NPT	(104.6)	(52.3)	(139.7)	(277.9)	(95.3)	(71.4)	(31.8)	(28.4)	(254.0)	(14.2)	---	---	(44.5)	
FPV122V	Vee	3/4" NPT	4.12"	2.06"	5.50"	10.94"	---	2.81"	1.25"	1.12"	10.00"	0.56"	---	---	1.75"	2
FPV122R	Reg	3/4" NPT	(104.6)	(52.3)	(139.7)	(277.9)	---	(71.4)	(31.8)	(28.4)	(254.0)	(14.2)	---	---	(44.5)	
FPV123V	Vee	3/4" NPT	4.12"	2.06"	5.50"	10.94"	3.75"	2.81"	1.25"	1.12"	10.00"	0.56"	---	---	1.75"	3
FPV123R	Reg	3/4" NPT	(104.6)	(52.3)	(139.7)	(277.9)	(95.3)	(71.4)	(31.8)	(28.4)	(254.0)	(14.2)	---	---	(44.5)	
FPV124V	Vee	3/4" NPT	4.12"	2.06"	5.50"	10.94"	2.81"	2.81"	1.25"	1.12"	10.00"	0.56"	---	---	1.75"	4
FPV124R	Reg	3/4" NPT	(104.6)	(52.3)	(139.7)	(277.9)	(71.4)	(71.4)	(31.8)	(28.4)	(254.0)	(14.2)	---	---	(44.5)	
FPV125V	Vee	3/4" NPT	4.12"	2.06"	8.00"	18.88"	4.00"	2.81"	1.25"	1.12"	10.00"	0.56"	---	---	1.75"	5
FPV125R	Reg	3/4" NPT	(104.6)	(52.3)	(203.2)	(479.6)	(101.6)	(71.4)	(31.8)	(28.4)	(254.0)	(14.2)	---	---	(44.5)	
FPV126V	Vee	3/4" NPT	4.12"	2.06"	4.81"	10.25"	---	2.81"	1.25"	1.12"	10.00"	0.56"	1.75"	1.75"	1.75"	6
FPV126R	Reg	3/4" NPT	(104.6)	(52.3)	(122.2)	(260.4)	---	(71.4)	(31.8)	(28.4)	(254.0)	(14.2)	(44.5)	(44.5)	(44.5)	

See page NPT-1 for orifice and Cv

3-way One on Pressure

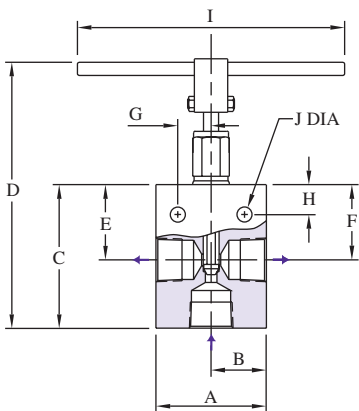

Figure 4

2-stem Manifold

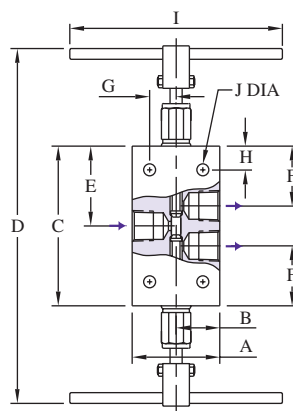

Figure 5

Replaceable Seat

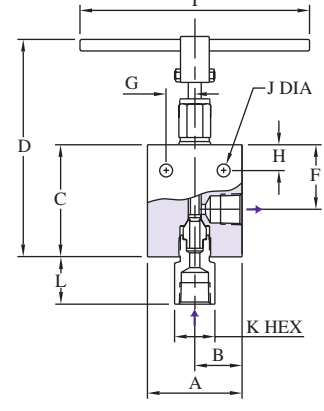

Figure 6

All dimensions are for reference only and are subject to change.
Dimensions in parentheses are millimeters (mm)

NEEDLE VALVES FOR 10,000 PSI (690 BAR)

3/4" PIPE

**2-way Straight
Female Ports**

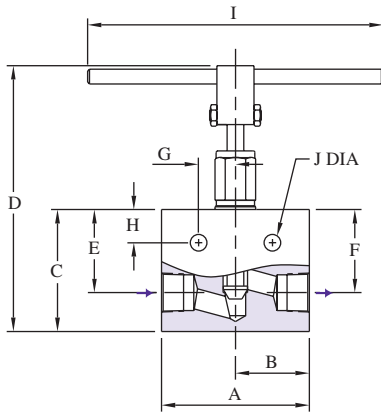

Figure 7

**2-way Straight
Male Inlet, Female Outlet**

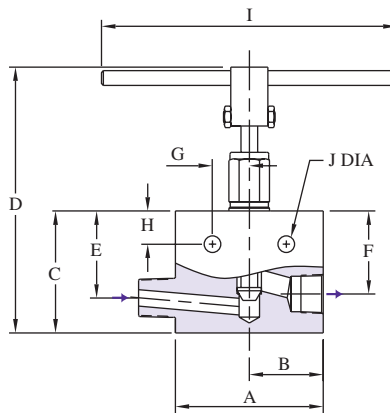

Figure 8

**2-way Angle
Male Inlet, Female Outlet**

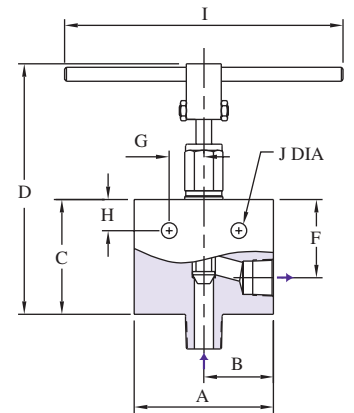

Figure 9

Catalog Number	Connection	A	B	C	D	E	F	G	H	I	J	Thk.	Fig
DHP12F	3/4" NPT	5.00" (127.0)	2.50" (63.5)	4.12" (104.6)	9.56" (242.8)	2.81" (71.4)	2.81" (71.4)	1.25" (31.8)	1.12" (28.4)	10.00" (254.0)	0.56" (14.2)	1.75" (44.5)	7
DHP12MF	3/4" NPT	6.00" (152.4)	2.50" (63.5)	4.12" (104.6)	9.56" (242.8)	2.81" (71.4)	2.81" (71.4)	1.25" (31.8)	1.12" (28.4)	10.00" (254.0)	0.56" (14.2)	1.75" (44.5)	8
DHP122MF	3/4" NPT	4.12" (104.6)	2.06" (52.3)	4.25" (108.0)	9.56" (242.8)	---	2.36" (59.9)	1.25" (31.8)	1.12" (28.4)	10.00" (254.0)	0.56" (14.2)	1.75" (44.5)	9

See page NPT-1 for orifice and Cv



All dimensions are for reference only and are subject to change.
Dimensions in parentheses are millimeters (mm)



NEEDLE VALVES FOR 10,000 PSI (690 BAR)

1" PIPE

2-way Straight

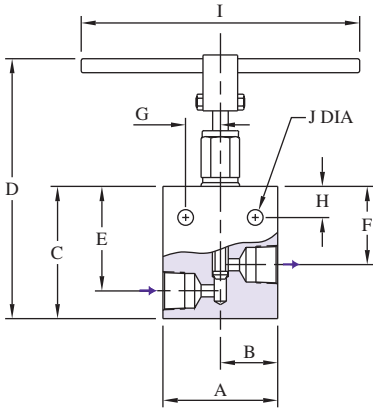

Figure 1

2-way Angle

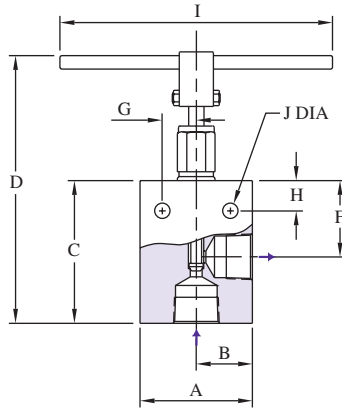

Figure 2

3-way Two on Pressure

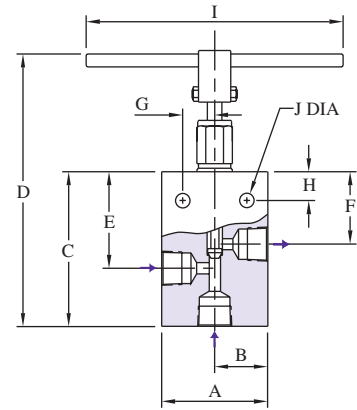

Figure 3

Catalog Number	Stem Style	Connection	A	B	C	D	E	F	G	H	I	J	K	L	Thk.	Fig
FPV161V	Vee	1" NPT	4.12"	2.06"	5.50"	10.94"	3.75"	2.81"	1.25"	1.12"	10.00"	0.56"	---	---	1.75"	1
FPV161R	Reg	1" NPT	(104.6)	(52.3)	(139.7)	(277.9)	(95.3)	(71.4)	(31.8)	(28.4)	(254.0)	(14.2)	---	---	(44.5)	
FPV162V	Vee	1" NPT	4.12"	2.06"	5.50"	10.94"	---	2.81"	1.25"	1.12"	10.00"	0.56"	---	---	1.75"	2
FPV162R	Reg	1" NPT	(104.6)	(52.3)	(139.7)	(277.9)	---	(71.4)	(31.8)	(28.4)	(254.0)	(14.2)	---	---	(44.5)	
FPV163V	Vee	1" NPT	4.12"	2.06"	5.75"	11.19"	3.75"	2.81"	1.25"	1.12"	10.00"	0.56"	---	---	1.75"	3
FPV163R	Reg	1" NPT	(104.6)	(52.3)	(146.1)	(284.2)	(95.3)	(71.4)	(31.8)	(28.4)	(254.0)	(14.2)	---	---	(44.5)	
FPV164V	Vee	1" NPT	4.12"	2.06"	5.50"	10.94"	2.81"	2.81"	1.25"	1.12"	10.00"	0.56"	---	---	1.75"	4
FPV164R	Reg	1" NPT	(104.6)	(52.3)	(139.7)	(277.9)	(71.4)	(71.4)	(31.8)	(28.4)	(254.0)	(14.2)	---	---	(44.5)	
FPV165V	Vee	1" NPT	4.12"	2.06"	8.00"	18.88"	4.00"	2.81"	1.25"	1.12"	10.00"	0.56"	---	---	1.75"	5
FPV165R	Reg	1" NPT	(104.6)	(52.3)	(203.2)	(479.6)	(101.6)	(71.4)	(31.8)	(28.4)	(254.0)	(14.2)	---	---	(44.5)	
FPV166V	Vee	1" NPT	4.12"	2.06"	5.50"	10.94"	---	2.81"	1.25"	1.12"	10.00"	0.56"	1.75"	2.08"	1.75"	6
FPV166R	Reg	1" NPT	(104.6)	(52.3)	(139.7)	(277.9)	---	(71.4)	(31.8)	(28.4)	(254.0)	(14.2)	(44.5)	(52.8)	(44.5)	

See page NPT-1 for orifice and Cv

3-way One on Pressure

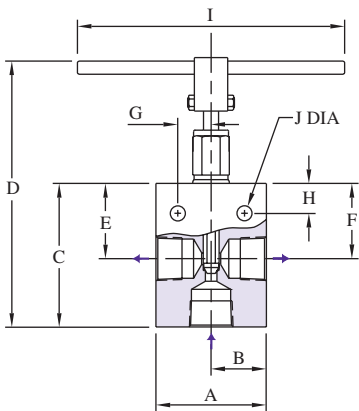

Figure 4

2-stem Manifold

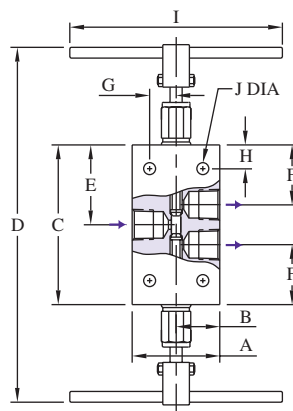

Figure 5

Replaceable Seat

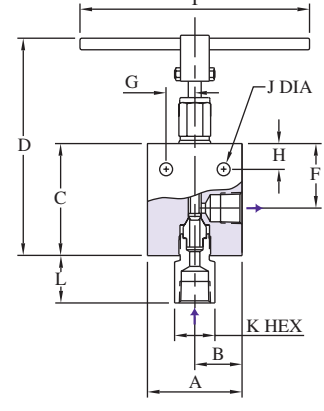

Figure 6

All dimensions are for reference only and are subject to change.
Dimensions in parentheses are millimeters (mm)

NEEDLE VALVES FOR 10,000 PSI (690 BAR)

1" PIPE

2-way Straight
Female Ports

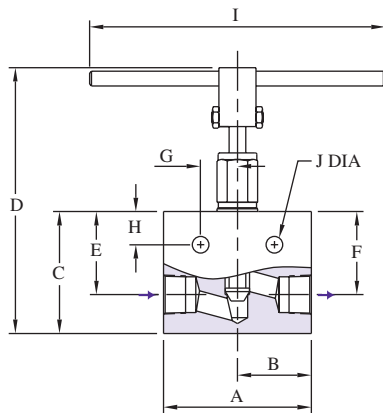

Figure8

2-way Straight
Male Inlet, Female Outlet

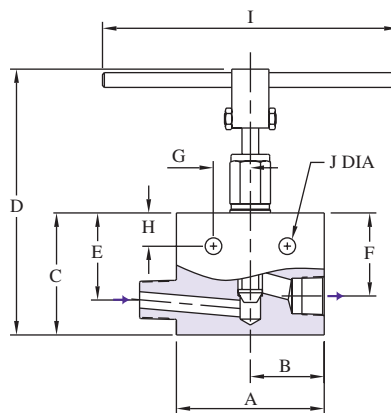

Figure 8

2-way Angle
Male Inlet, Female Outlet

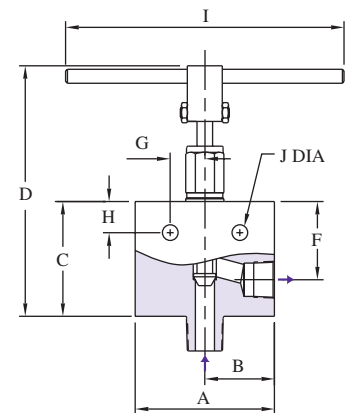

Figure9

Catalog Number	Connection	A	B	C	D	E	F	G	H	I	J	Thk.	Fig
DHP16F	1" NPT	5.00" (127.0)	2.50" (63.5)	4.12" (104.6)	9.56" (242.8)	2.81" (71.4)	2.81" (71.4)	1.25" (31.8)	1.12" (28.4)	10.00" (254.0)	0.56" (14.2)	1.75" (44.5)	7
DHP16MF	1" NPT	6.25" (158.8)	2.50" (63.5)	4.12" (104.6)	9.56" (242.8)	2.94" (74.7)	2.94" (74.7)	1.25" (31.8)	1.12" (28.4)	10.00" (254.0)	0.56" (14.2)	1.75" (44.5)	8
DHP162MF	1" NPT	4.12" (104.6)	2.06" (52.3)	4.50" (114.3)	9.94" (252.5)	---	2.36" (59.9)	1.25" (31.8)	1.12" (28.4)	10.00" (254.0)	0.56" (14.2)	1.75" (44.5)	9

See page NPT-1 for orifice and Cv

All dimensions are for reference only and are subject to change.
Dimensions in parentheses are millimeters (mm)



3- AND 5-STEM MANIFOLD VALVES

Three and Five-valve manifolds are used for applications requiring multiple ports for pressure testing and line sampling. BuTech can custom design manifolds to meet your specific requirements. Our manifolds are engineered with the same expertise, quality features and options found in all of our valves. For complete details, please consult the factory.

Features:

- Non-rotating stem prevents galling and scoring
 - Vee
 - Metering
 - Regulating
 - Micro-Metering
 - Soft Tip
- 17-4PH Stem for longer service life. 316 wetted parts are also available by specifying option **-316WP** (see page NPT-3)
- Low operating torque
- Pressures to 10,000 PSI (690 bar)
- 1/2" FNPT connections standard
- Standard body material: 316 stainless steel. Exotic materials available on request
- Available in Pipe-to-Pipe or Instrument Flange Mounting

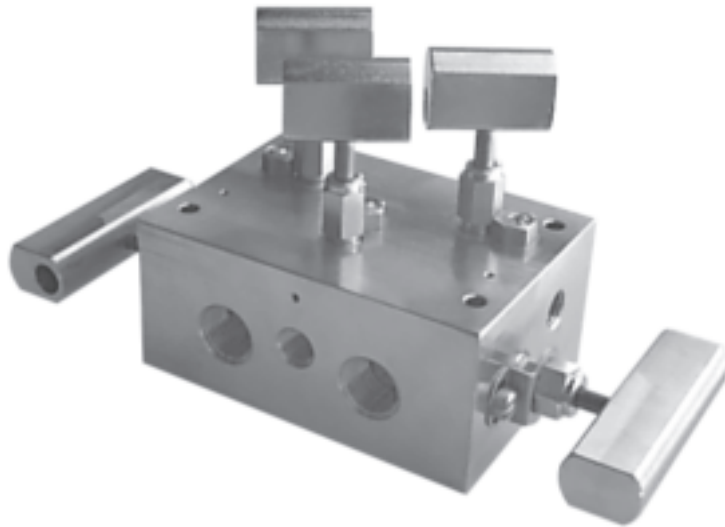

All dimensions are for reference only and are subject to change.
Dimensions in parentheses are millimeters (mm)

Page NPT-16

REPLACEABLE SEAT VALVES

Soft Seat

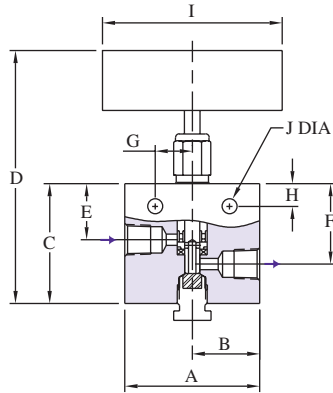

- Designed to permit replacement of the seat without removing the valve from the system.
- Non-rotating stem
- Shut-off and metering service capability
- Glass-filled Teflon Packing
- PEEK seat standard, Teflon, Torlon, Delrin, UHMWPE and other materials available

Catalog Number	Connection	A	B	C	D	E	F	G	H	I	J	Thk.
JSV-P2	1/8" NPT	2.25" (57.2)	1.12" (28.4)	2.00" (50.8)	4.34" (110.2)	0.94" (23.9)	1.34" (34.0)	0.62" (15.7)	0.38" (9.7)	3.00" (76.2)	0.25" (6.4)	0.75" (19.1)
JSV-P4	1/4" NPT	2.25" (57.2)	1.12" (28.4)	2.00" (50.8)	4.34" (110.2)	0.94" (23.9)	1.34" (34.0)	0.62" (15.7)	0.38" (9.7)	3.00" (76.2)	0.25" (6.4)	0.75" (19.1)
JSV-P6	3/8" NPT	2.25" (57.2)	1.12" (28.4)	2.00" (50.8)	4.34" (110.2)	0.94" (23.9)	1.34" (34.0)	0.62" (15.7)	0.38" (9.7)	3.00" (76.2)	0.25" (6.4)	1.00" (25.4)
JSV-P8	1/2" NPT	2.50" (63.5)	1.25" (31.8)	3.12" (79.2)	6.60" (167.6)	1.35" (34.3)	2.00" (50.8)	0.69" (17.5)	0.50" (12.7)	3.00" (76.2)	0.34" (8.6)	1.25" (31.8)

Ball Seat

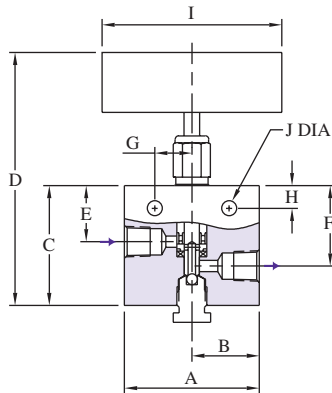

- Designed to permit replacement of the seat without removing the valve from the system
- Non-rotating stem
- Shut-off and metering service capability
- Glass-filled Teflon Packing
- 316SS seat standard, Stellite, Brass, and all other machineable materials available

Catalog Number	Connection	A	B	C	D	E	F	G	H	I	J	Thk.
JBV-P2	1/8" NPT	2.25" (57.2)	1.12" (28.4)	2.00" (50.8)	4.34" (110.2)	0.94" (23.9)	1.34" (34.0)	0.62" (15.7)	0.38" (9.7)	3.00" (76.2)	0.25" (6.4)	0.75" (19.1)
JBV-P4	1/4" NPT	2.25" (57.2)	1.12" (28.4)	2.00" (50.8)	4.34" (110.2)	0.94" (23.9)	1.34" (34.0)	0.62" (15.7)	0.38" (9.7)	3.00" (76.2)	0.25" (6.4)	0.75" (19.1)
JBV-P6	3/8" NPT	2.25" (57.2)	1.12" (28.4)	2.00" (50.8)	4.34" (110.2)	0.94" (23.9)	1.34" (34.0)	0.62" (15.7)	0.38" (9.7)	3.00" (76.2)	0.25" (6.4)	1.00" (25.4)
JBV-P8	1/2" NPT	2.50" (63.5)	1.25" (31.8)	3.12" (79.2)	6.62" (168.1)	1.35" (34.3)	2.00" (50.8)	0.69" (17.5)	0.50" (12.7)	3.00" (76.2)	0.34" (8.6)	1.25" (31.8)

All dimensions are for reference only and are subject to change.
Dimensions in parentheses are millimeters (mm)

PIPE ELBOWS

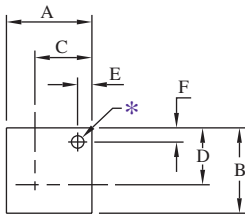

Female Elbow

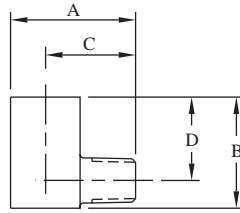

Street Elbow

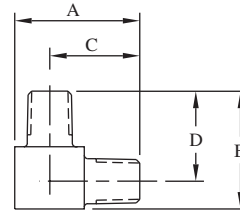

Male Elbow

FEMALE ELBOW

Catalog		Block							Mounting Holes*		
Number	Connection	Port	MAWP	A	B	C	D	Thickness	E	F	Dia.
FPL2	1/8" NPT	0.187" (4.7)	15,000 PSI 1030 bar	1.13" (28.7)	1.00" (25.4)	0.75" (19.1)	0.62" (15.7)	0.62" (15.7)	0.25" (6.4)	0.20" (5.1)	0.22" (5.6)
FPL4	1/4" NPT	0.250" (6.4)	15,000 PSI 1030 bar	1.50" (38.1)	1.25" (31.8)	1.00" (25.4)	0.81" (20.6)	0.75" (19.1)	0.38" (9.7)	0.25" (6.4)	0.22" (5.6)
FPL6	3/8" NPT	0.375" (9.5)	15,000 PSI 1030 bar	1.50" (38.1)	1.50" (38.1)	1.00" (25.4)	1.00" (25.4)	1.00" (25.4)	0.25" (6.4)	0.25" (6.4)	0.22" (5.6)
FPL8	1/2" NPT	0.500" (12.7)	15,000 PSI 1030 bar	1.75" (44.5)	1.75" (44.5)	1.25" (31.8)	1.25" (31.8)	1.25" (31.8)	0.37" (9.4)	0.37" (9.4)	0.28" (7.1)
FPL12	3/4" NPT	0.922" (23.4)	10,000 PSI 690 bar	2.62" (66.5)	2.12" (53.8)	1.31" (33.3)	1.38" (35.1)	1.50" (38.1)	N/A	N/A	N/A
FPL16	1" NPT	0.687" (17.4)	10,000 PSI 690 bar	3.00" (76.2)	2.56" (65.0)	1.69" (42.9)	1.69" (42.9)	1.75" (44.5)	0.50" (12.7)	0.50" (12.7)	0.22" (5.6)

*Mounting hole provided when the catalog number is suffixed by "-MH" when ordering.

STREET ELBOW

Catalog		Block						
Number	Connection	Port	MAWP	A	B	C	D	Thickness
MSPL2	1/8" NPT	0.187" (4.7)	15,000 PSI 1030 bar	1.12" (28.4)	1.00" (25.4)	0.81" (20.6)	0.75" (19.1)	0.62" (15.7)
MSPL4	1/4" NPT	0.250" (6.4)	15,000 PSI 1030 bar	1.50" (38.1)	1.50" (38.1)	1.13" (28.7)	1.00" (25.4)	1.00" (25.4)
MSPL6	3/8" NPT	0.375" (9.5)	15,000 PSI 1030 bar	1.75" (44.5)	1.50" (38.1)	1.25" (31.8)	1.00" (25.4)	1.00" (25.4)
MSPL8	1/2" NPT	0.500" (12.7)	15,000 PSI 1030 bar	2.25" (57.2)	2.00" (50.8)	1.63" (41.4)	1.25" (31.8)	1.25" (31.8)
MSPL12	3/4" NPT	0.625" (15.9)	10,000 PSI 690 bar	2.50" (63.5)	2.62" (66.5)	1.75" (44.5)	1.31" (33.3)	1.50" (38.1)
MSPL16	1" NPT	0.687" (17.4)	10,000 PSI 690 bar	3.00" (76.2)	2.88" (73.2)	2.12" (53.8)	1.68" (42.7)	1.75" (44.5)

MALE ELBOW

Catalog		Block						
Number	Connection	Port	MAWP	A	B	C	D	Thickness
MPL2	1/8" NPT	0.187" (4.7)	15,000 PSI 1030 bar	1.00" (25.4)	1.13" (28.7)	0.75" (19.1)	0.81" (20.6)	0.62" (15.7)
MPL4	1/4" NPT	0.250" (6.4)	15,000 PSI 1030 bar	1.50" (38.1)	1.50" (38.1)	1.13" (28.7)	1.13" (28.7)	0.75" (19.1)
MPL6	3/8" NPT	0.375" (9.5)	15,000 PSI 1030 bar	1.75" (44.5)	1.75" (44.5)	1.25" (31.8)	1.25" (31.8)	1.00" (25.4)
MPL8	1/2" NPT	0.500" (12.7)	15,000 PSI 1030 bar	2.00" (50.8)	2.00" (50.8)	1.50" (38.1)	1.50" (38.1)	1.00" (25.4)
MPL12	3/4" NPT	0.625" (15.9)	10,000 PSI 690 bar	2.62" (66.5)	2.62" (66.5)	1.75" (44.5)	1.75" (44.5)	1.50" (38.1)
MPL16	1" NPT	0.687" (17.4)	10,000 PSI 690 bar	3.00" (76.2)	3.00" (76.2)	2.13" (54.1)	2.13" (54.1)	1.75" (44.5)

All dimensions are for reference only and are subject to change.
Dimensions in parentheses are millimeters (mm)

PIPE TEES

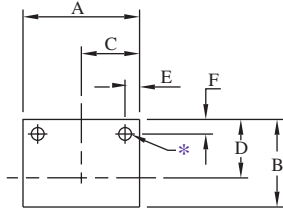

Female Tee

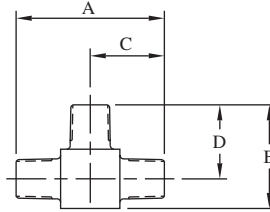

Male Tee

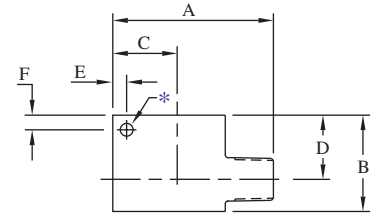

Male Street Tee

FEMALE TEES

Catalog Number	Connection	Port	MAWP	A	B	C	D	Block Thickness	Mounting Holes*		
									E	F	Dia.
FPT2	1/8" NPT	0.187" (4.7)	15,000 PSI 1030 bar	1.50" (38.1)	1.00" (25.4)	0.75" (19.1)	0.62" (15.7)	0.62" (15.7)	0.25" (6.4)	0.20" (5.1)	0.22" (5.6)
FPT4	1/4" NPT	0.437" (11.1)	15,000 PSI 1030 bar	2.00" (50.8)	1.25" (31.8)	1.00" (25.4)	0.81" (20.6)	0.75" (19.1)	0.38" (9.7)	0.25" (6.4)	0.22" (5.6)
FPT6	3/8" NPT	0.375" (9.5)	15,000 PSI 1030 bar	2.00" (50.8)	1.50" (38.1)	1.00" (25.4)	1.00" (25.4)	1.00" (25.4)	0.25" (6.4)	0.25" (6.4)	0.22" (5.6)
FPT8	1/2" NPT	0.500" (12.7)	15,000 PSI 1030 bar	2.50" (63.5)	1.75" (44.5)	1.25" (31.8)	1.25" (31.8)	1.25" (31.8)	0.38" (9.7)	0.38" (9.7)	0.28" (7.1)
FPT12	3/4" NPT	0.922" (23.4)	10,000 PSI 690 bar	2.62" (66.5)	2.12" (53.8)	1.31" (33.3)	1.38" (35.1)	1.50" (38.1)	N/A	N/A	N/A
FPT16	1" NPT	0.687" (17.4)	10,000 PSI 690 bar	3.38" (85.9)	2.56" (65.0)	1.69" (42.9)	1.69" (42.9)	1.75" (44.5)	0.50" (12.7)	0.50" (12.7)	0.22" (5.6)

MALE TEES

Catalog Number	Connection	Port	MAWP	A	B	C	D	Block Thickness
MPT2	1/8" NPT	0.187" (4.7)	15,000 PSI 1030 bar	1.50" (38.1)	1.13" (28.7)	0.75" (19.1)	0.81" (20.6)	0.62" (15.7)
MPT4	1/4" NPT	0.250" (6.4)	15,000 PSI 1030 bar	2.25" (57.2)	1.50" (38.1)	1.13" (28.7)	1.13" (28.7)	0.75" (19.1)
MPT6	3/8" NPT	0.375" (9.5)	15,000 PSI 1030 bar	2.50" (63.5)	1.75" (44.5)	1.25" (31.8)	1.25" (31.8)	1.00" (25.4)
MPT8	1/2" NPT	0.500" (12.7)	15,000 PSI 1030 bar	3.00" (76.2)	2.00" (50.8)	1.50" (38.1)	1.50" (38.1)	1.00" (25.4)
MPT12	3/4" NPT	0.625" (15.9)	10,000 PSI 690 bar	3.50" (88.9)	2.62" (66.5)	1.75" (44.5)	1.75" (44.5)	1.50" (38.1)
MPT16	1" NPT	0.687" (17.4)	10,000 PSI 690 bar	4.25" (108.0)	3.00" (76.2)	2.13" (54.1)	2.13" (54.1)	1.75" (44.5)

MALE STREET TEES

Catalog Number	Connection	Port	MAWP	A	B	C	D	Block Thickness	Mounting Holes*		
									E	F	Dia.
MSPT2	1/8" NPT	0.187" (4.7)	15,000 PSI 1030 bar	1.50" (38.1)	1.12" (28.4)	0.63" (16.0)	0.75" (19.1)	0.62" (15.7)	N/A	N/A	N/A
MSPT4	1/4" NPT	0.250" (6.4)	15,000 PSI 1030 bar	2.00" (50.8)	1.37" (34.8)	0.81" (20.6)	1.00" (25.4)	0.75" (19.1)	0.25" (6.4)	0.37" (9.4)	0.22" (5.6)
MSPT6	3/8" NPT	0.375" (9.5)	15,000 PSI 1030 bar	2.50" (63.5)	1.50" (38.1)	1.00" (25.4)	1.00" (25.4)	1.00" (25.4)	N/A	N/A	N/A
MSPT8	1/2" NPT	0.500" (12.7)	15,000 PSI 1030 bar	2.75" (69.9)	1.75" (44.5)	1.25" (31.8)	1.25" (31.8)	1.25" (31.8)	0.37" (9.4)	0.37" (9.4)	0.34" (8.6)
MSPT12	3/4" NPT	0.625" (15.9)	10,000 PSI 690 bar	3.12" (79.2)	2.62" (66.5)	1.38" (35.1)	1.31" (33.3)	1.50" (38.1)	0.37" (9.4)	0.37" (9.4)	0.34" (8.6)
MSPT16	1" NPT	0.687" (17.4)	10,000 PSI 690 bar	4.25" (108.0)	3.00" (76.2)	2.13" (54.1)	2.13" (54.1)	1.75" (44.5)	0.50" (12.7)	0.50" (12.7)	0.34" (8.6)

*Mounting holes provided when the catalog number is suffixed by "-MH" when ordering.

All dimensions are for reference only and are subject to change.
Dimensions in parentheses are millimeters (mm)



PIPE TEES, CROSSES AND BULKHEADS

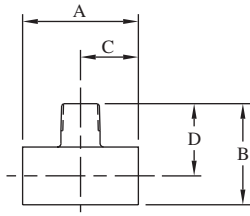

Male Branch Tee

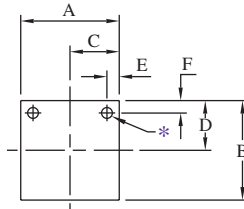

Female Cross

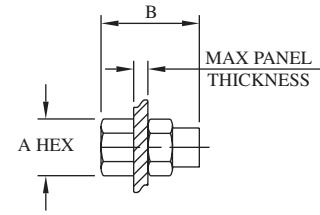

See bulkhead table below for panel hole drill size

MALE BRANCH TEES

Catalog Number	Connection	Port	MAWP	A	B	C	D	Block Thickness
MBPT2	1/8" NPT	0.187" (4.7)	15,000 PSI 1030 bar	1.50" (38.1)	1.13" (28.7)	0.75" (19.1)	0.81" (20.6)	0.62" (15.7)
MBPT4	1/4" NPT	0.250" (6.4)	15,000 PSI 1030 bar	2.00" (50.8)	1.50" (38.1)	1.00" (25.4)	1.13" (28.7)	1.00" (25.4)
MBPT6	3/8" NPT	0.375" (9.5)	15,000 PSI 1030 bar	2.00" (50.8)	1.75" (44.5)	1.00" (25.4)	1.25" (31.8)	1.00" (25.4)
MBPT8	1/2" NPT	0.500" (12.7)	15,000 PSI 1030 bar	2.50" (63.5)	2.25" (57.2)	1.25" (31.8)	1.63" (41.4)	1.25" (31.8)
MBPT12	3/4" NPT	0.625" (15.9)	10,000 PSI 690 bar	2.62" (66.5)	2.50" (63.5)	1.31" (33.3)	1.75" (44.5)	1.50" (38.1)
MBPT16	1" NPT	0.687" (17.4)	10,000 PSI 690 bar	3.37" (85.6)	3.00" (76.2)	1.69" (42.9)	2.13" (54.1)	1.75" (44.5)

FEMALE CROSSES

Catalog Number	Connection	Port	MAWP	A	B	C	D	Block Thickness	Mounting Holes*		
									E	F	Dia.
FPX2	1/8" NPT	0.187" (4.7)	15,000 PSI 1030 bar	1.50" (38.1)	1.50" (38.1)	0.75" (19.1)	0.75" (19.1)	0.62" (15.7)	0.25" (6.4)	0.25" (6.4)	0.22" (5.6)
FPX4	1/4" NPT	0.250" (6.4)	15,000 PSI 1030 bar	2.00" (50.8)	2.00" (50.8)	1.00" (25.4)	1.00" (25.4)	0.75" (19.1)	0.38" (9.7)	0.25" (6.4)	0.22" (5.6)
FPX6	3/8" NPT	0.375" (9.5)	15,000 PSI 1030 bar	2.00" (50.8)	2.00" (50.8)	1.00" (25.4)	1.00" (25.4)	1.00" (25.4)	0.25" (6.4)	0.25" (6.4)	0.22" (5.6)
FPX8	1/2" NPT	0.500" (12.7)	15,000 PSI 1030 bar	2.50" (63.5)	2.50" (63.5)	1.25" (31.8)	1.25" (31.8)	1.25" (31.8)	0.38" (9.7)	0.38" (9.7)	0.28" (7.1)
FPX12	3/4" NPT	0.922" (23.4)	10,000 PSI 690 bar	2.62" (66.5)	2.75" (69.9)	1.31" (33.3)	1.38" (35.1)	1.50" (38.1)	N/A	N/A	N/A
FPX16	1" NPT	0.687" (17.4)	10,000 PSI 690 bar	4.12" (104.6)	4.12" (104.6)	2.06" (52.3)	2.06" (52.3)	1.75" (44.5)	N/A	N/A	N/A

*Mounting holes provided when the catalog number is suffixed by "-MH" when ordering.

BULKHEADS

Catalog Number	Connection	Port	MAWP	A	B	Panel Hole	Panel Thickness
FPBF2	1/8" NPT	0.339" (8.6)	15,000 PSI 1030 bar	1.00" (25.4)	2.00" (50.8)	0.81" (20.6)	0.38" (9.7)
FPBF4	1/4" NPT	0.437" (11.1)	15,000 PSI 1030 bar	1.00" (25.4)	2.00" (50.8)	0.94" (23.9)	0.38" (9.7)
FPBF6	3/8" NPT	0.578" (14.7)	15,000 PSI 1030 bar	1.37" (34.8)	2.62" (66.5)	1.25" (31.8)	0.50" (12.7)
FPBF8	1/2" NPT	0.703" (17.9)	15,000 PSI 1030 bar	1.50" (38.1)	2.62" (66.5)	1.37" (34.8)	0.50" (12.7)
FPBF12	3/4" NPT	0.625" (15.9)	10,000 PSI 690 bar	1.88" (47.8)	2.62" (66.5)	1.69" (42.9)	0.50" (12.7)
FPBF16	1" NPT	0.687" (17.4)	10,000 PSI 690 bar	2.12" (53.8)	3.50" (88.9)	1.94" (49.3)	0.50" (12.7)

All dimensions are for reference only and are subject to change.
Dimensions in parentheses are millimeters (mm)

PIPE ADAPTERS

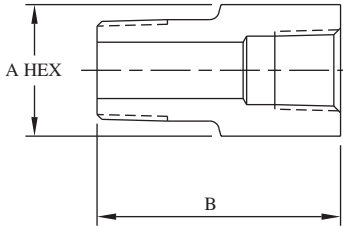

Catalog Number	Male NPT	Female NPT	Port	MAWP	A	B
10A2P4P	1/8"	1/4"	0.187" (4.7)	15,000 PSI 1030 bar	0.75" (19.1)	1.38" (35.1)
10A2P6P	1/8"	3/8"	0.187" (4.7)	15,000 PSI 1030 bar	1.00" (25.4)	1.56" (39.6)
10A2P8P	1/8"	1/2"	0.187" (4.7)	15,000 PSI 1030 bar	1.38" (35.1)	1.56" (39.6)
10A2P12P	1/8"	3/4"	0.187" (4.7)	10,000 PSI 690 bar	1.38" (35.1)	2.12" (53.8)
10A2P16P	1/8"	1"	0.187" (4.7)	10,000 PSI 690 bar	1.75" (44.5)	2.25" (57.2)
10A4P2P	1/4"	1/8"	0.187" (4.7)	15,000 PSI 1030 bar	0.75" (19.1)	1.50" (38.1)
10A4P6P	1/4"	3/8"	0.250" (6.4)	15,000 PSI 1030 bar	0.88" (22.4)	1.75" (44.5)
10A4P8P	1/4"	1/2"	0.250" (6.4)	15,000 PSI 1030 bar	1.38" (35.1)	1.75" (44.5)
10A4P12P	1/4"	3/4"	0.250" (6.4)	10,000 PSI 690 bar	1.38" (35.1)	2.25" (57.2)
10A4P16P	1/4"	1"	0.250" (6.4)	10,000 PSI 690 bar	1.75" (44.5)	2.38" (60.5)
10A6P2P	3/8"	1/8"	0.339" (8.6)	15,000 PSI 1030 bar	0.88" (22.4)	1.50" (38.1)
10A6P4P	3/8"	1/4"	0.375" (9.5)	15,000 PSI 1030 bar	0.88" (22.4)	1.62" (41.1)
10A6P8P	3/8"	1/2"	0.375" (9.5)	15,000 PSI 1030 bar	1.38" (35.1)	2.00" (50.8)
10A6P12P	3/8"	3/4"	0.375" (9.5)	10,000 PSI 690 bar	1.38" (35.1)	2.00" (50.8)
10A6P16P	3/8"	1"	0.375" (9.5)	10,000 PSI 690 bar	1.75" (44.5)	2.56" (65.0)

Catalog Number	Male NPT	Female NPT	Port	MAWP	A	B
10A8P2P	1/2"	1/8"	0.339" (8.6)	15,000 PSI 1030 bar	1.00" (25.4)	1.75" (44.5)
10A8P4P	1/2"	1/4"	0.250" (6.4)	15,000 PSI 1030 bar	1.00" (25.4)	1.81" (46.0)
10A8P6P	1/2"	3/8"	0.500" (12.7)	15,000 PSI 1030 bar	1.00" (25.4)	2.00" (50.8)
10A8P12P	1/2"	3/4"	0.500" (12.7)	10,000 PSI 690 bar	1.38" (35.1)	2.50" (63.5)
10A8P16P	1/2"	1"	0.500" (12.7)	10,000 PSI 690 bar	1.75" (44.5)	2.25" (57.2)
10A12P2P	3/4"	1/8"	0.339" (8.6)	10,000 PSI 690 bar	1.13" (28.7)	1.51" (38.4)
10A12P4P	3/4"	1/4"	0.437" (11.1)	10,000 PSI 690 bar	1.13" (28.7)	1.51" (38.4)
10A12P6P	3/4"	3/8"	0.578" (14.7)	10,000 PSI 690 bar	1.13" (28.7)	2.00" (50.8)
10A12P8P	3/4"	1/2"	0.625" (15.9)	10,000 PSI 690 bar	1.38" (35.1)	2.00" (50.8)
10A12P16P	3/4"	1"	0.625" (15.9)	10,000 PSI 690 bar	1.75" (44.5)	2.56" (65.0)
10A16P2P	1"	1/8"	0.339" (8.6)	10,000 PSI 690 bar	1.38" (35.1)	2.00" (50.8)
10A16P4P	1"	1/4"	0.250" (6.4)	10,000 PSI 690 bar	1.38" (35.1)	1.88" (47.8)
10A16P6P	1"	3/8"	0.578" (14.7)	10,000 PSI 690 bar	1.38" (35.1)	2.25" (57.2)
10A16P8P	1"	1/2"	0.500" (12.7)	10,000 PSI 690 bar	1.38" (35.1)	2.37" (60.2)
10A16P12P	1"	3/4"	0.625" (15.9)	10,000 PSI 690 bar	1.38" (35.1)	2.75" (69.9)

All dimensions are for reference only and are subject to change.
Dimensions in parentheses are millimeters (mm)



PIPE COUPLINGS

COUPLINGS

Catalog					
Number	Connection	Port	MAWP	A	B
FPF2	1/8" NPT	0.339" (8.6)	15,000 PSI 1030 bar	0.63" (16.0)	1.00" (25.4)
FPF4	1/4" NPT	0.437" (11.1)	15,000 PSI 1030 bar	0.75" (19.1)	1.25" (31.8)
FPF6	3/8" NPT	0.578" (14.7)	15,000 PSI 1030 bar	1.00" (25.4)	1.38" (35.1)
FPF8	1/2" NPT	0.703" (17.9)	15,000 PSI 1030 bar	1.38" (35.1)	1.50" (38.1)
FPF12	3/4" NPT	0.922" (23.4)	10,000 PSI 690 bar	1.38" (35.1)	1.75" (44.5)
FPF16	1" NPT	1.156" (29.4)	10,000 PSI 690 bar	1.75" (44.5)	2.18" (55.4)

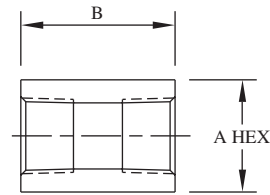

REDUCER COUPLINGS

Catalog						
Number	End 1	End 2	Port	MAWP	A	B
10F2P4P	1/8" FNPT	1/4" FNPT	0.339" (8.6)	15,000 PSI 1030 bar	0.75" (19.1)	1.25" (31.8)
10F2P6P	1/8" FNPT	3/8" FNPT	0.339" (8.6)	15,000 PSI 1030 bar	1.00" (25.4)	1.38" (35.1)
10F2P8P	1/8" FNPT	1/2" FNPT	0.339" (8.6)	15,000 PSI 1030 bar	1.38" (31.8)	1.50" (38.1)
10F2P12P	1/8" FNPT	3/4" FNPT	0.339" (8.6)	10,000 PSI 690 bar	1.38" (35.1)	1.62" (41.1)
10F2P16P	1/8" FNPT	1" FNPT	0.339" (8.6)	10,000 PSI 690 bar	1.75" (44.5)	2.00" (50.8)
10F4P6P	1/4" FNPT	3/8" FNPT	0.437" (11.1)	15,000 PSI 1030 bar	1.00" (25.4)	1.38" (35.1)
10F4P8P	1/4" FNPT	1/2" FNPT	0.437" (11.1)	15,000 PSI 1030 bar	1.38" (35.1)	1.62" (41.1)
10F4P12P	1/4" FNPT	3/4" FNPT	0.374" (11.1)	10,000 PSI 690 bar	1.38" (35.1)	1.75" (44.5)
10F4P16P	1/4" FNPT	1" FNPT	0.437" (11.1)	10,000 PSI 690 bar	1.75" (44.5)	2.00" (50.8)
10F6P8P	3/8" FNPT	1/2" FNPT	0.578" (14.7)	15,000 PSI 1030 bar	1.38" (35.1)	1.63" (41.4)
10F6P12P	3/8" FNPT	3/4" FNPT	0.578" (14.7)	10,000 PSI 690 bar	1.38" (35.1)	1.75" (44.5)
10F6P16P	3/8" FNPT	1" FNPT	0.578" (14.7)	10,000 PSI 690 bar	1.75" (44.5)	2.00" (50.8)
10F8P12P	1/2" FNPT	3/4" FNPT	0.703" (17.9)	10,000 PSI 690 bar	1.38" (35.1)	1.75" (44.5)
10F8P16P	1/2" FNPT	1" FNPT	0.703" (17.9)	10,000 PSI 690 bar	1.75" (44.5)	2.19" (55.6)
10F12P16P	3/4" FNPT	1" FNPT	0.922" (23.4)	10,000 PSI 690 bar	1.75" (44.5)	2.18" (55.4)

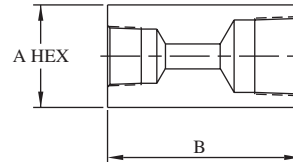

All dimensions are for reference only and are subject to change.
Dimensions in parentheses are millimeters (mm)

PIPE ACCESSORIES

ZERO-CLEARANCE UNIONS

Catalog						
Number	Connection	Port	MAWP	A	B	C
FPUF2	1/8" NPT	0.339" (8.6)	15,000 PSI 1030 bar	1.50" (38.1)	2.38" (60.5)	0.62" (15.7)
FPUF4	1/4" NPT	0.437" (11.1)	15,000 PSI 1030 bar	1.75" (44.5)	2.56" (65.0)	0.75" (19.1)
FPUF6	3/8" NPT	0.578" (14.7)	15,000 PSI 1030 bar	1.87" (47.5)	2.83" (71.9)	0.87" (22.1)
FPUF8	1/2" NPT	0.703" (17.9)	15,000 PSI 1030 bar	1.87" (47.5)	2.83" (71.9)	1.00" (25.4)
FPUF12	3/4" NPT	0.921" (23.4)	10,000 PSI 690 bar	2.12" (53.8)	3.12" (79.2)	1.38" (35.1)

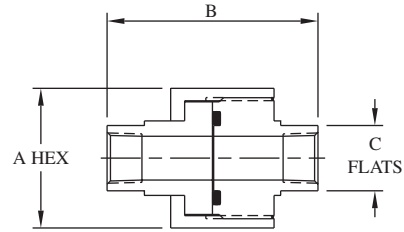

PLUGS

Catalog				
Number	Connection	MAWP	A	B
MPP2	1/8" NPT	15,000 PSI 1030 bar	0.50" (12.7)	1.00" (25.4)
MPP4	1/4" NPT	15,000 PSI 1030 bar	0.63" (16.0)	1.12" (28.4)
MPP6	3/8" NPT	15,000 PSI 1030 bar	0.75" (19.1)	1.12" (28.4)
MPP8	1/2" NPT	15,000 PSI 1030 bar	1.00" (25.4)	1.50" (38.1)
MPP12	3/4" NPT	10,000 PSI 690 bar	1.38" (35.1)	1.50" (38.1)
MPP16	1" NPT	10,000 PSI 690 bar	1.38" (35.1)	1.88" (47.8)

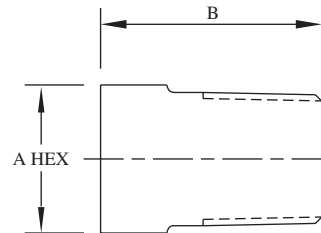

CAPS

Catalog				
Number	Connection	MAWP	A	B
FPCA2	1/8" NPT	15,000 PSI 1030 bar	0.63" (16.0)	0.75" (19.1)
FPCA4	1/4" NPT	15,000 PSI 1030 bar	0.75" (19.1)	1.00" (25.4)
FPCA6	3/8" NPT	15,000 PSI 1030 bar	1.00" (25.4)	1.00" (25.4)
FPCA8	1/2" NPT	15,000 PSI 1030 bar	1.38" (35.1)	1.25" (31.8)
FPCA12	3/4" NPT	10,000 PSI 690 bar	1.38" (35.1)	1.50" (38.1)
FPCA16	1" NPT	10,000 PSI 690 bar	1.75" (44.5)	1.68" (42.7)

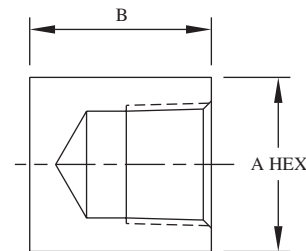

All dimensions are for reference only and are subject to change.
Dimensions in parentheses are millimeters (mm)

PIPE NIPPLES

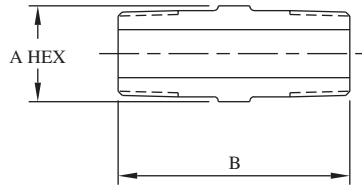

Catalog Number	End 1	End 2	Port	MAWP	A	B
MA2P2P	1/8" MNPT	1/8" MNPT	0.125" (3.2)	15,000 PSI 1030 bar	0.50" (12.7)	1.38" (35.1)
MA2P2P4	1/8" MNPT	1/8" MNPT	0.125" (3.2)	15,000 PSI 1030 bar	0.50" (12.7)	4.00" (101.6)
MA4P2P	1/4" MNPT	1/8" MNPT	0.187" (4.7)	15,000 PSI 1030 bar	0.63" (16.0)	1.62" (41.1)
MA4P4P	1/4" MNPT	1/4" MNPT	0.250" (6.4)	15,000 PSI 1030 bar	0.63" (16.0)	1.75" (44.5)
MA4P4P2	1/4" MNPT	1/4" MNPT	0.250" (6.4)	15,000 PSI 1030 bar	0.63" (16.0)	2.00" (50.8)
MA4P4P3	1/4" MNPT	1/4" MNPT	0.250" (6.4)	15,000 PSI 1030 bar	0.63" (16.0)	3.00" (76.2)
MA4P4P4	1/4" MNPT	1/4" MNPT	0.250" (6.4)	15,000 PSI 1030 bar	0.63" (16.0)	4.00" (101.6)
MA4P4P6	1/4" MNPT	1/4" MNPT	0.250" (6.4)	15,000 PSI 1030 bar	0.63" (16.0)	6.00" (152.4)
MA6P2P	3/8" MNPT	1/8" MNPT	0.187" (4.7)	15,000 PSI 1030 bar	0.75" (19.1)	1.62" (41.1)
MA6P4P	3/8" MNPT	1/4" MNPT	0.250" (6.4)	15,000 PSI 1030 bar	0.75" (19.1)	1.81" (46.0)
MA6P6P	3/8" MNPT	3/8" MNPT	0.375" (9.5)	15,000 PSI 1030 bar	0.75" (19.1)	1.81" (46.0)
MA6P6P3	3/8" MNPT	3/8" MNPT	0.375" (9.5)	15,000 PSI 1030 bar	0.75" (19.1)	3.00" (76.2)
MA8P2P	1/2" MNPT	1/8" MNPT	0.187" (4.7)	15,000 PSI 1030 bar	1.00" (25.4)	1.94" (49.3)
MA8P4P	1/2" MNPT	1/4" MNPT	0.250" (6.4)	15,000 PSI 1030 bar	1.00" (25.4)	2.12" (53.8)
MA8P6P	1/2" MNPT	3/8" MNPT	0.375" (9.5)	15,000 PSI 1030 bar	1.00" (25.4)	2.12" (53.8)
MA8P8P	1/2" MNPT	1/2" MNPT	0.500" (12.7)	15,000 PSI 1030 bar	1.00" (25.4)	2.50" (63.5)
MA8P8P4	1/2" MNPT	1/2" MNPT	0.500" (12.7)	15,000 PSI 1030 bar	1.00" (25.4)	4.00" (101.6)
MA8P8P6	1/2" MNPT	1/2" MNPT	0.500" (12.7)	15,000 PSI 1030 bar	1.00" (25.4)	6.00" (152.4)

Catalog Number	End 1	End 2	Port	MAWP	A	B
MA12P2P	3/4" MNPT	1/8" MNPT	0.187" (4.7)	10,000 PSI 690 bar	1.13" (28.7)	2.00" (50.8)
MA12P4P	3/4" MNPT	1/4" MNPT	0.250" (6.4)	10,000 PSI 690 bar	1.13" (28.7)	2.25" (57.2)
MA12P6P	3/4" MNPT	3/8" MNPT	0.375" (9.5)	10,000 PSI 690 bar	1.13" (28.7)	2.25" (57.2)
MA12P8P	3/4" MNPT	1/2" MNPT	0.500" (12.7)	10,000 PSI 690 bar	1.18" (30.0)	2.50" (63.5)
MA12P8P4	3/4" MNPT	1/2" MNPT	0.500" (12.7)	10,000 PSI 690 bar	1.18" (30.0)	4.00" (101.6)
MA12P12P2	3/4" MNPT	3/4" MNPT	0.625" (15.9)	10,000 PSI 690 bar	1.13" (28.7)	2.00" (50.8)
MA12P12P6	3/4" MNPT	3/4" MNPT	0.625" (15.9)	10,000 PSI 690 bar	1.13" (28.7)	6.00" (152.4)
MA16P2P	1" MNPT	1/8" MNPT	0.187" (4.7)	10,000 PSI 690 bar	1.38" (35.1)	2.25" (57.2)
MA16P4P	1" MNPT	1/4" MNPT	0.250" (6.4)	10,000 PSI 690 bar	1.38" (35.1)	2.50" (63.5)
MA16P6P	1" MNPT	3/8" MNPT	0.375" (9.5)	10,000 PSI 690 bar	1.38" (35.1)	2.50" (63.5)
MA16P8P	1" MNPT	1/2" MNPT	0.500" (12.7)	10,000 PSI 690 bar	1.38" (35.1)	2.75" (69.9)
MA16P12P	1" MNPT	3/4" MNPT	0.625" (15.9)	10,000 PSI 690 bar	1.38" (35.1)	2.75" (69.9)
MA16P16P	1" MNPT	1" MNPT	0.687" (17.4)	10,000 PSI 690 bar	1.38" (35.1)	3.00" (76.2)

All dimensions are for reference only and are subject to change.
Dimensions in parentheses are millimeters (mm)

PIPE CHECK VALVES

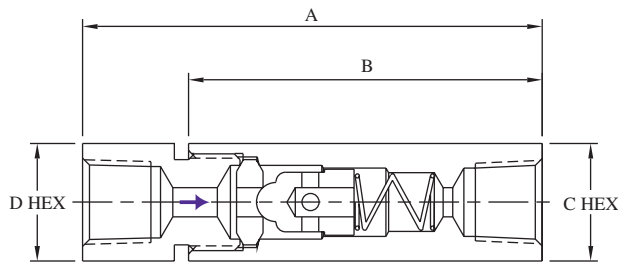

BuTech ball check valves prevent reverse flow where leak-tight shutoff is not necessary. Standard materials of construction are 316 stainless steel with 17-4PH poppet for longer life, and 300 series stainless steel spring.

Note: For 316 stainless steel wetted parts, add **-316WP** to the catalog number.

Cracking pressure: 15 PSI (1 bar) approximate
 Operating Temperature Range:
 -420° to +1200°F
 (-251° to +648°C)

BALL CHECK VALVES

Catalog Number	Connection	MAWP	Cv	A	B	C	D
FPBC2	1/8" NPT	15,000 PSI 1030 bar	0.15	2.62" (66.5)	2.12" (53.8)	0.63" (16.0)	0.50" (12.7)
FPBC4	1/4" NPT	15,000 PSI 1030 bar	0.63	2.94" (74.7)	2.26" (57.4)	0.75" (19.1)	0.75" (19.1)
FPBC6	3/8" NPT	15,000 PSI 1030 bar	0.80	3.54" (89.9)	2.62" (66.5)	1.12" (28.4)	1.00" (25.4)
FPBC8	1/2" NPT	15,000 PSI 1030 bar	2.30	4.32" (109.7)	3.50" (88.9)	1.38" (35.1)	1.38" (35.1)
FPBC12	3/4" NPT	10,000 PSI 690 bar	3.40	5.89" (149.6)	4.75" (120.7)	1.75" (44.5)	1.50" (38.1)
FPBC16	1" NPT	10,000 PSI 690 bar	5.20	7.29" (185.2)	5.75" (146.1)	2.12" (53.8)	1.75" (44.5)

To order a valve with a cracking pressure other than the standard 15 PSI, add the cracking pressure to the end of the catalog number. Example: An FPBC8 with 50 PSI cracking pressure would be ordered as **FPBC8-50**.

Cracking pressures available up to 100 PSI (7 bar)

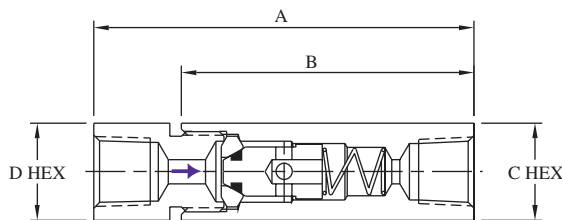

BuTech o-ring check valves reliably prevent backflow where leak-tight shutoff for liquids or gases is required. Standard materials of construction are 316 stainless steel with Buna-N o-ring and 300 series stainless steel spring.

Cracking pressure: 15 PSI (1 bar) approximate
 Operating Temperature Ranges:

O-ring Material	Operating Temperature Range	Catalog Suffix
Buna-N	-65° to +250°F (-54° to +121°C)	----
Viton	-40° to +500°F (-40° to +260°C)	-VA
Teflon	-320° to +400°F (-195° to +204°C)	-TFE
Kalrez	-20° to +550°F (-29° to +288°C)	-HT

O-RING CHECK VALVES

Catalog Number	Connection	MAWP	Cv	A	B	C	D
FPSC2	1/8" NPT	15,000 PSI 1030 bar	0.15	2.62" (66.5)	2.12" (53.8)	0.63" (16.0)	0.50" (12.7)
FPSC4	1/4" NPT	15,000 PSI 1030 bar	0.63	2.94" (74.7)	2.26" (57.4)	0.75" (19.1)	0.75" (19.1)
FPSC6	3/8" NPT	15,000 PSI 1030 bar	0.80	3.54" (89.9)	2.62" (66.5)	1.12" (28.4)	1.00" (25.4)
FPSC8	1/2" NPT	15,000 PSI 1030 bar	2.30	4.32" (109.7)	3.50" (88.9)	1.38" (35.1)	1.38" (35.1)
FPSC12	3/4" NPT	10,000 PSI 690 bar	3.40	5.89" (149.6)	4.75" (120.7)	1.75" (44.5)	1.50" (38.1)
FPSC16	1" NPT	10,000 PSI 690 bar	5.20	7.29" (185.2)	5.75" (146.1)	2.12" (53.8)	1.75" (44.5)

To order a valve with a cracking pressure other than the standard 15 PSI, add the cracking pressure to the end of the catalog number. Example: A FPSC4 with 40 PSI cracking pressure would be ordered as **FPSC4-40**.

Cracking pressures available up to 100 PSI (7 bar)



All dimensions are for reference only and are subject to change.
 Dimensions in parentheses are millimeters (mm)



TWIN SEAL CHECK VALVES

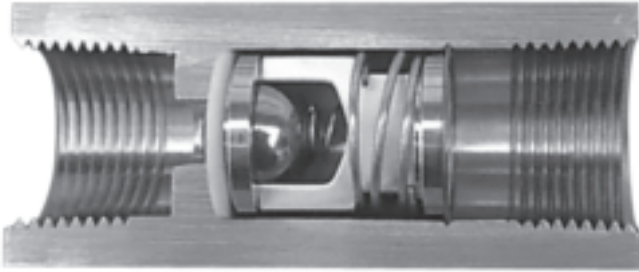

When a BuTech Twin-Seal check valve initially closes, the ball seals on the teflon seat. As the teflon begins to deflect under pressure, the ball contacts the metal seat. This creates a metal-to-metal seal, relieving the teflon of the full pressure load. Standard materials of construction are 316 stainless steel with 300 series stainless steel spring. Note: For 316 stainless steel wetted parts, add **-316WP** to the catalog number. Other seat materials are available, please consult factory.

Cracking pressure: 15 PSI (1 bar) approximate
 Operating Temperature Range:
 -320° to +400°F
 (-195° to +204°C)

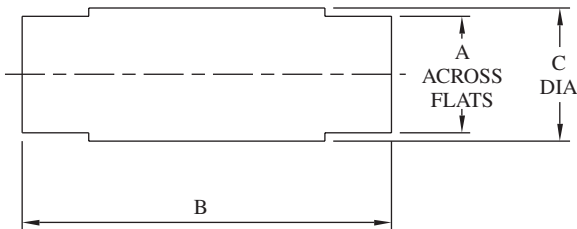

FPSSC4

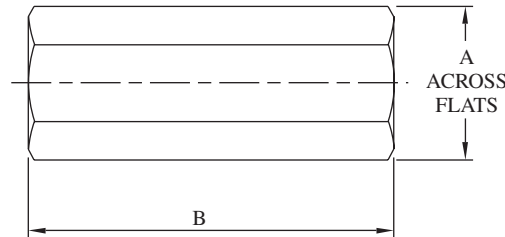

FPSSC6 through FPSSC16

Catalog Number	Connection	MAWP	Cv	A	B	C
FPSSC4	1/4" NPT	15,000 PSI 1030 bar	1.25	0.88" (22.4)	3.00" (76.2)	1.00" (25.4)
FPSSC6	3/8" NPT	15,000 PSI 1030 bar	1.25	1.00" (25.4)	2.75" (69.9)	—
FPSSC8	1/2" NPT	15,000 PSI 1030 bar	2.16	1.18" (30.0)	3.12" (79.2)	—
FPSSC12	3/4" NPT	10,000 PSI 690 bar	4.00	1.38" (35.1)	3.25" (82.6)	—
FPSSC16	1" NPT	9,000 PSI 620 bar	5.00	1.75" (44.5)	4.25" (108.0)	—

To order a valve with a cracking pressure other than the standard 15 PSI, add the cracking pressure to the end of the catalog number. Example: A FPSSC4 with 50 PSI cracking pressure would be ordered as **FPSSC4-50**.

Cracking pressures available up to 100 PSI (7 bar)

All dimensions are for reference only and are subject to change.
 Dimensions in parentheses are millimeters (mm)

PIPE FILTERS

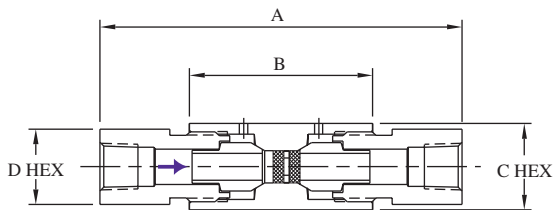

BuTech line filters are used in system lines to remove contaminating particles from the system fluid. Upstream filter of larger micron rating than downstream filter to prevent clogging of downstream filter.

Standard materials of construction are 316 stainless steel with 300 series stainless steel filter discs. Available in nominal ratings of: 0.5, 2, 5, 10, 20, 40, and 100 micron.

LINE FILTERS

Catalog Number	Connection	MAWP	Area*	A	B	C	D
FPLF2	1/8" NPT	15,000 PSI 1030 bar	0.06 in ² 39 mm ²	3.62" (91.9)	1.75" (44.5)	0.75" (19.1)	0.63" (16.0)
FPLF4	1/4" NPT	15,000 PSI 1030 bar	0.15 in ² 97 mm ²	4.19" (106.4)	2.12" (53.8)	0.88" (22.4)	1.00" (25.4)
FPLF6	3/8" NPT	15,000 PSI 1030 bar	0.15 in ² 97 mm ²	5.20" (132.1)	2.12" (53.8)	1.00" (25.4)	1.00" (25.4)
FPLF8	1/2" NPT	15,000 PSI 1030 bar	0.30 in ² 194 mm ²	5.80" (147.3)	2.50" (63.5)	1.38" (35.1)	1.38" (35.1)
FPLF12	3/4" NPT	10,000 PSI 690 bar	0.50 in ² 323 mm ²	6.67" (169.4)	3.50" (88.9)	1.75" (44.5)	1.75" (44.5)
FPLF16	1" NPT	10,000 PSI 690 bar	0.50 in ² 323 mm ²	7.17" (182.1)	3.50" (88.9)	1.75" (44.5)	2.12" (53.8)

*Effective area of filter element

Micron rating of filter must be specified. To order, complete the catalog number with the desired micron rating, upstream first:

FPLF4-40/20

specifies a line filter with 1/4" NPT connections, a 40 micron filter upstream and 20 micron downstream.

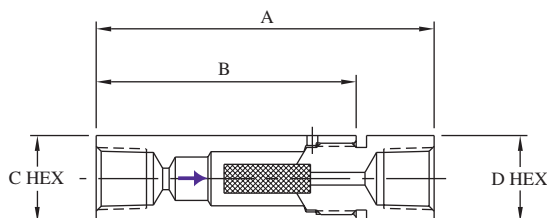

BuTech sintered cup filters offer maximum filtration surface area for removal of contaminating particles from the fluid system. They may be used in systems which require high flow rates with minimum pressure drop.

Standard materials of construction are 316 stainless steel with 300 series stainless steel filter discs. Available in nominal ratings of: 5, 10, 20, 40, and 100 micron.

SINTERED CUP FILTERS

Catalog Number	Connection	MAWP	Area*	A	B	C	D
FPSCF2	1/8" NPT	15,000 PSI 1030 bar	0.54 in ² 348 mm ²	2.62" (66.5)	2.12" (53.8)	0.62" (15.7)	0.62" (15.7)
FPSCF4	1/4" NPT	15,000 PSI 1030 bar	0.54 in ² 348 mm ²	2.94" (74.7)	2.26" (57.4)	0.75" (19.1)	0.75" (19.1)
FPSCF6	3/8" NPT	15,000 PSI 1030 bar	1.47 in ² 948 mm ²	3.44" (87.4)	2.62" (66.5)	1.12" (28.4)	1.12" (28.4)
FPSCF8	1/2" NPT	15,000 PSI 1030 bar	1.47 in ² 948 mm ²	4.23" (107.4)	3.50" (88.9)	1.38" (35.1)	1.38" (35.1)
FPSCF12	3/4" NPT	10,000 PSI 690 bar	1.75 in ² 1129 mm ²	5.94" (150.9)	4.75" (120.7)	1.75" (44.5)	1.75" (44.5)
FPSCF16	1" NPT	10,000 PSI 690 bar	4.60 in ² 2968 mm ²	8.09" (205.5)	5.75" (146.1)	2.12" (53.8)	2.12" (53.8)

*Effective area of filter element

Micron rating of filter must be specified. To order, complete the catalog number with the desired micron rating:

FPSCF4-20

specifies a line filter with 1/4" NPT connections and a 20 micron filter.

All dimensions are for reference only and are subject to change.
Dimensions in parentheses are millimeters (mm)



PIPE SAFETY HEADS & RUPTURE DISCS

BuTech safety head assemblies serve as holders for standard rupture discs (sold separately). Safety heads with rupture discs are used as simple and inexpensive overpressure relief devices. System pressure is relieved as a result of rupture of the replaceable disc.

The safety head assemblies shown are designed for use in high pressure systems up to 15,000 PSI (1030 bar). They can be installed directly into any of our standard couplings, elbows, tees, or crosses. Their versatility also allows direct installation into a standard 3-way valve. The result is a combination valve/safety head with beneficial cost and space advantages.

Standard material of construction is 316 stainless steel.

Safety head assemblies and rupture discs are available in two styles:

The **1/4A** style features a 1/4" blow-out diameter, an angular seat and can be ordered in pressures from 900 to 60,000 PSI (62 to 4140 bar)

The **1/2F** style features a 1/2" blow-out diameter, a flat seat and can be ordered in pressures from 500 to 10,000 PSI (34 to 689 bar). This style also has a reversible hold-down ring which greatly reduces the possibility of premature disc failure associated with installation errors inherent in some designs.

Rupture discs are available in a wide range of burst ratings. Factors such as corrosion, fatigue and temperature may affect the burst pressure of the disc and cause premature failure. This problem may sometimes be overcome by frequent replacement of the disc. All discs rated over 500 PSI (34 bar) have a manufacturing tolerance of 3% under to 6% over the specified rupture pressure rating.

Rupture Discs are not included in the safety head assembly. To order discs separately, use the following part numbering system:

<u>Style</u>	<u>Material</u>	<u>Pressure:</u>
4=1/4" Angled	AL=Aluminum	List desired pressure at 72°F
8=1/2" Flat	IN=Inconel	(21°C) in KSI.
	MO=Monel	
	NI=Nickel	
	SI=Silver	
	SS=316SS	
	TI=Titanium	

Examples:

An Inconel disc rated for 18,000 PSI in 1/4" Angled style would be ordered as **4IN18.00**

An Aluminum disc rated for 750 PSI in 1/2" Flat style would be ordered as **8AL0.750**

SAFETY HEADS - 1/4" ANGLED DISC

Catalog Number	Connection	MAWP	A	B	C	Discharge
FPSH2-1/4A	1/8" NPT	15,000 PSI 1030 bar	1.00" (25.4)	2.62" (66.5)	1.00" (25.4)	3/8" FNPT
FPSH4-1/4A	1/4" NPT	15,000 PSI 1030 bar	1.00" (25.4)	2.87" (72.9)	1.00" (25.4)	3/8" FNPT
FPSH6-1/4A	3/8" NPT	15,000 PSI 1030 bar	1.00" (25.4)	2.87" (72.9)	1.00" (25.4)	3/8" FNPT
FPSH8-1/4A	1/2" NPT	15,000 PSI 1030 bar	1.00" (25.4)	2.68" (68.1)	1.00" (25.4)	3/8" FNPT

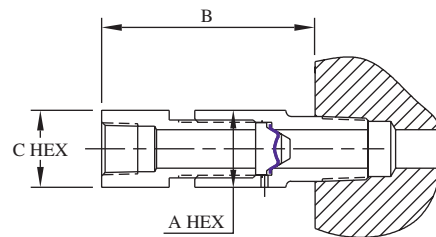

SAFETY HEADS - 1/2" FLAT DISC

Catalog Number	Connection	MAWP	A	B	C	Discharge
FPSH2-1/2F	1/8" NPT	10,000 PSI 689 bar	1.00" (25.4)	2.62" (66.5)	1.00" (25.4)	3/8" FNPT
FPSH4-1/2F	1/4" NPT	10,000 PSI 689 bar	1.00" (25.4)	2.87" (72.9)	1.00" (25.4)	3/8" FNPT
FPSH6-1/2F	3/8" NPT	10,000 PSI 689 bar	1.00" (25.4)	2.87" (72.9)	1.00" (25.4)	3/8" FNPT
FPSH8-1/2F	1/2" NPT	10,000 PSI 689 bar	1.00" (25.4)	2.68" (68.1)	1.00" (25.4)	3/8" FNPT

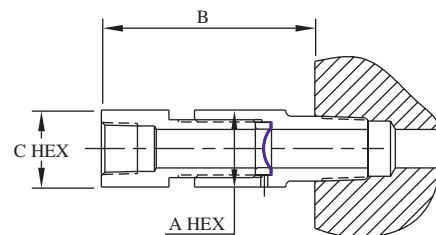

All dimensions are for reference only and are subject to change.
Dimensions in parentheses are millimeters (mm)

LOW PRESSURE VALVES, FITTINGS AND TUBING

BuTech Low Pressure Valves are designed for liquid and gas flow control in petroleum, chemical, power generating and general industrial applications.

Available in a variety of body styles, the valves are designed for operation at temperatures ranging from -100° to +600°F (-73° to +315°C). Optional packings and/or extended stuffing boxes increase the range to -423° to +1200°F (-253° to +648°C).

Their rugged construction provides assurance of fail-safe operation at pressures ranging to 15,000 PSI (1030 bar).

Note: BuTech Pressure Systems does not recommend compression sleeve connections below 0°F (-18°C) or above 650°F (343°C).

Needle Valve Features:

- Non-rotating stem prevents galling and scoring
- Five stem styles:
 - Vee
 - Metering
 - Regulating
 - Micro-Metering
 - Soft Tip
- 17-4PH Stem for longer service life. 316 wetted parts are also available by specifying option **-316WP** (see page LP-3)
- Glass-filled Teflon packing for temperatures up to 600°F (315°C)
- Integral through holes for bracket mounting, a panel-mounting option is also available (see page LP-3)
- Wide range of options allow customizing of valve
- Positive gland locking device

Materials of Construction

Standard materials of construction include 316 cold-worked stainless steel, 17-4PH, Ampco 45, and glass-filled teflon. All BuTech equipment may also be produced in any machinable metal. Some of the more common exotic materials used are:

- Hastelloy™
- Inconel™
- Titanium
- Monel 400™

Tube Sizes: 1/16" through 1/2"
Pressures to 15,000 PSI (1030 bar)
Type: L/P Single Ferrule Compression

Tube O.D.	Connection	Orifice	Cv*	MAWP+
1/16"	1/16" L/P	0.042" (1.1 mm)	0.06	15,000 PSI 1030 bar
1/8"	1/8" L/P	0.094" (2.4 mm)	0.12	15,000 PSI 1030 bar
1/4"	1/4" SL/P	0.125" (3.2 mm)	0.20	11,500 PSI 790 bar
3/8"	3/8" SL/P	0.125" (3.2 mm)	0.20	7,500 PSI 520 bar
1/2"	1/2" L/P	0.375" (9.5 mm)	1.90	5,500 PSI 380 bar

*Cv values listed are for 2-way straight pattern valves excluding metering valves.

For 2-way angle pattern valves, increase Cv value by 50%.

For Metering Valves: Cv=.004, Port size=0.062" (1.57 mm)

+Maximum allowable working pressure at 72° F (22° C)

Equipment	Page
Bulkhead Couplings	LP-11
Caps	LP-9
Check Valves	LP-12
Couplings	LP-11
Crosses	LP-10
Elbows	LP-10
Ferrules	LP-9
Filters	LP-13
Glands	LP-9
Metering and Needle Valves, 1/16"	LP-4
Metering and Needle Valves, 1/8"	LP-5
Metering and Needle Valves, 1/4"	LP-6
Metering and Needle Valves, 3/8"	LP-7
Needle Valves, 1/2"	LP-8
Options	LP-3
Plugs	LP-9
Safety Heads	LP-14
Tees	LP-10
Tubing	LP-9

Ferrules and Glands included with all valves and fittings

All dimensions are for reference only and are subject to change.
 Dimensions in parentheses are millimeters (mm)



ORDERING INFORMATION & REPLACEMENT PARTS

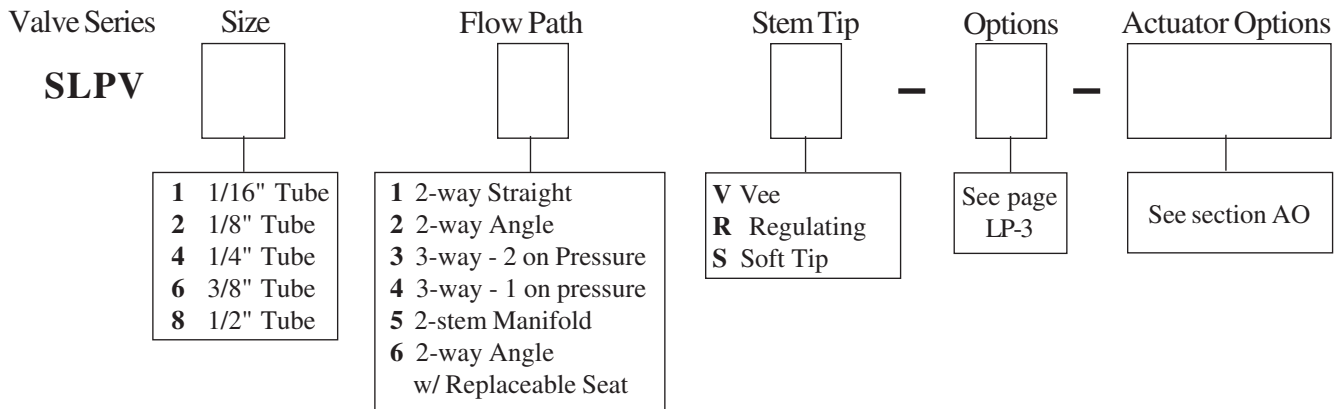

Examples:

SLPV42V specifies a 2-way angle valve for 1/4" tube with a Vee stem

SLPV81R-PM specifies a 2-way straight valve for 1/2" tube with regulating stem and panel-mount packing gland option

Replacement Parts

BuTech offers replacement parts in a variety of packages so you can purchase just the parts you need.

Replacement Stem Kit contains just the stem

Replacement Packing Kit contains all soft packing rings

Repair Kits contain stem, stem sleeve, stem nuts and washers, packings and packing washers (replacement seat where applicable)

Valve Series	Repair Kits		Replacement Stem	Replacement Packings	Replacement Valve Body
	All others	Replaceable Seat			
SLPV1	RK-SLPV1*	RK-SLPV16*	LPS1*	LPPK1	SLPV1+
SLPV2	RK-SLPV2*	RK-SLPV26*	LPS2*	LPPK2	SLPV2+
SLPV4	RK-SLPV4*	RK-SLPV46*	LPS4*	LPPK4	SLPV4+
SLPV6	RK-SLPV6*	RK-SLPV66*	LPS6*	LPPK6	SLPV6+
SLPV8	RK-SLPV8*	RK-SLPV86*	LPS8*	LPPK8	SLPV8+

*Complete catalog number by adding the following:

V, R or **S** for stem type

Suffix for special packing materials (see page LP-3)
(ex. **-GR** for Grafoil packings)

Suffix for special materials
(ex. **-HC** for Hastelloy)

-LT or **-HT** for cryogenic or high-temperature service

-WAO for a valve fitted with an actuator

+Complete catalog number by adding the flow path designator:

- 1** 2-way straight
- 2** 2-way angle
- 3** 3-way, 2 connections on pressure
- 4** 3-way, 1 connection on pressure
- 5** 2-stem manifold
- 6** 2-way angle with replaceable seat

NEEDLE VALVE OPTIONS

Packing and Stem Materials

- GR Grafoil packings for service to 800°F (426°C)
- TFE Virgin Teflon packing for service to 450°F (232°C)
- 316WP 316 wetted parts
- STS Stellite tipped stem
- SRS Stellite replaceable seat (Replaceable seat valves only)

Handle Options

- PH Round plastic handle in place of aluminum
- SS Stainless steel handle in place of aluminum
- EXT_ Handle extended above valve body, specify number of inches of extra height desired (Ex: **EXT6** is a 6" extension)

Security Options

- HLD Handle locking device (prevents unauthorized opening/closing of valve)
- SLD Stem locking device (prevents stem from turning due to vibration)

Extreme Service

- O2 Cleaned for oxygen service
- HT Extended stuffing box, graphite packing, and materials for high-temperature service to 1200°F (648°C)
- HTF Finned extended stuffing box, graphite packing, and materials for high-temperature service to 1200°F (648°C)
- LT Extended stuffing box, teflon packing, and materials for cryogenic service to -423°F (-251°C)
- LTF Finned extended stuffing box, teflon packing, and materials for cryogenic service to -423°F (-251°C)

Valve Model	A
SLPV1	N/A
SLPV2	N/A
SLPV4	5.82" (147.8)
SLPV6	5.82" (147.8)
SLPV8	7.22" (183.4)

-HT or -LT Options

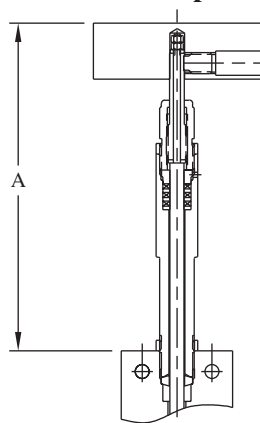

Cylindrical Bonnet

-HTF or -LTF Options

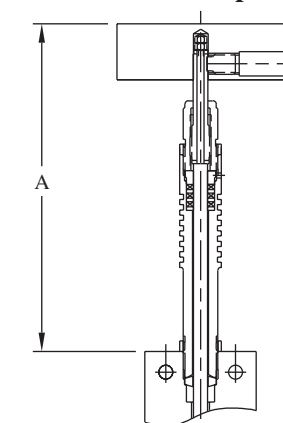

Finned Bonnet

Panel Mount

- PM Panel-mount packing gland

Valve Model	Panel Hole Size	Max Panel Thickness	H
SLPV1	0.47" (11.9)	0.25" (6.4)	0.41" (10.4)
SLPV2	0.47" (11.9)	0.25" (6.4)	0.41" (10.4)
SLPV4	0.66" (16.8)	0.25" (6.4)	0.54" (13.7)
SLPV6	0.66" (16.8)	0.25" (6.4)	0.54" (13.7)
SLPV8	0.78" (19.8)	0.44" (11.2)	0.50" (12.7)

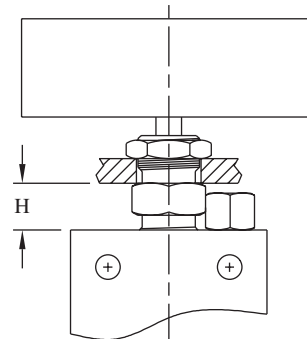

All dimensions are for reference only and are subject to change.
Dimensions in parentheses are millimeters (mm)

NEEDLE VALVES FOR 15,000 PSI (1030 BAR)

1/16" L/P TUBE, SINGLE FERRULE COMPRESSION

2-way Straight

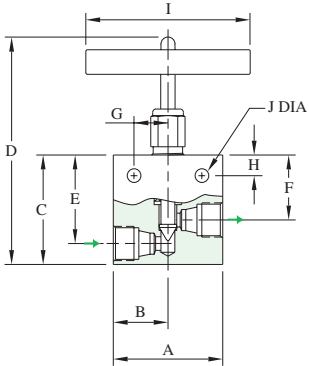

Figure 1

2-way Angle

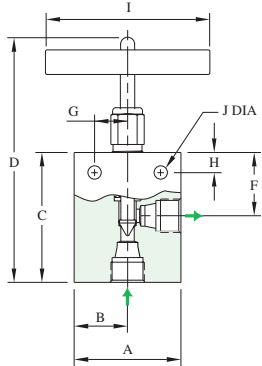

Figure 2

3-way Two on Pressure

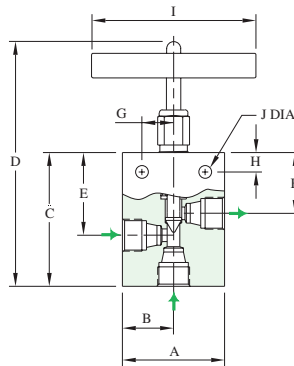

Figure 3

3-way One on Pressure

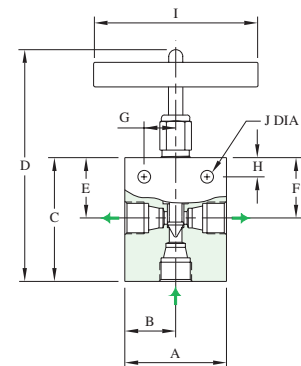

Figure 4

Catalog Number	Stem Style	Connection	A	B	C	D	E	F	G	H	I	J	K	L	Thk.	Fig
SLPV11V	Vee	1/16" L/P	1.50"	0.75"	1.38"	3.82"	1.06"	0.81"	0.50"	0.31"	2.37"	0.17"	---	---	0.62"	1
SLPV11R	Reg	Tube	(38.1)	(19.1)	(35.1)	(97.0)	(26.9)	(20.6)	(12.7)	(7.9)	(60.2)	(4.3)	---	---	(15.7)	
SLPV12V	Vee	1/16" L/P	1.50"	0.75"	1.56"	4.00"	---	0.81"	0.50"	0.31"	2.37"	0.17"	---	---	0.62"	2
SLPV12R	Reg	Tube	(38.1)	(19.1)	(39.6)	(101.6)	---	(20.6)	(12.7)	(7.9)	(60.2)	(4.3)	---	---	(15.7)	
SLPV13V	Vee	1/16" L/P	1.50"	0.75"	1.69"	4.13"	1.06"	0.81"	0.50"	0.31"	2.37"	0.17"	---	---	0.62"	3
SLPV13R	Reg	Tube	(38.1)	(19.1)	(42.9)	(104.9)	(26.9)	(20.6)	(12.7)	(7.9)	(60.2)	(4.3)	---	---	(15.7)	
SLPV14V	Vee	1/16" L/P	1.50"	0.75"	1.56"	4.00"	0.81"	0.81"	0.50"	0.31"	2.37"	0.17"	---	---	0.62"	4
SLPV14R	Reg	Tube	(38.1)	(19.1)	(39.6)	(101.6)	(20.6)	(20.6)	(12.7)	(7.9)	(60.2)	(4.3)	---	---	(15.7)	
SLPV15V	Vee	1/16" L/P	1.50"	0.75"	2.25"	7.13"	1.12"	0.81"	0.50"	0.31"	2.37"	0.17"	---	---	0.62"	5
SLPV15R	Reg	Tube	(38.1)	(19.1)	(57.2)	(181.1)	(28.4)	(20.6)	(12.7)	(7.9)	(60.2)	(4.3)	---	---	(15.7)	
SLPV16V	Vee	1/16" L/P	1.50"	0.75"	1.69"	4.13"	---	0.81"	0.50"	0.31"	2.37"	0.17"	0.50"	0.63"	0.62"	6
SLPV16R	Reg	Tube	(38.1)	(19.1)	(42.9)	(104.9)	---	(20.6)	(12.7)	(7.9)	(60.2)	(4.3)	(12.7)	(16.0)	(15.7)	
SLPMV16V	Meter	1/16" L/P	1.38"	0.87"	1.56"	5.40"	---	0.94"	0.19"	0.44"	2.37"	0.16"	0.56"	0.72"	0.75"	7
		Tube	(35.1)	(22.1)	(39.6)	(137.2)	---	(23.9)	(4.8)	(11.2)	(60.2)	(4.1)	(14.2)	(18.3)	(19.1)	
SLPMMV16V	Micro-Meter	1/16" L/P	1.38"	0.87"	1.56"	5.42"	---	0.94"	0.19"	0.44"	2.37"	0.16"	0.56"	0.72"	0.75"	8
		Tube	(35.1)	(22.1)	(39.6)	(137.7)	---	(23.9)	(4.8)	(11.2)	(60.2)	(4.1)	(14.2)	(18.3)	(19.1)	

See page LP-1 for orifice and Cv

2-stem Manifold

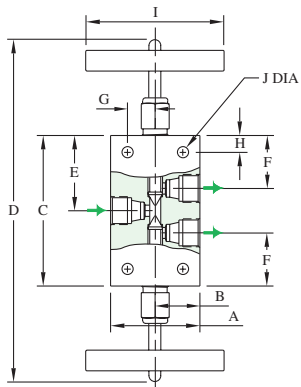

Figure 5

Replaceable Seat

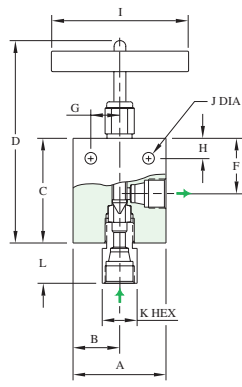

Figure 6

Metering

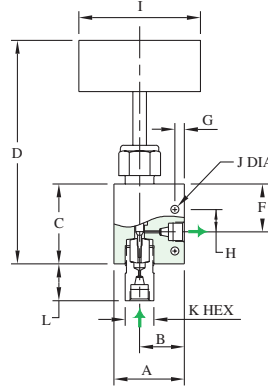

Figure 7

Micro-Metering

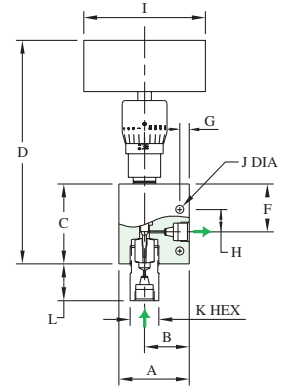

Figure 8

All dimensions are for reference only and are subject to change.
Dimensions in parentheses are millimeters (mm)

NEEDLE VALVES FOR 15,000 PSI (1030 BAR)

1/8" L/P TUBE, SINGLE FERRULE COMPRESSION

2-way Straight

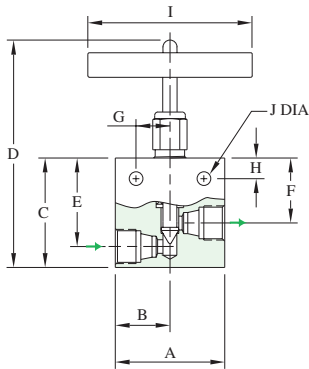

Figure 1

2-way Angle

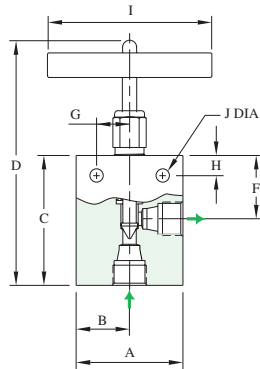

Figure 2

3-way Two on Pressure

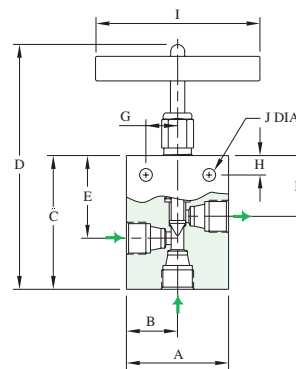

Figure 3

3-way One on Pressure

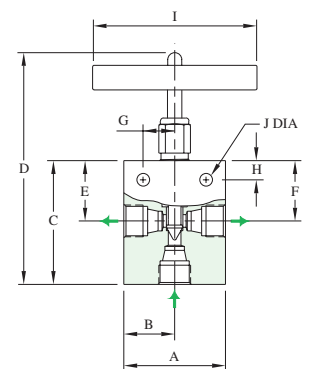

Figure 4

Catalog Number	Stem Style	Connection	A	B	C	D	E	F	G	H	I	J	K	L	Thk.	Fig
SLPV21V	Vee	1/8" L/P	1.50"	0.75"	1.38"	3.82"	1.06"	0.81"	0.50"	0.31"	2.37"	0.17"	---	---	0.62"	1
SLPV21R	Reg	Tube	(38.1)	(19.1)	(35.1)	(97.0)	(26.9)	(20.6)	(12.7)	(7.9)	(60.2)	(4.3)	---	---	(15.7)	
SLPV22V	Vee	1/8" L/P	1.50"	0.75"	1.56"	4.00"	---	0.81"	0.50"	0.31"	2.37"	0.17"	---	---	0.62"	2
SLPV22R	Reg	Tube	(38.1)	(19.1)	(39.6)	(101.6)	---	(20.6)	(12.7)	(7.9)	(60.2)	(4.3)	---	---	(15.7)	
SLPV23V	Vee	1/8" L/P	1.50"	0.75"	1.69"	4.13"	1.06"	0.81"	0.50"	0.31"	2.37"	0.17"	---	---	0.62"	3
SLPV23R	Reg	Tube	(38.1)	(19.1)	(42.9)	(104.9)	(26.9)	(20.6)	(12.7)	(7.9)	(60.2)	(4.3)	---	---	(15.7)	
SLPV24V	Vee	1/8" L/P	1.50"	0.75"	1.56"	4.00"	0.81"	0.81"	0.50"	0.31"	2.37"	0.17"	---	---	0.62"	4
SLPV24R	Reg	Tube	(38.1)	(19.1)	(39.6)	(101.6)	(20.6)	(20.6)	(12.7)	(7.9)	(60.2)	(4.3)	---	---	(15.7)	
SLPV25V	Vee	1/8" L/P	1.50"	0.75"	2.25"	7.13"	1.12"	0.81"	0.50"	0.31"	2.37"	0.17"	---	---	0.62"	5
SLPV25R	Reg	Tube	(38.1)	(19.1)	(57.2)	(181.1)	(28.4)	(20.6)	(12.7)	(7.9)	(60.2)	(4.3)	---	---	(15.7)	
SLPV26V	Vee	1/8" L/P	1.50"	0.75"	1.69"	4.13"	---	0.81"	0.50"	0.31"	2.37"	0.17"	0.50"	0.63"	0.62"	6
SLPV26R	Reg	Tube	(38.1)	(19.1)	(42.9)	(104.9)	---	(20.6)	(12.7)	(7.9)	(60.2)	(4.3)	(12.7)	(16.0)	(15.7)	
SLPMV26V	Meter	1/8" L/P	1.38"	0.87"	1.56"	5.40"	---	0.94"	0.19"	0.44"	2.37"	0.16"	0.56"	0.72"	0.75"	7
SLPMV26R	Reg	Tube	(35.1)	(22.1)	(39.6)	(137.2)	---	(23.9)	(4.8)	(11.2)	(60.2)	(4.1)	(14.2)	(18.3)	(19.1)	
SLPMMV26V	Micro-Meter	1/8" L/P	1.38"	0.87"	1.56"	5.42"	---	0.94"	0.19"	0.44"	2.37"	0.16"	0.56"	0.72"	0.75"	8
SLPMMV26R	Reg	Tube	(35.1)	(22.1)	(39.6)	(137.7)	---	(23.9)	(4.8)	(11.2)	(60.2)	(4.1)	(14.2)	(18.3)	(19.1)	

See page LP-1 for orifice and Cv

2-stem Manifold

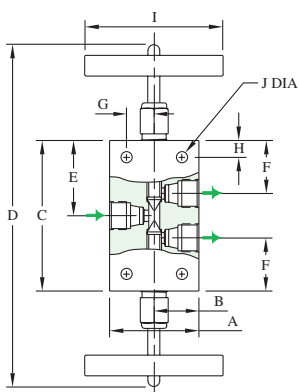

Figure 5

Replaceable Seat

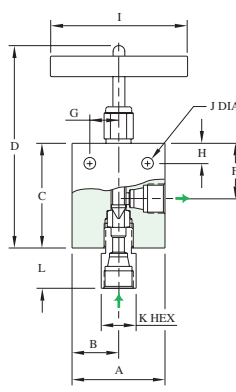

Figure 6

Metering

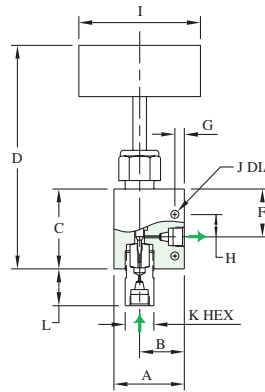

Figure 7

Micro-Metering

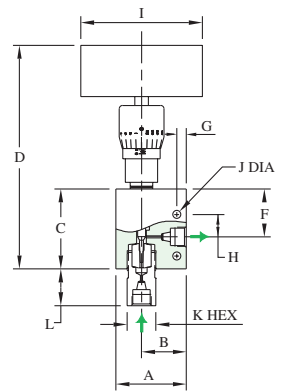

Figure 8



All dimensions are for reference only and are subject to change.
Dimensions in parentheses are millimeters (mm)

NEEDLE VALVES FOR 11,500 PSI (790 BAR)

1/4" SL/P TUBE, SINGLE FERRULE COMPRESSION

2-way Straight

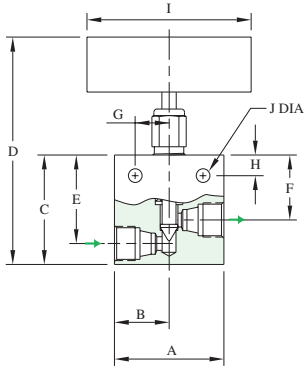

Figure 1

2-way Angle

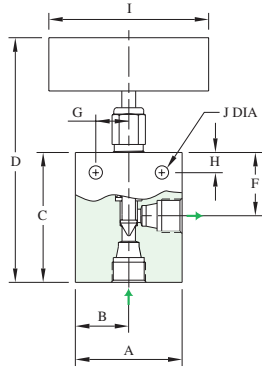

Figure 2

3-way Two on Pressure

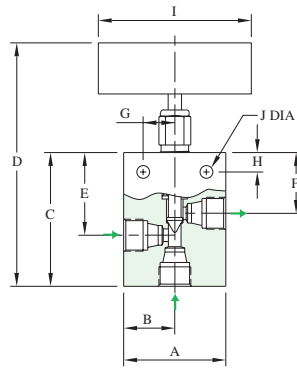

Figure 3

3-way One on Pressure

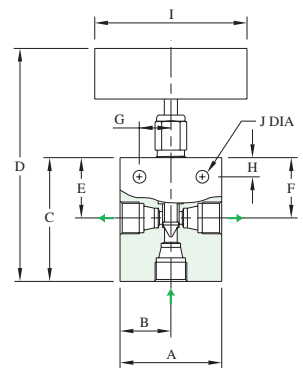

Figure 4

Catalog Number	Stem Style	Connection	A	B	C	D	E	F	G	H	I	J	K	L	Thk.	Fig
SLPV41V	Vee	1/4" SL/P	2.00"	1.00"	2.00"	4.50"	1.62"	1.19"	0.62"	0.38"	3.00"	0.25"	---	---	0.75"	1
SLPV41R	Reg	Tube	(50.8)	(25.4)	(50.8)	(114.3)	(41.1)	(30.2)	(15.7)	(9.7)	(76.2)	(6.4)	---	---	(19.1)	
SLPV42V	Vee	1/4" SL/P	2.00"	1.00"	2.44"	4.94"	---	1.19"	0.62"	0.38"	3.00"	0.25"	---	---	0.75"	2
SLPV42R	Reg	Tube	(50.8)	(25.4)	(62.0)	(125.5)	---	(30.2)	(15.7)	(9.7)	(76.2)	(6.4)	---	---	(19.1)	
SLPV43V	Vee	1/4" SL/P	2.00"	1.00"	2.62"	5.12"	1.62"	1.19"	0.62"	0.38"	3.00"	0.25"	---	---	0.75"	3
SLPV43R	Reg	Tube	(50.8)	(25.4)	(66.5)	(130.0)	(41.1)	(30.2)	(15.7)	(9.7)	(76.2)	(6.4)	---	---	(19.1)	
SLPV44V	Vee	1/4" SL/P	2.00"	1.00"	2.44"	4.94"	1.19"	1.19"	0.62"	0.38"	3.00"	0.25"	---	---	0.75"	4
SLPV44R	Reg	Tube	(50.8)	(25.4)	(62.0)	(125.5)	(30.2)	(30.2)	(15.7)	(9.7)	(76.2)	(6.4)	---	---	(19.1)	
SLPV45V	Vee	1/4" SL/P	2.00"	1.00"	3.38"	8.38"	1.68"	1.19"	0.62"	0.38"	3.00"	0.25"	---	---	0.75"	5
SLPV45R	Reg	Tube	(50.8)	(25.4)	(85.9)	(212.9)	(42.7)	(30.2)	(15.7)	(9.7)	(76.2)	(6.4)	---	---	(19.1)	
SLPV46V	Vee	1/4" SL/P	2.00"	1.00"	2.25"	4.75"	---	1.19"	0.62"	0.38"	3.00"	0.25"	0.50"	0.63"	0.75"	6
SLPV46R	Reg	Tube	(50.8)	(25.4)	(57.2)	(120.7)	---	(30.2)	(15.7)	(9.7)	(76.2)	(6.4)	(12.7)	(16.0)	(19.1)	
SLPMV46V	Meter	1/4" SL/P	2.50"	1.25"	2.62"	6.69"	---	1.31"	0.69"	0.38"	3.00"	0.25"	0.75"	1.03"	1.00"	7
	Tube		(63.5)	(31.8)	(66.5)	(169.9)	---	(33.3)	(17.5)	(9.7)	(76.2)	(6.4)	(19.1)	(26.2)	(25.4)	
SLPMMV46V	Micro-Meter	1/4" SL/P	2.50"	1.25"	2.62"	7.33"	---	1.31"	0.69"	0.38"	2.35"	0.25"	0.75"	1.03"	1.00"	8
	Tube		(63.5)	(31.8)	(66.5)	(186.2)	---	(33.3)	(17.5)	(9.7)	(59.7)	(6.4)	(19.1)	(26.2)	(25.4)	

See page LP-1 for orifice and Cv

2-stem Manifold

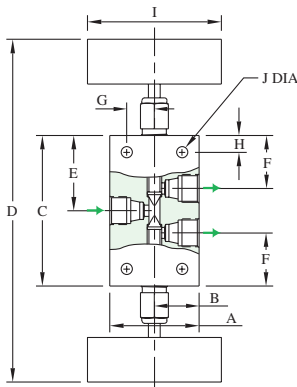

Figure 5

Replaceable Seat

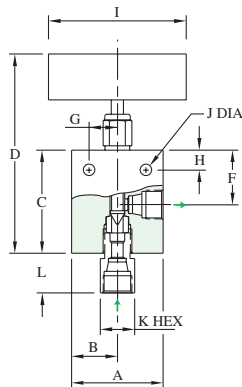

Figure 6

Metering

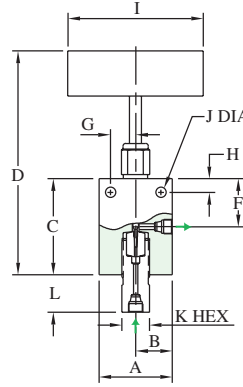

Figure 7

Micro-Metering

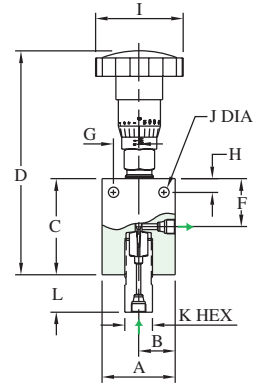

Figure 8

All dimensions are for reference only and are subject to change.
Dimensions in parentheses are millimeters (mm)

NEEDLE VALVES FOR 7,500 PSI (520 BAR)

3/8" SL/P TUBE, SINGLE FERRULE COMPRESSION

2-way Straight

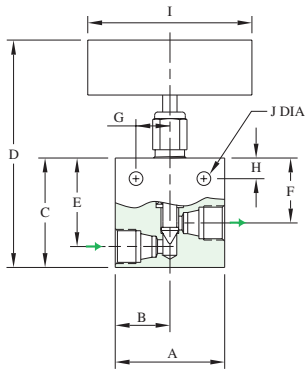

Figure 1

2-way Angle

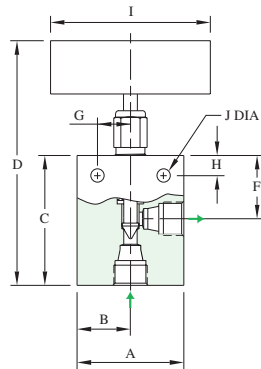

Figure 2

3-way Two on Pressure

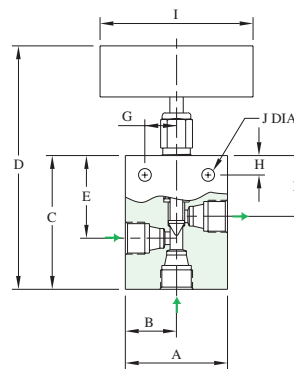

Figure 3

3-way One on Pressure

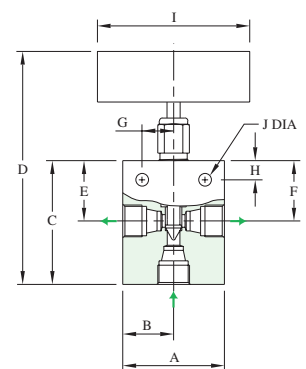

Figure 4

Catalog Number	Stem Style	Connection	A	B	C	D	E	F	G	H	I	J	K	L	Thk.	Fig
SLPV61V SLPV61R	Vee Reg	3/8" SL/P Tube	2.00" (50.8)	1.00" (25.4)	2.00" (50.8)	4.50" (114.3)	1.62" (41.1)	1.19" (30.2)	0.62" (15.7)	0.38" (9.7)	3.00" (76.2)	0.25" (6.4)	---	---	0.75" (19.1)	1
SLPV62V SLPV62R	Vee Reg	3/8" SL/P Tube	2.00" (50.8)	1.00" (25.4)	2.44" (62.0)	4.94" (125.5)	---	1.19" (30.2)	0.62" (15.7)	0.38" (9.7)	3.00" (76.2)	0.25" (6.4)	---	---	0.75" (19.1)	2
SLPV63V SLPV63R	Vee Reg	3/8" SL/P Tube	2.00" (50.8)	1.00" (25.4)	2.62" (66.5)	5.12" (130.0)	1.62" (41.1)	1.19" (30.2)	0.62" (15.7)	0.38" (9.7)	3.00" (76.2)	0.25" (6.4)	---	---	0.75" (19.1)	3
SLPV64V SLPV64R	Vee Reg	3/8" SL/P Tube	2.00" (50.8)	1.00" (25.4)	2.44" (62.0)	4.94" (125.5)	1.19" (30.2)	1.19" (30.2)	0.62" (15.7)	0.38" (9.7)	3.00" (76.2)	0.25" (6.4)	---	---	0.75" (19.1)	4
SLPV65V SLPV65R	Vee Reg	3/8" SL/P Tube	2.00" (50.8)	1.00" (25.4)	3.38" (85.9)	8.38" (212.9)	1.68" (42.7)	1.19" (30.2)	0.62" (15.7)	0.38" (9.7)	3.00" (76.2)	0.25" (6.4)	---	---	0.75" (19.1)	5
SLPV66V SLPV66R	Vee Reg	3/8" SL/P Tube	2.00" (50.8)	1.00" (25.4)	2.25" (57.2)	4.75" (120.7)	---	1.19" (30.2)	0.62" (15.7)	0.38" (9.7)	3.00" (76.2)	0.25" (6.4)	0.50" (12.7)	0.63" (16.0)	0.75" (19.1)	6
SLPMV66V	Meter	3/8" SL/P Tube	2.50" (63.5)	1.25" (31.8)	2.62" (66.5)	6.69" (169.9)	---	1.31" (33.3)	0.69" (17.5)	0.38" (9.7)	3.00" (76.2)	0.25" (6.4)	0.75" (19.1)	1.03" (26.2)	1.00" (25.4)	7
SLPMMV66V	Micro-Meter	3/8" SL/P Tube	2.50" (63.5)	1.25" (31.8)	2.62" (66.5)	7.33" (186.2)	---	1.31" (33.3)	0.69" (17.5)	0.38" (9.7)	2.35" (59.7)	0.25" (6.4)	0.75" (19.1)	1.03" (26.2)	1.00" (25.4)	8

See page LP-1 for orifice and Cv

2-stem Manifold

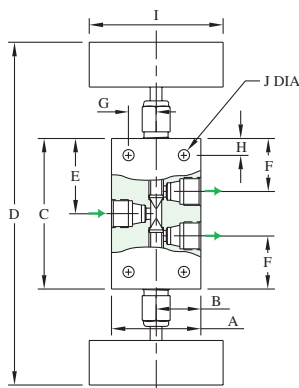

Figure 5

Replaceable Seat

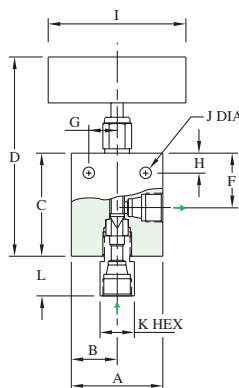

Figure 6

Metering

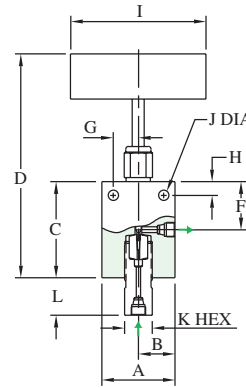

Figure 7

Micro-Metering

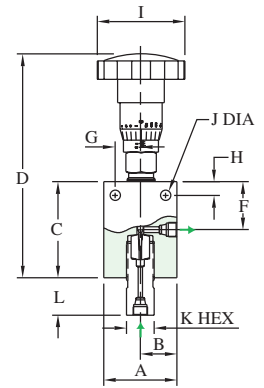

Figure 8

All dimensions are for reference only and are subject to change.
Dimensions in parentheses are millimeters (mm)

NEEDLE VALVES FOR 5,500 PSI (380 BAR)

1/2" L/P TUBE, SINGLE FERRULE COMPRESSION

2-way Straight

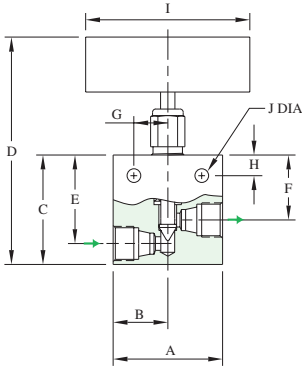

Figure 1

2-way Angle

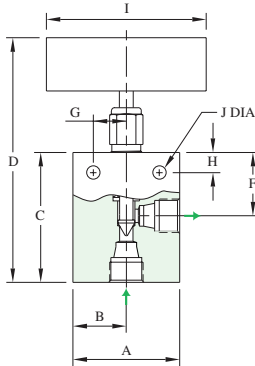

Figure 2

3-way Two on Pressure

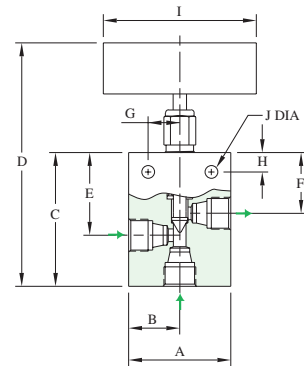

Figure 3

Catalog Number	Stem Style	Connection	A	B	C	D	E	F	G	H	I	J	K	L	Thk.	Fig
SLPV81V	Vee	1/2" L/P	2.50"	1.25"	2.88"	6.32"	2.38"	1.75"	0.69"	0.50"	4.00"	0.34"	---	---	1.00"	1
SLPV81R	Reg	Tube	(63.5)	(31.8)	(73.2)	(160.5)	(60.5)	(44.5)	(17.5)	(12.7)	(101.6)	(8.6)	---	---	(25.4)	
SLPV82V	Vee	1/2" L/P	2.50"	1.25"	3.38"	6.82"	---	1.75"	0.69"	0.50"	4.00"	0.34"	---	---	1.00"	2
SLPV82R	Reg	Tube	(63.5)	(31.8)	(85.9)	(173.2)	---	(44.5)	(17.5)	(12.7)	(101.6)	(8.6)	---	---	(25.4)	
SLPV83V	Vee	1/2" L/P	2.50"	1.25"	3.62"	7.06"	2.38"	1.75"	0.69"	0.50"	4.00"	0.34"	---	---	1.00"	3
SLPV83R	Reg	Tube	(63.5)	(31.8)	(91.9)	(179.3)	(60.5)	(44.5)	(17.5)	(12.7)	(101.6)	(8.6)	---	---	(25.4)	
SLPV84V	Vee	1/2" L/P	2.50"	1.25"	3.38"	6.82"	1.75"	1.75"	0.69"	0.50"	4.00"	0.34"	---	---	1.00"	4
SLPV84R	Reg	Tube	(63.5)	(31.8)	(85.9)	(173.2)	(44.5)	(44.5)	(17.5)	(12.7)	(101.6)	(8.6)	---	---	(25.4)	
SLPV85V	Vee	1/2" L/P	2.50"	1.25"	5.12"	12.00"	2.56"	1.75"	0.69"	0.50"	4.00"	0.34"	---	---	1.00"	5
SLPV85R	Reg	Tube	(63.5)	(31.8)	(130.0)	(304.8)	(65.0)	(44.5)	(17.5)	(12.7)	(101.6)	(8.6)	---	---	(25.4)	
SLPV86V	Vee	1/2" L/P	2.50"	1.25"	3.25"	7.72"	---	1.75"	0.69"	0.50"	4.00"	0.34"	0.75"	0.63"	1.00"	6
SLPV86R	Reg	Tube	(63.5)	(31.8)	(82.6)	(196.1)	---	(44.5)	(17.5)	(12.7)	(101.6)	(8.6)	(19.1)	(16.0)	(25.4)	

See page LP-1 for orifice and Cv

3-way One on Pressure

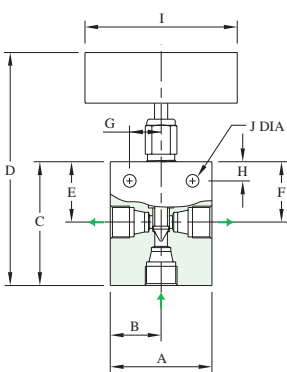

Figure 4

2-stem Manifold

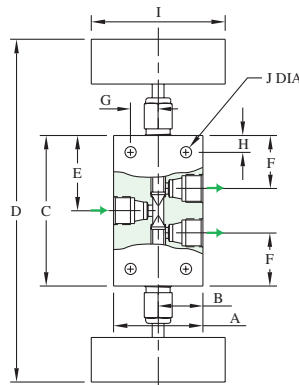

Figure 5

Replaceable Seat

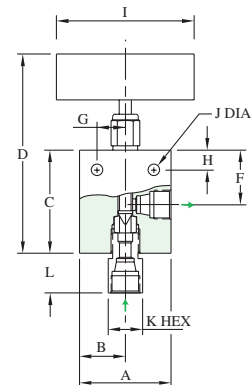

Figure 6

All dimensions are for reference only and are subject to change.
Dimensions in parentheses are millimeters (mm)

LOW PRESSURE CONNECTION COMPONENTS & TUBING

Connection Components

All BuTech valves and fittings are supplied with glands and ferrules. To order these components separately, use catalog numbers listed below. When using a plug, the ferrule is not required.

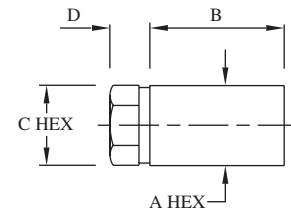

Tube Size	Ferrule	Gland	Plug
1/16" L/P	LPF1	LPG1	LPP1
1/8" L/P	LPF2	LPG2	LPP2
1/4" SL/P	LPF4	SLPG4	LPP4
3/8" SL/P	LPF6	SLPG6	LPP6
1/2" L/P	LPF8	LPG8	LPP8

Cap	A	B	C	D
LCA1	0.50" (12.7)	1.25" (31.8)	0.50" (12.7)	0.31" (7.9)
LPCA2	0.50" (12.7)	1.25" (31.8)	0.50" (12.7)	0.31" (7.9)
LPCA4	0.63" (16.0)	1.62" (41.1)	0.81" (20.6)	0.56" (14.2)
LPCA6	0.75" (19.1)	1.00" (25.4)	0.81" (20.6)	0.62" (15.7)
LPCA8	1.00" (25.4)	1.25" (31.8)	0.75" (19.1)	0.53" (13.5)

Tubing

Catalog Number	Connection	O.D.	I.D.	MAWP
LP062-031-*	1/16" L/P	0.062" (1.6)	0.031" (0.8)	15,000 PSI 1030 bar
LP125-062-*	1/8" L/P	0.125" (3.2)	0.062" (1.6)	15,000 PSI 1030 bar
LP250-125-*	1/4" L/P	0.250" (6.4)	0.125" (3.2)	11,500 PSI 790 bar
LP375-250-*	3/8" L/P	0.375" (9.5)	0.250" (6.4)	7,500 PSI 520 bar
LP500-334-*	1/2" L/P	0.500" (12.7)	0.334" (8.5)	7,000 PSI 480 bar
LP500-375-*	1/2" L/P	0.500" (12.7)	0.375" (9.5)	5,500 PSI 380 bar

*Complete catalog number by adding suffix **316** for 316 stainless steel or suffix **304** for 304 stainless steel. Other materials are also available, please consult factory.

BuTech Pressure Systems offers a complete selection of annealed seamless stainless steel tubing for high pressure applications where both high strength and corrosion resistance are desired. Tubing is available in standard 20-24 foot lengths (6-7 meters), however, longer lengths are available on request.



See Section T for Tube Benders and Tube Vises!

All dimensions are for reference only and are subject to change.
Dimensions in parentheses are millimeters (mm)

LOW PRESSURE EQUIPMENT

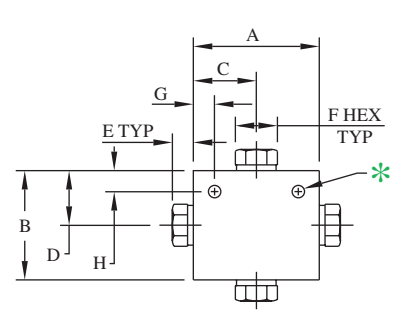
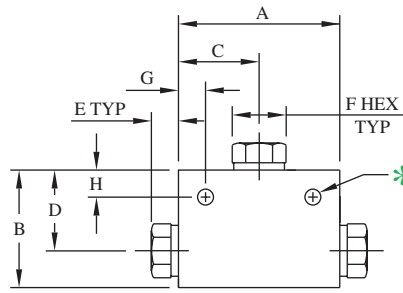
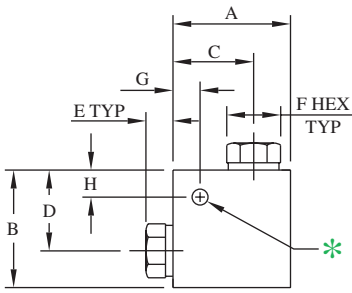

ELBOWS

Catalog Number	Connection	Port	MAWP	A	B	C	D	E	F	Block Thickness	Mounting Holes*		
											G	H	Dia.
LPL1	1/16" L/P Tube	0.042" (1.1)	15,000 PSI 1030 bar	1.00" (25.4)	1.00" (25.4)	0.75" (19.1)	0.75" (19.1)	0.31" (7.9)	0.50" (12.7)	0.50" (12.7)	0.30" (7.6)	0.31" (7.9)	0.21" (5.3)
LPL2	1/8" L/P Tube	0.094" (2.4)	15,000 PSI 1030 bar	1.00" (25.4)	1.00" (25.4)	0.75" (19.1)	0.75" (19.1)	0.31" (7.9)	0.50" (12.7)	0.50" (12.7)	0.30" (7.6)	0.31" (7.9)	0.21" (5.3)
LPL4	1/4" SL/P Tube	0.187" (4.7)	11,500 PSI 790 bar	1.19" (30.2)	1.19" (30.2)	0.88" (22.4)	0.88" (22.4)	0.56" (14.2)	0.81" (20.6)	0.62" (15.7)	0.31" (7.9)	0.31" (7.9)	0.22" (5.6)
LPL6	3/8" SL/P Tube	0.250" (6.4)	7,500 PSI 520 bar	1.38" (35.1)	1.38" (35.1)	1.00" (25.4)	1.00" (25.4)	0.62" (15.7)	0.81" (20.6)	0.75" (19.1)	0.31" (7.9)	0.31" (7.9)	0.28" (7.1)
LPL8	1/2" L/P Tube	0.437" (11.1)	5,500 PSI 380 bar	1.75" (44.5)	1.75" (44.5)	1.25" (31.8)	1.25" (31.8)	0.53" (13.5)	0.75" (19.1)	1.00" (25.4)	0.50" (12.7)	0.50" (12.7)	0.28" (7.1)

TEES

Catalog Number	Connection	Port	MAWP	A	B	C	D	E	F	Block Thickness	Mounting Holes*		
											G	H	Dia.
LPT1	1/16" L/P Tube	0.042" (1.1)	15,000 PSI 1030 bar	1.50" (38.1)	1.00" (25.4)	0.75" (19.1)	0.75" (19.1)	0.31" (7.9)	0.50" (12.7)	0.62" (15.7)	0.30" (7.6)	0.31" (7.9)	0.21" (5.3)
LPT2	1/8" L/P Tube	0.094" (2.4)	15,000 PSI 1030 bar	1.50" (38.1)	1.00" (25.4)	0.75" (19.1)	0.75" (19.1)	0.31" (7.9)	0.50" (12.7)	0.62" (15.7)	0.30" (7.6)	0.31" (7.9)	0.21" (5.3)
LPT4	1/4" SL/P Tube	0.187" (4.7)	11,500 PSI 790 bar	1.75" (44.5)	1.19" (30.2)	0.88" (22.4)	0.88" (22.4)	0.56" (14.2)	0.81" (20.6)	0.62" (15.7)	0.25" (6.4)	0.25" (6.4)	0.28" (7.1)
LPT6	3/8" SL/P Tube	0.250" (6.4)	7,500 PSI 520 bar	2.00" (50.8)	1.38" (35.1)	1.00" (25.4)	1.00" (25.4)	0.62" (15.7)	0.81" (20.6)	0.75" (19.1)	0.31" (7.9)	0.31" (7.9)	0.28" (7.1)
LPT8	1/2" L/P Tube	0.437" (11.1)	5,500 PSI 380 bar	2.50" (63.5)	1.75" (44.5)	1.25" (31.8)	1.25" (31.8)	0.53" (13.5)	0.75" (19.1)	1.00" (25.4)	0.50" (12.7)	0.50" (12.7)	0.28" (7.1)

CROSSES

Catalog Number	Connection	Port	MAWP	A	B	C	D	E	F	Block Thickness	Mounting Holes*		
											G	H	Dia.
LPX1	1/16" L/P Tube	0.042" (1.1)	15,000 PSI 860 bar	1.38" (35.1)	1.50" (38.1)	0.69" (17.5)	0.75" (19.1)	0.31" (7.9)	0.50" (12.7)	0.62" (15.7)	0.24" (6.1)	0.31" (7.9)	0.21" (5.3)
LPX2	1/8" L/P Tube	0.094" (2.4)	15,000 PSI 860 bar	1.38" (35.1)	1.50" (38.1)	0.69" (17.5)	0.75" (19.1)	0.31" (7.9)	0.50" (12.7)	0.62" (15.7)	0.24" (6.1)	0.31" (7.9)	0.21" (5.3)
LPX4	1/4" SL/P Tube	0.187" (4.7)	11,500 PSI 790 bar	1.75" (44.5)	1.75" (44.5)	0.88" (22.4)	0.88" (22.4)	0.56" (14.2)	0.81" (20.6)	0.62" (15.7)	0.25" (6.4)	0.25" (6.4)	0.21" (5.3)
LPX6	3/8" SL/P Tube	0.250" (6.4)	7,500 PSI 520 bar	2.00" (50.8)	2.00" (50.8)	1.00" (25.4)	1.00" (25.4)	0.62" (15.7)	0.81" (20.6)	0.75" (19.1)	0.31" (7.9)	0.38" (9.7)	0.28" (7.1)
LPX8	1/2" L/P Tube	0.437" (11.1)	5,500 PSI 380 bar	2.50" (63.5)	2.50" (63.5)	1.25" (31.8)	1.25" (31.8)	0.53" (13.5)	0.75" (19.1)	1.00" (25.4)	0.50" (12.7)	0.50" (12.7)	0.28" (7.1)

*Mounting holes provided when the catalog number is suffixed by "-MH" when ordering.

All dimensions are for reference only and are subject to change.
Dimensions in parentheses are millimeters (mm)



LOW PRESSURE EQUIPMENT

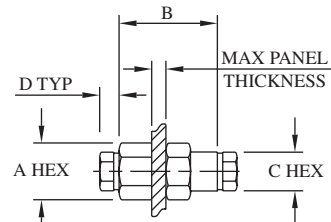
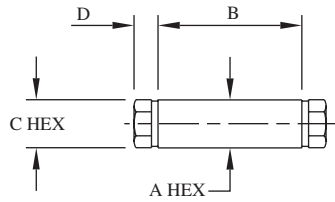

See bulkhead table below
for panel hole drill size

COUPLINGS

Catalog Number	Connection	Port	MAWP	A	B	C	D
LPC1	1/16" L/P Tube	0.042" (1.1)	15,000 PSI 1030 bar	0.50" (12.7)	1.25" (31.8)	0.50" (12.7)	0.31" (7.9)
LPC2	1/8" L/P Tube	0.094" (2.4)	15,000 PSI 1030 bar	0.50" (12.7)	1.25" (31.8)	0.50" (12.7)	0.31" (7.9)
LPC4	1/4" SL/P Tube	0.187" (4.7)	11,500 PSI 790 bar	0.62" (15.7)	1.62" (41.1)	0.81" (20.6)	0.56" (14.2)
LPC6	3/8" SL/P Tube	0.250" (6.4)	7,500 PSI 520 bar	0.75" (19.1)	1.75" (44.5)	0.81" (20.6)	0.62" (15.7)
LPC8	1/2" L/P Tube	0.437" (11.1)	5,500 PSI 380 bar	1.00" (25.4)	2.00" (50.8)	0.75" (19.1)	0.53" (13.5)

BULKHEADS

Catalog Number	Connection	Port	MAWP	A	B	C	D	Panel Hole	Panel Thickness
LPBF1	1/16" L/P Tube	0.042" (1.1)	15,000 PSI 1030 bar	0.75" (19.1)	1.75" (44.5)	0.50" (12.7)	0.31" (7.9)	0.62" (15.7)	0.38" (9.7)
LPBF2	1/8" L/P Tube	0.094" (2.4)	15,000 PSI 1030 bar	0.75" (19.1)	1.75" (44.5)	0.50" (12.7)	0.31" (7.9)	0.62" (15.7)	0.38" (9.7)
LPBF4	1/4" SL/P Tube	0.187" (4.7)	11,500 PSI 790 bar	1.00" (25.4)	1.88" (47.8)	0.81" (20.6)	0.56" (14.2)	0.88" (22.4)	0.38" (9.7)
LPBF6	3/8" SL/P Tube	0.250" (6.4)	7,500 PSI 520 bar	1.00" (25.4)	1.88" (47.8)	0.81" (20.6)	0.62" (15.7)	0.88" (22.4)	0.38" (9.7)
LPBF8	1/2" L/P Tube	0.437" (11.1)	5,500 PSI 380 bar	1.38" (35.1)	2.38" (60.5)	0.75" (19.1)	0.53" (13.5)	1.25" (31.8)	0.50" (12.7)



All dimensions are for reference only and are subject to change.
Dimensions in parentheses are millimeters (mm)

LOW PRESSURE CHECK VALVES

BuTech ball check valves prevent reverse flow where leak-tight shutoff is not necessary. Standard materials of construction are 316 stainless steel with 17-4PH poppet for long life, and 300 series stainless steel spring.

Note: For 316 stainless steel wetted parts, add **-316WP** to the catalog number.

Cracking pressure: 15 PSI (1 bar) approximate
 Operating Temperature Range:
 -420° to +1200°F
 (-251° to +648°C)

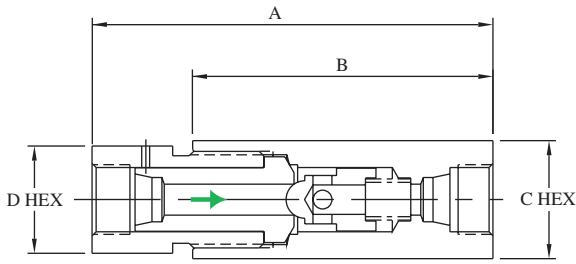

BALL CHECK VALVES

Catalog Number	Connection	MAWP	Cv	A	B	C	D
LPBC2	1/8" L/P Tube	15,000 PSI 1030 bar	0.15	2.38" (60.5)	1.88" (47.8)	0.50" (12.7)	0.62" (15.7)
LPBC4	1/4" SL/P Tube	11,500 PSI 790 bar	0.63	3.24" (82.3)	2.62" (66.5)	0.75" (19.1)	0.81" (20.6)
LPBC6	3/8" SL/P Tube	7,500 PSI 520 bar	1.70	4.44" (112.8)	3.50" (88.9)	1.38" (35.1)	1.38" (35.1)
LPBC8	1/2" L/P Tube	5,500 PSI 380 bar	3.40	4.67" (118.6)	3.50" (88.9)	1.38" (35.1)	1.38" (35.1)

To order a valve with a cracking pressure other than the standard 15 PSI, add the cracking pressure to the end of the catalog number. Example: A LPBC8 with 50 PSI cracking pressure would be ordered as **LPBC8-50**.

Cracking pressures available up to 100 PSI (7 bar)

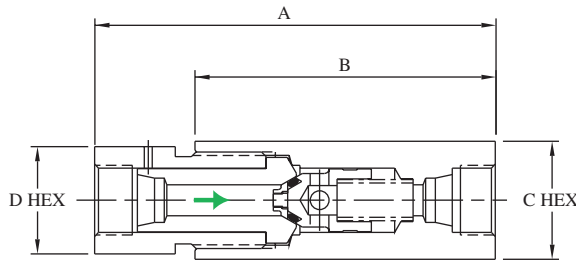

BuTech o-ring check valves reliably prevent backflow where leak-tight shutoff for liquids or gases is required. Standard materials of construction are 316 stainless steel with Buna-N o-ring and 300 series stainless steel spring.

Cracking pressure: 15 PSI (1 bar) approximate
 Operating Temperature Ranges:

O-ring Material	Operating Temperature Range	Catalog Suffix
Buna-N	-65° to +250°F (-54° to +121°C)	----
Viton	-40° to +500°F (-40° to +260°C)	-VA
Teflon	-320° to +400°F (-195° to +204°C)	-TFE
Kalrez	-20° to +550°F (-29° to +288°C)	-HT

O-RING CHECK VALVES

Catalog Number	Connection	MAWP	Cv	A	B	C	D
LPSC2	1/8" L/P Tube	15,000 PSI 1030 bar	0.15	2.38" (60.5)	1.88" (47.8)	0.50" (12.7)	0.62" (15.7)
LPSC4	1/4" SL/P Tube	11,500 PSI 790 bar	0.63	3.31" (84.1)	2.62" (66.5)	0.75" (19.1)	0.81" (20.6)
LPSC6	3/8" SL/P Tube	7,500 PSI 520 bar	1.70	4.44" (112.8)	3.50" (88.9)	1.38" (35.1)	1.38" (35.1)
LPSC8	1/2" L/P Tube	5,500 PSI 380 bar	3.40	4.67" (118.6)	3.50" (88.9)	1.38" (35.1)	1.38" (35.1)

To order a valve with a cracking pressure other than the standard 15 PSI, add the cracking pressure to the end of the catalog number. Example: A LPSC4 with 40 PSI cracking pressure would be ordered as **LPSC4-40**.

Cracking pressures available up to 100 PSI (7 bar)

All dimensions are for reference only and are subject to change.
 Dimensions in parentheses are millimeters (mm)

LOW PRESSURE FILTERS

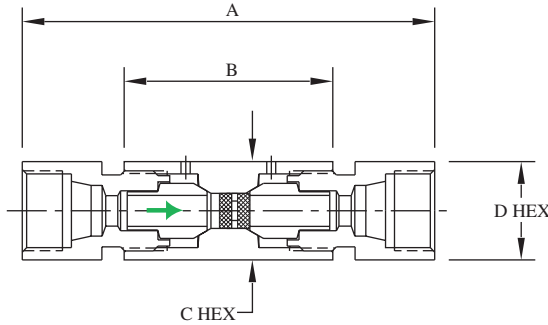

BuTech line filters are used in system lines to remove contaminating particles from the system fluid. Upstream filter of larger micron rating than downstream filter to prevent clogging of downstream filter.

Standard materials of construction are 316 stainless steel with 300 series stainless steel filter discs. Available in nominal ratings of: 0.5, 2, 5, 10, 20, 40, and 100 micron.

LINE FILTERS

Catalog Number	Connection	MAWP	Area*	A	B	C	D
LPLF2	1/8" L/P Tube	15,000 PSI 1030 bar	0.06 in ² 39 mm ²	3.62" (91.9)	1.75" (44.5)	0.75" (19.1)	0.62" (15.7)
LPLF4	1/4" L/P Tube	11,500 PSI 790 bar	0.15 in ² 97 mm ²	4.12" (104.6)	2.12" (53.8)	1.00" (25.4)	0.88" (22.4)
LPLF6	3/8" L/P Tube	7,500 PSI 520 bar	0.15 in ² 97 mm ²	4.12" (104.6)	2.12" (53.8)	1.00" (25.4)	0.88" (22.4)
LPLF8	1/2" L/P Tube	5,500 PSI 380 bar	0.15 in ² 97 mm ²	4.19" (106.4)	2.12" (53.8)	1.00" (25.4)	1.00" (25.4)

*Effective area of filter element

Micron rating of filter must be specified. To order, complete the catalog number with the desired micron rating, upstream first:

LPLF4-40/20

specifies a line filter with 1/4" L/P connections, a 40 micron filter upstream and 20 micron downstream.

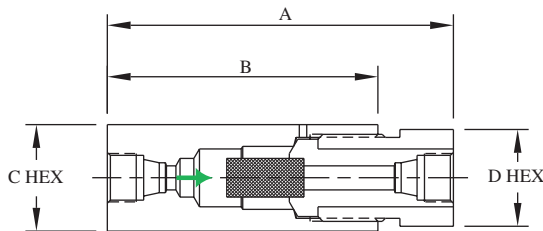

BuTech sintered cup filters offer maximum filtration surface area for removal of contaminating particles from the fluid system. They may be used in systems which require high flow rates with minimum pressure drop.

Standard materials of construction are 316 stainless steel with 300 series stainless steel filter discs. Available in nominal ratings of: 5, 10, 20, 40, and 100 micron.

SINTERED CUP FILTERS

Catalog Number	Connection	MAWP	Area*	A	B	C	D
LPSCF2	1/8" L/P Tube	15,000 PSI 1030 bar	0.54 in ² 348 mm ²	2.38" (60.5)	1.88" (47.8)	0.50" (12.7)	0.62" (15.7)
LPSCF4	1/4" SL/P Tube	11,500 PSI 790 bar	0.49 in ² 316 mm ²	3.24" (82.3)	2.62" (66.5)	0.75" (19.1)	0.81" (20.6)
LPSCF6	3/8" SL/P Tube	7,500 PSI 520 bar	1.47 in ² 948 mm ²	4.44" (112.8)	3.50" (88.9)	1.38" (35.1)	1.38" (35.1)
LPSCF8	1/2" L/P Tube	5,500 PSI 380 bar	1.47 in ² 948 mm ²	4.67" (118.6)	3.50" (88.9)	1.38" (35.1)	1.38" (35.1)

*Effective area of filter element

Micron rating of filter must be specified. To order, complete the catalog number with the desired micron rating:

LPSCF4-20

specifies a line filter with 1/4" L/P connections and a 20 micron filter.



All dimensions are for reference only and are subject to change.
Dimensions in parentheses are millimeters (mm)

LOW PRESSURE SAFETY HEADS & RUPTURE DISCS

BuTech safety head assemblies serve as holders for standard rupture discs (sold separately). Safety heads with rupture discs are used as simple and inexpensive overpressure relief devices. System pressure is relieved as a result of rupture of the replaceable disc.

The safety head assemblies shown are designed for use in high pressure systems up to 15,000 PSI (1030 bar). They can be installed directly into any of our standard couplings, elbows, tees, or crosses. Their versatility also allows direct installation into a standard 3-way valve. The result is a combination valve/safety head with beneficial cost and space advantages.

Standard material of construction is 316 stainless steel.

Safety head assemblies and rupture discs are available in two styles:

The **1/4A** style features a 1/4" blow-out diameter, an angular seat and can be ordered in pressures from 900 to 60,000 PSI (62 to 4140 bar)

The **1/2F** style features a 1/2" blow-out diameter, a flat seat and can be ordered in pressures from 500 to 10,000 PSI (34 to 689 bar). This style also has a reversible hold-down ring which greatly reduces the possibility of premature disc failure associated with installation errors inherent in some designs.

Rupture discs are available in a wide range of burst ratings. Factors such as corrosion, fatigue and temperature may affect the burst pressure of the disc and cause premature failure. This problem may sometimes be overcome by frequent replacement of the disc. All discs rated over 500 PSI (34 bar) have a manufacturing tolerance of 3% under to 6% over the specified rupture pressure rating.

Rupture Discs are not included in the safety head assembly. To order discs separately, use the following part numbering system:

Style	Material	Pressure:
4=1/4" Angled	AL=Aluminum	List desired pressure at 72°F
8=1/2" Flat	IN=Inconel	(21°C) in KSI.
	MO=Monel	
	NI=Nickel	
	SI=Silver	
	SS=316SS	
	TI=Titanium	

Examples:

An Inconel disc rated for 12,000 PSI in 1/4" Angled style would be ordered as **4IN12.00**

An Aluminum disc rated for 750 PSI in 1/2" Flat style would be ordered as **8AL0.75**

SAFETY HEADS - 1/4" ANGLED DISC

Catalog Number	Connection	MAWP	A	B	C	Discharge
LPSH2-1/4A	1/8" L/P Tube	15,000 PSI 1030 bar	1.00" (25.4)	2.83" (71.9)	1.00" (25.4)	3/8" FNPT
LPSH4-1/4A	1/4" SL/P Tube	11,500 PSI 790 bar	1.00" (25.4)	2.81" (71.4)	1.00" (25.4)	3/8" FNPT
LPSH6-1/4A	3/8" SL/P Tube	7,500 PSI 520 bar	1.00" (25.4)	2.76" (70.1)	1.00" (25.4)	3/8" FNPT
LPSH8-1/4A	1/2" L/P Tube	5,500 PSI 380 bar	1.00" (25.4)	2.87" (72.9)	1.00" (25.4)	3/8" FNPT

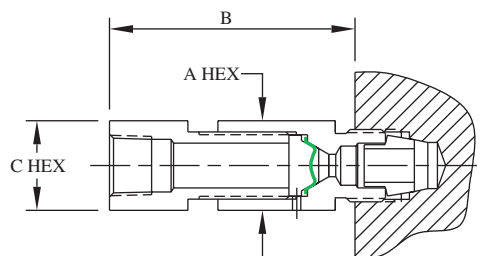

SAFETY HEADS - 1/2" FLAT DISC

Catalog Number	Connection	MAWP	A	B	C	Discharge
LPSH2-1/2F	1/8" L/P Tube	10,000 PSI 689 bar	1.00" (25.4)	2.62" (66.5)	1.00" (25.4)	3/8" FNPT
LPSH4-1/2F	1/4" SL/P Tube	10,000 PSI 689 bar	1.00" (25.4)	2.87" (72.9)	1.00" (25.4)	3/8" FNPT
LPSH6-1/2F	3/8" SL/P Tube	7,500 PSI 520 bar	1.00" (25.4)	2.87" (72.9)	1.00" (25.4)	3/8" FNPT
LPSH8-1/2F	1/2" L/P Tube	5,500 PSI 380 bar	1.00" (25.4)	2.68" (68.1)	1.00" (25.4)	3/8" FNPT

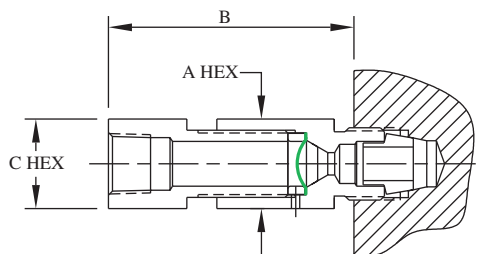

All dimensions are for reference only and are subject to change.
Dimensions in parentheses are millimeters (mm)

MEDIUM PRESSURE VALVES, FITTINGS AND TUBING

BuTech Medium Pressure Valves are designed for liquid and gas flow control in petroleum, chemical, power generating and general industrial applications.

Available in a variety of body styles, the valves are designed for operation at temperatures ranging from -100° to +600°F (-73° to +315°C). Optional packings and/or extended stuffing boxes increase the range to -423° to +1200°F (-253° to +648°C).

Their rugged construction provides assurance of fail-safe operation at pressures ranging to 20,000 PSI (1380 bar).

Needle Valve Features:

- Non-rotating stem prevents galling and scoring
- Five stem styles:
 - Vee
 - Metering
 - Regulating
 - Micro-Metering
 - Soft Tip
- 17-4PH Stem for longer service life. 316 wetted parts are also available by specifying option **-316WP** (see page MP-3)
- Glass-filled Teflon packing for temperatures to 600°F (315°C)
- Integral through holes for bracket mounting, a panel-mounting option is also available (see page MP-3)
- Wide range of options allow customizing of valve
- Positive gland locking device

Materials of Construction

Standard materials of construction include 316 cold-worked stainless steel, 17-4PH, Ampco 45, and glass-filled teflon. All BuTech equipment may also be produced in any machinable metal. Some of the more common exotic materials used are:

- Hastelloy™
- Inconel™
- Titanium
- Monel 400™

Tube Sizes: 1/4" through 1"
Pressures to 20,000 PSI (1380 bar)
Type: M/P Cone-and-Thread

Tube O.D.	Connection	Orifice	Cv*	MAWP+
1/4"	1/4" M/P	0.109" (2.8)	0.31	20,000 PSI 1380 bar
3/8"	3/8" M/P	0.203" (5.2)	0.75	20,000 PSI 1380 bar
9/16"	9/16" M/P	0.312" (7.9)	1.75	20,000 PSI 1380 bar
3/4"	3/4" M/P	0.438" (11.1)	2.80	20,000 PSI 1380 bar
1"	1" M/P	0.562" (14.3)	5.20	20,000 PSI 1380 bar

*Cv values listed are for 2-way straight pattern valves excluding metering valves.

For 2-way angle pattern valves, increase Cv value by 50%.

For Metering Valves: Cv=.004, Port size=0.062" (1.57 mm)

+Maximum allowable working pressure at 72° F (22° C)

Equipment	Page
Anti-Vibration Glands	MP-13
Bulkhead Couplings	MP-11
Caps	MP-13
Check Valves	MP-14
Collars	MP-13
Couplings	MP-11
Crosses	MP-10
Elbows	MP-10
Filters	MP-15
Glands	MP-13
Metering and Needle Valves, 1/4"	MP-4
Metering and Needle Valves, 3/8"	MP-5
Needle Valves, 9/16"	MP-6
Needle Valves, 3/4"	MP-7
Needle Valves, 1"	MP-8
Nipples	MP-12
Options	MP-3
Plugs	MP-13
Safety Heads	MP-16
Tees	MP-10
Tubing	MP-12

Collars and Glands included with all valves and fittings

All dimensions are for reference only and are subject to change.
 Dimensions in parentheses are millimeters (mm)



ORDERING INFORMATION & REPLACEMENT PARTS

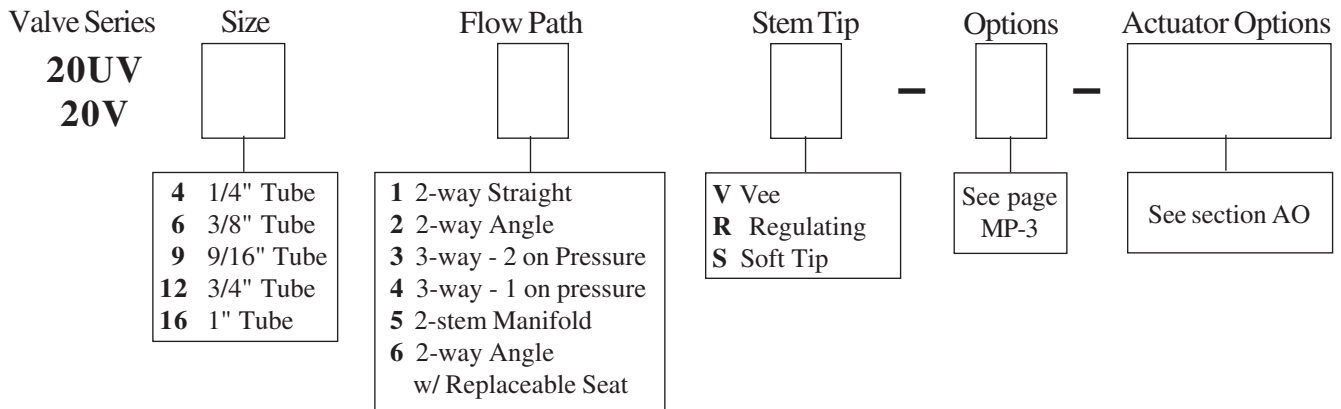

Examples:

20UV42V specifies a 2-way angle valve for 1/4" tube with a Vee stem

20UV91R-PM specifies a 2-way straight valve for 9/16" tube with regulating stem and panel-mount packing gland option

Replacement Parts

BuTech offers replacement parts in a variety of packages so you can purchase just the parts you need.

Replacement Stem Kit contains just the stem

Replacement Packing Kit contains all soft packing rings

Repair Kits contain stem, stem sleeve, stem nuts and washers, packings and packing washers (replacement seat where applicable)

Valve Series	Repair Kits		Replacement Stem	Replacement Packings	Replacement Valve Body
	All others	Replaceable Seat			
20UV4	RK-20UV4*	RK-20UV46*	20S4*	20PK4*	20UV4+
20UV6	RK-20UV6*	RK-20UV66*	20S6*	20PK6*	20UV6+
20UV9	RK-20UV9*	RK-20UV96*	20S9*	20PK9*	20UV9+
20V12	RK-20V12*	RK-20V126*	20S12*	20PK12*	20V12+
20V16	RK-20V16*	RK-20V166*	20S16*	20PK16*	20V16+

*Complete catalog number by adding the following:

V, R or S for stem type

Suffix for special packing materials (see page MP-3)
(ex. **-GR** for Grafoil packings)

Suffix for special materials
(ex. **-HC** for Hastelloy)

-LT or **-HT** for cryogenic or high-temperature service

-WAO for a valve fitted with an actuator

+Complete catalog number by adding the flow path designator:

- 1 2-way straight
- 2 2-way angle
- 3 3-way, 2 connections on pressure
- 4 3-way, 1 connection on pressure
- 5 2-stem manifold
- 6 2-way angle with replaceable seat

NEEDLE VALVE OPTIONS

Packing and Stem Materials

- GR Grafoil packings for service to 800°F (426°C)
- TFE Virgin Teflon packing for service to 450°F (232°C)
- 316WP 316 wetted parts
- STS Stellite tipped stem
- SRS Stellite replaceable seat (Replaceable seat valves only)

Handle Options

- PH Round plastic handle in place of aluminum (available on 1/4" through 9/16" sizes)
- SS Stainless steel handle in place of aluminum (available on 1/4" through 9/16" sizes, on 3/4" and 1" SS is standard)
- EXT_ Handle extended above valve body, specify number of inches of extra height desired (Ex: **EXT6** is a 6" extension)

Security Options

- HLD Handle locking device (prevents unauthorized opening/closing of valve)
- SLD Stem locking device (prevents stem from turning due to vibration)

Extreme Service

- AVG Anti-vibration glands instead of standard glands for applications with excessive vibration or shock
- O2 Cleaned for oxygen service
- SOG For Sour Gas service in accordance with NACE MR-01-75 (See Section OF for details)
- HT Extended stuffing box, graphite packing, and materials for high-temperature service to 1200°F (648°C)
- HTF Finned extended stuffing box, graphite packing, and materials for high-temperature service to 1200°F (648°C)
- LT Extended stuffing box, teflon packing, and materials for cryogenic service to -423°F (-251°C)
- LTF Finned extended stuffing box, teflon packing, and materials for cryogenic service to -423°F (-251°C)

Valve Model	A
20UV4	5.82" (147.8)
20UV6	5.82" (147.8)
20UV9	7.22" (183.4)
20V12	10.12" (257.0)
20V16	10.76" (273.3)

-HT or -LT Options

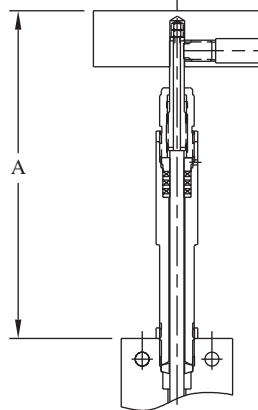

Cylindrical Bonnet

-HTF or -LTF Options

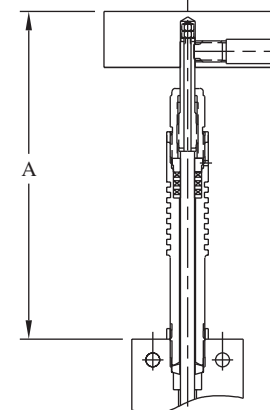

Finned Bonnet

Panel Mount

- PM Panel-mount packing gland

Valve Model	Panel Hole Size	Max Panel Thickness	H
20UV4	0.66" (16.8)	0.25" (6.4)	0.54" (13.7)
20UV6	0.66" (16.8)	0.25" (6.4)	0.54" (13.7)
20UV9	0.78" (19.8)	0.44" (11.2)	0.50" (12.7)
20V12	1.03" (26.2)	0.37" (9.4)	0.98" (24.9)
20V16	1.41" (35.8)	0.62" (15.7)	0.97" (24.6)

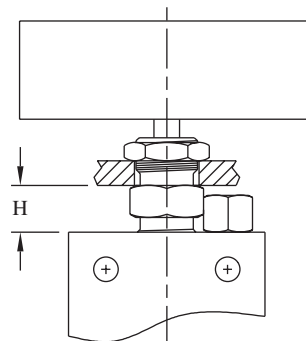

All dimensions are for reference only and are subject to change.
Dimensions in parentheses are millimeters (mm)

NEEDLE VALVES FOR 20,000 PSI (1380 BAR)

1/4" M/P TUBE, CONED AND THREADED

2-way Straight

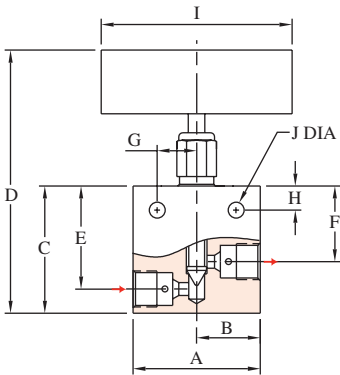

Figure 1

2-way Angle

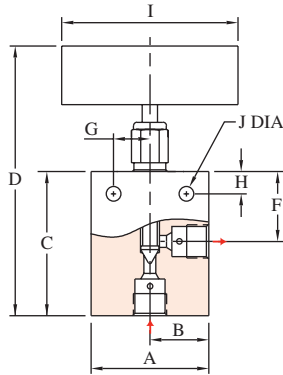

Figure 2

3-way Two on Pressure

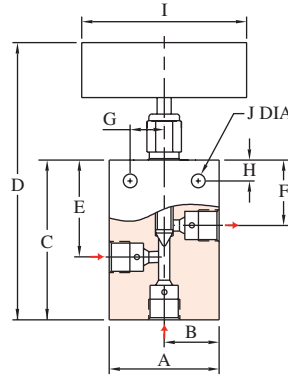

Figure 3

3-way One on Pressure

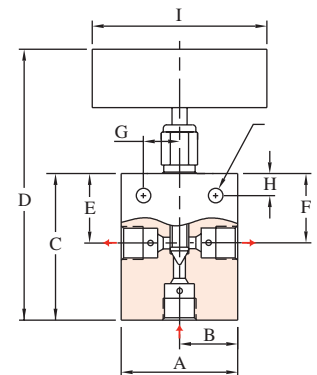

Figure 4

Catalog Number	Stem Style	Connection	A	B	C	D	E	F	G	H	I	J	K	L	Thk.	Fig
20UV41V	Vee	1/4" M/P	2.00"	1.00"	2.00"	4.50"	1.62"	1.19"	0.62"	0.38"	3.00"	0.25"	---	---	0.75"	1
20UV41R	Reg	Tube	(50.8)	(25.4)	(50.8)	(114.3)	(41.1)	(30.2)	(15.7)	(9.7)	(76.2)	(6.4)	---	---	(19.1)	
20UV42V	Vee	1/4" M/P	2.00"	1.00"	2.44"	4.94"	---	1.19"	0.62"	0.38"	3.00"	0.25"	---	---	0.75"	2
20UV42R	Reg	Tube	(50.8)	(25.4)	(62.0)	(125.5)	---	(30.2)	(15.7)	(9.7)	(76.2)	(6.4)	---	---	(19.1)	
20UV43V	Vee	1/4" M/P	2.00"	1.00"	2.62"	5.12"	1.62"	1.19"	0.62"	0.38"	3.00"	0.25"	---	---	0.75"	3
20UV43R	Reg	Tube	(50.8)	(25.4)	(66.5)	(130.0)	(41.1)	(30.2)	(15.7)	(9.7)	(76.2)	(6.4)	---	---	(19.1)	
20UV44V	Vee	1/4" M/P	2.00"	1.00"	2.44"	4.94"	1.19"	1.19"	0.62"	0.38"	3.00"	0.25"	---	---	0.75"	4
20UV44R	Reg	Tube	(50.8)	(25.4)	(62.0)	(125.5)	(30.2)	(30.2)	(15.7)	(9.7)	(76.2)	(6.4)	---	---	(19.1)	
20UV45V	Vee	1/4" M/P	2.00"	1.00"	3.38"	8.38"	1.68"	1.19"	0.62"	0.38"	3.00"	0.25"	---	---	0.75"	5
20UV45R	Reg	Tube	(50.8)	(25.4)	(85.9)	(212.9)	(42.7)	(30.2)	(15.7)	(9.7)	(76.2)	(6.4)	---	---	(19.1)	
20UV46V	Vee	1/4" M/P	2.00"	1.00"	2.25"	4.75"	---	1.19"	0.62"	0.38"	3.00"	0.25"	0.75"	1.06"	0.75"	6
20UV46R	Reg	Tube	(50.8)	(25.4)	(57.2)	(120.7)	---	(30.2)	(15.7)	(9.7)	(76.2)	(6.4)	(19.1)	(26.9)	(19.1)	
20MV46V	Meter	1/4" M/P	2.00"	1.00"	2.62"	6.72"	---	1.31"	0.69"	0.38"	3.00"	0.25"	0.75"	1.06"	1.00"	7
		Tube	(50.8)	(25.4)	(66.5)	(170.7)	---	(33.3)	(17.5)	(9.7)	(76.2)	(6.4)	(19.1)	(26.9)	(25.4)	
20MMV46V	Micro-Meter	1/4" M/P	2.00"	1.00"	2.62"	7.36"	---	1.31"	0.69"	0.38"	2.35"	0.25"	0.75"	1.06"	1.00"	8
		Tube	(50.8)	(25.4)	(66.5)	(186.9)	---	(33.3)	(17.5)	(9.7)	(59.7)	(6.4)	(19.1)	(26.9)	(25.4)	

See page MP-1 for orifice and Cv

2-stem Manifold

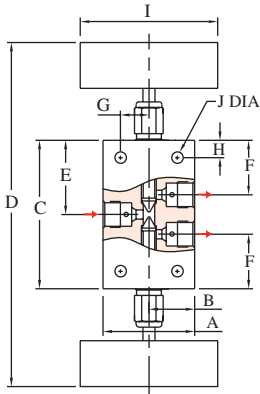

Figure 5

Replaceable Seat

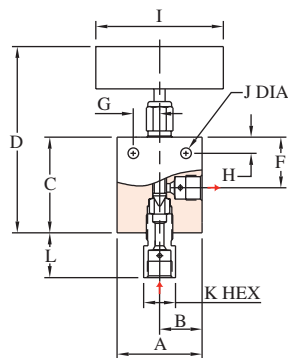

Figure 6

Metering

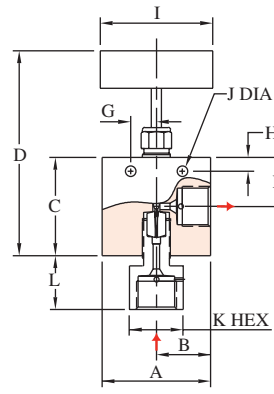

Figure 7

Micro-Metering

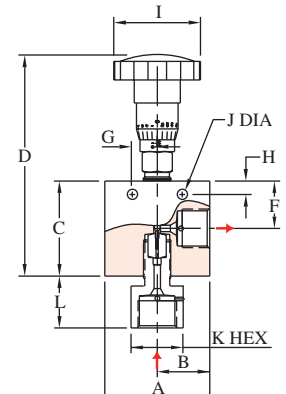

Figure 8

All dimensions are for reference only and are subject to change.
Dimensions in parentheses are millimeters (mm)

NEEDLE VALVES FOR 20,000 PSI (1380 BAR)

3/8" M/P TUBE, CONED AND THREADED

2-way Straight

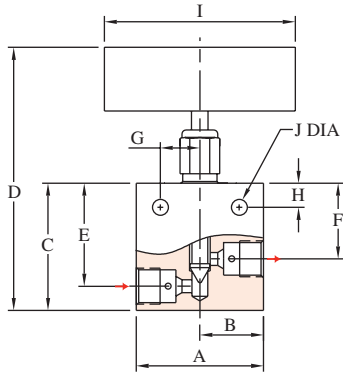

Figure 1

2-way Angle

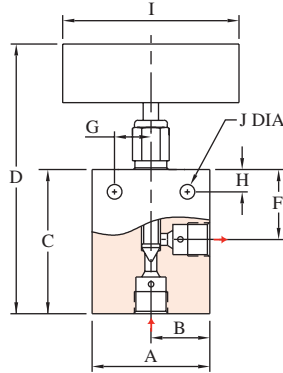

Figure 2

3-way Two on Pressure

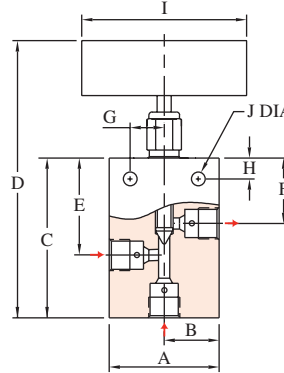

Figure 3

3-way One on Pressure

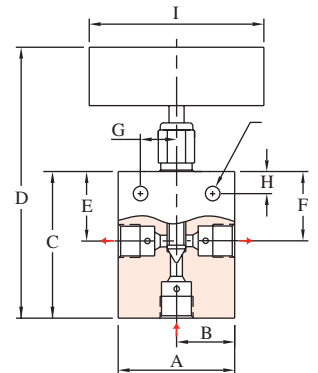

Figure 4

Catalog Number	Stem Style	Connection	A	B	C	D	E	F	G	H	I	J	K	L	Thk.	Fig
20UV61V	Vee	3/8" M/P	2.00"	1.00"	2.00"	4.50"	1.62"	1.19"	0.62"	0.38"	3.00"	0.25"	---	---	0.75"	1
20UV61R	Reg	Tube	(50.8)	(25.4)	(50.8)	(114.3)	(41.1)	(30.2)	(15.7)	(9.7)	(76.2)	(6.4)	---	---	(19.1)	
20UV62V	Vee	3/8" M/P	2.00"	1.00"	2.44"	4.94"	---	1.19"	0.62"	0.38"	3.00"	0.25"	---	---	0.75"	2
20UV62R	Reg	Tube	(50.8)	(25.4)	(62.0)	(125.5)	---	(30.2)	(15.7)	(9.7)	(76.2)	(6.4)	---	---	(19.1)	
20UV63V	Vee	3/8" M/P	2.00"	1.00"	2.62"	5.12"	1.62"	1.19"	0.62"	0.38"	3.00"	0.25"	---	---	0.75"	3
20UV63R	Reg	Tube	(50.8)	(25.4)	(66.5)	(130.0)	(41.1)	(30.2)	(15.7)	(9.7)	(76.2)	(6.4)	---	---	(19.1)	
20UV64V	Vee	3/8" M/P	2.00"	1.00"	2.44"	4.94"	1.19"	1.19"	0.62"	0.38"	3.00"	0.25"	---	---	0.75"	4
20UV64R	Reg	Tube	(50.8)	(25.4)	(62.0)	(125.5)	(30.2)	(30.2)	(15.7)	(9.7)	(76.2)	(6.4)	---	---	(19.1)	
20UV65V	Vee	3/8" M/P	2.00"	1.00"	3.38"	8.38"	1.68"	1.19"	0.62"	0.38"	3.00"	0.25"	---	---	0.75"	5
20UV65R	Reg	Tube	(50.8)	(25.4)	(85.9)	(212.9)	(42.7)	(30.2)	(15.7)	(9.7)	(76.2)	(6.4)	---	---	(19.1)	
20UV66V	Vee	3/8" M/P	2.00"	1.00"	2.25"	4.75"	---	1.19"	0.62"	0.38"	3.00"	0.25"	0.75"	1.06"	0.75"	6
20UV66R	Reg	Tube	(50.8)	(25.4)	(57.2)	(120.7)	---	(30.2)	(15.7)	(9.7)	(76.2)	(6.4)	(19.1)	(26.9)	(19.1)	
20MV66V	Meter	3/8" M/P	2.00"	1.00"	2.62"	6.72"	---	1.31"	0.69"	0.38"	3.00"	0.25"	0.75"	1.06"	1.00"	7
		Tube	(50.8)	(25.4)	(66.5)	(170.7)	---	(33.3)	(17.5)	(9.7)	(76.2)	(6.4)	(19.1)	(26.9)	(25.4)	
20MMV66V	Micro-Meter	3/8" M/P	2.50"	1.25"	2.62"	7.36"	---	1.31"	0.69"	0.38"	2.35"	0.25"	0.75"	1.06"	1.00"	8
		Tube	(63.5)	(31.8)	(66.5)	(186.9)	---	(33.3)	(17.5)	(9.7)	(59.7)	(6.4)	(19.1)	(26.9)	(25.4)	

See page MP-1 for orifice and Cv

2-stem Manifold

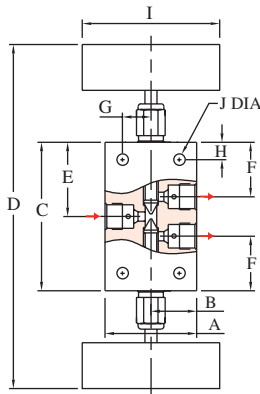

Figure 5

Replaceable Seat

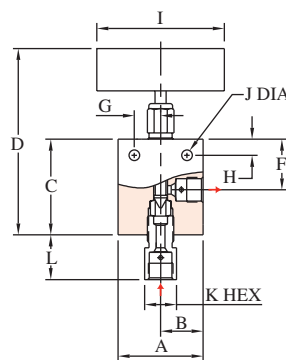

Figure 6

Metering

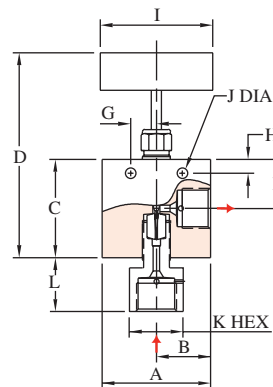

Figure 7

Micro-Metering

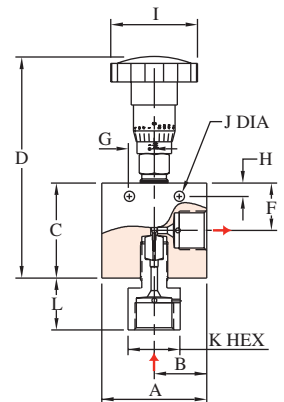

Figure 8

All dimensions are for reference only and are subject to change.
Dimensions in parentheses are millimeters (mm)

NEEDLE VALVES FOR 20,000 PSI (1380 BAR)

9/16" M/P TUBE, CONED AND THREADED

2-way Straight

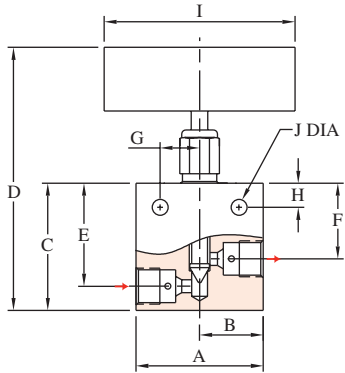

Figure 1

2-way Angle

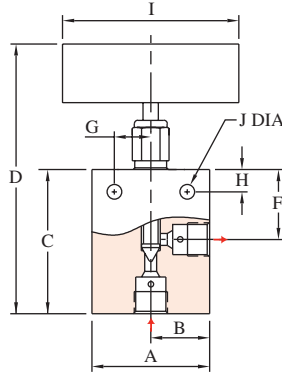

Figure 2

3-way Two on Pressure

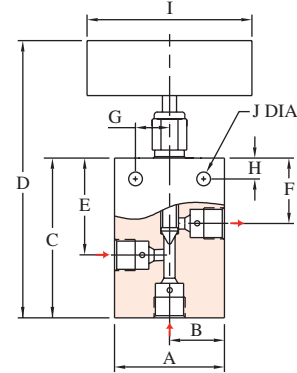

Figure 3

Catalog Number	Stem Style	Connection	A	B	C	D	E	F	G	H	I	J	K	L	Thk.	Fig
20UV91V	Vec	9/16" M/P	2.50"	1.25"	2.88"	6.32"	2.38"	1.75"	0.69"	0.50"	4.00"	0.34"	---	---	1.00"	1
20UV91R	Reg	Tube	(63.5)	(31.8)	(73.2)	(160.5)	(60.5)	(44.5)	(17.5)	(12.7)	(101.6)	(8.6)	---	---	(25.4)	
20UV92V	Vec	9/16" M/P	2.50"	1.25"	3.38"	6.82"	---	1.75"	0.69"	0.50"	4.00"	0.34"	---	---	1.00"	2
20UV92R	Reg	Tube	(63.5)	(31.8)	(85.9)	(173.2)	---	(44.5)	(17.5)	(12.7)	(101.6)	(8.6)	---	---	(25.4)	
20UV93V	Vec	9/16" M/P	2.50"	1.25"	3.62"	7.06"	2.38"	1.75"	0.69"	0.50"	4.00"	0.34"	---	---	1.00"	3
20UV93R	Reg	Tube	(63.5)	(31.8)	(91.9)	(179.3)	(60.5)	(44.5)	(17.5)	(12.7)	(101.6)	(8.6)	---	---	(25.4)	
20UV94V	Vec	9/16" M/P	2.50"	1.25"	3.38"	6.82"	1.75"	1.75"	0.69"	0.50"	4.00"	0.34"	---	---	1.00"	4
20UV94R	Reg	Tube	(63.5)	(31.8)	(85.9)	(173.2)	(44.5)	(44.5)	(17.5)	(12.7)	(101.6)	(8.6)	---	---	(25.4)	
20UV95V	Vec	9/16" M/P	2.50"	1.25"	5.12"	12.00"	2.56"	1.75"	0.69"	0.50"	4.00"	0.34"	---	---	1.00"	5
20UV95R	Reg	Tube	(63.5)	(31.8)	(130.0)	(304.8)	(65.0)	(44.5)	(17.5)	(12.7)	(101.6)	(8.6)	---	---	(25.4)	
20UV96V	Vec	9/16" M/P	2.50"	1.25"	3.25"	6.69"	---	1.75"	0.69"	0.50"	4.00"	0.34"	0.75"	1.37"	1.00"	6
20UV96R	Reg	Tube	(63.5)	(31.8)	(82.6)	(169.9)	---	(44.5)	(17.5)	(12.7)	(101.6)	(8.6)	(19.1)	(34.8)	(25.4)	

See page MP-1 for orifice and Cv

3-way One on Pressure

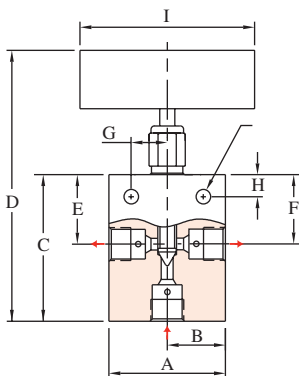

Figure 4

2-stem Manifold

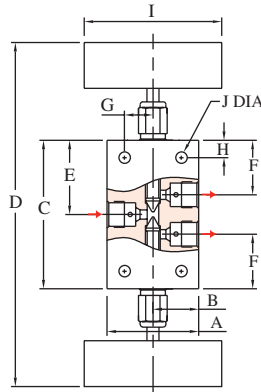

Figure 5

Replaceable Seat

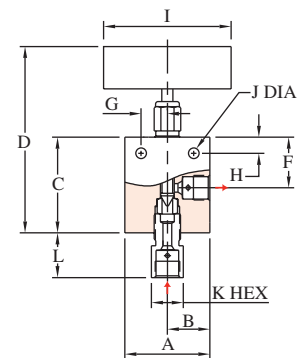

Figure 6

NEEDLE VALVES FOR 20,000 PSI (1380 BAR)

3/4" M/P TUBE, CONED AND THREADED

2-way Straight

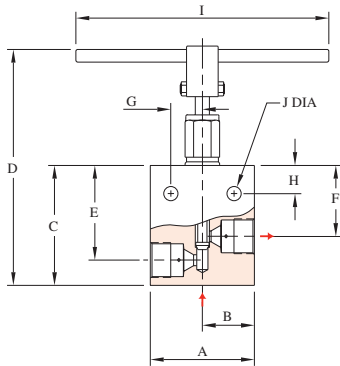

Figure 1

2-way Angle

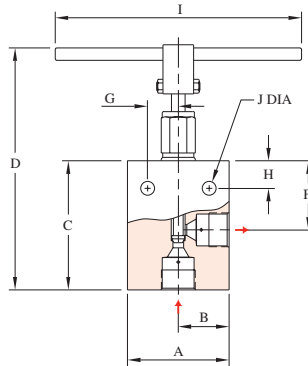

Figure 2

3-way Two on Pressure

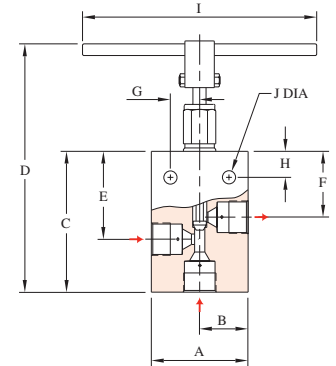

Figure 3

Catalog Number	Stem Style	Connection	A	B	C	D	E	F	G	H	I	J	K	L	Thk.	Fig
20V121V	Vee	3/4" M/P	3.00"	1.50"	3.75"	8.75"	3.00"	2.25"	0.88"	0.62"	8.00"	0.43"	---	---	1.38"	1
20V121R	Reg	Tube	(76.2)	(38.1)	(95.3)	(222.3)	(76.2)	(57.2)	(22.4)	(15.7)	(203.2)	(10.9)	---	---	(35.1)	
20V122V	Vee	3/4" M/P	3.00"	1.50"	4.50"	9.50"	---	2.25"	0.88"	0.62"	8.00"	0.43"	---	---	1.38"	2
20V122R	Reg	Tube	(76.2)	(38.1)	(114.3)	(241.3)	---	(57.2)	(22.4)	(15.7)	(203.2)	(10.9)	---	---	(35.1)	
20V123V	Vee	3/4" M/P	3.00"	1.50"	5.00"	10.00"	3.00"	2.25"	0.88"	0.62"	8.00"	0.43"	---	---	1.38"	3
20V123R	Reg	Tube	(76.2)	(38.1)	(127.0)	(254.0)	(76.2)	(57.2)	(22.4)	(15.7)	(203.2)	(10.9)	---	---	(35.1)	
20V124V	Vee	3/4" M/P	3.00"	1.50"	4.50"	9.50"	2.25"	2.25"	0.88"	0.62"	8.00"	0.43"	---	---	1.38"	4
20V124R	Reg	Tube	(76.2)	(38.1)	(114.3)	(241.3)	(57.2)	(57.2)	(22.4)	(15.7)	(203.2)	(10.9)	---	---	(35.1)	
20V125V	Vee	3/4" M/P	3.00"	1.50"	7.00"	17.00"	3.50"	2.25"	0.88"	0.62"	8.00"	0.43"	---	---	1.38"	5
20V125R	Reg	Tube	(76.2)	(38.1)	(177.8)	(431.8)	(88.9)	(57.2)	(22.4)	(15.7)	(203.2)	(10.9)	---	---	(35.1)	
20V126V	Vee	3/4" M/P	3.00"	1.50"	3.75"	8.75"	---	2.25"	0.88"	0.62"	8.00"	0.43"	1.38"	1.65"	1.38"	6
20V126R	Reg	Tube	(76.2)	(38.1)	(95.3)	(222.3)	---	(57.2)	(22.4)	(15.7)	(203.2)	(10.9)	(35.1)	(41.9)	(35.1)	

See page MP-1 for orifice and Cv

3-way One on Pressure

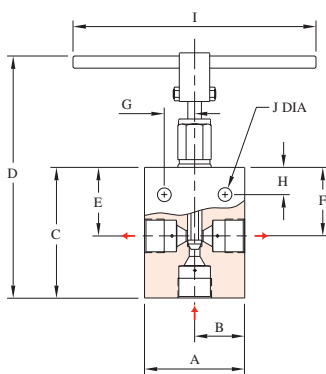

Figure 4

2-stem Manifold

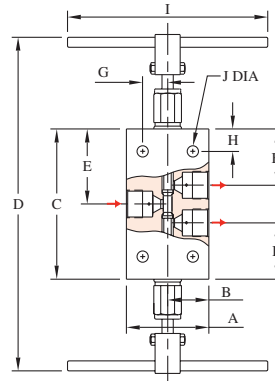

Figure 5

Replaceable Seat

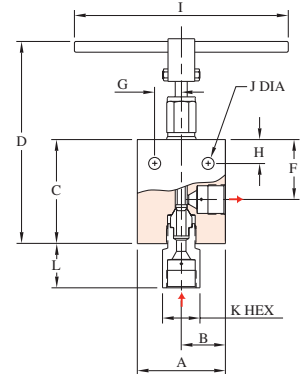

Figure 6



All dimensions are for reference only and are subject to change.
Dimensions in parentheses are millimeters (mm)



NEEDLE VALVES FOR 20,000 PSI (1380 BAR)

1" M/P TUBE, CONED AND THREADED

2-way Straight

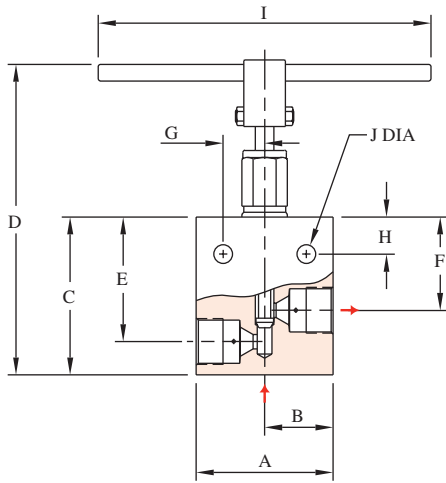

Figure 1

2-way Angle

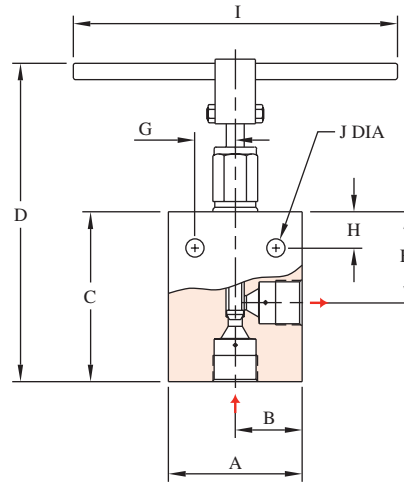

Figure 2

Catalog Number	Stem Style	Connection	A	B	C	D	E	F	G	H	I	J	Thk.	Fig
20V161V	Vee	1" M/P	4.12"	2.06"	4.75"	10.19"	3.75"	2.81"	1.25"	1.12"	10.00"	0.56"	1.75"	1
20V161R	Reg	Tube	(104.6)	(52.3)	(120.7)	(258.8)	(95.3)	(71.4)	(31.8)	(28.4)	(254.0)	(14.2)	(44.5)	
20V162V	Vee	1" M/P	4.12"	2.06"	5.50"	10.94"	---	2.81"	1.25"	1.12"	10.00"	0.56"	1.75"	2
20V162R	Reg	Tube	(104.6)	(52.3)	(139.7)	(277.9)	---	(71.4)	(31.8)	(28.4)	(254.0)	(14.2)	(44.5)	
20V163V	Vee	1" M/P	4.12"	2.06"	6.00"	11.44"	3.75"	2.81"	1.25"	1.12"	10.00"	0.56"	1.75"	3
20V163R	Reg	Tube	(104.6)	(52.3)	(152.4)	(290.6)	(95.3)	(71.4)	(31.8)	(28.4)	(254.0)	(14.2)	(44.5)	
20V164V	Vee	1" M/P	4.12"	2.06"	5.50"	10.94"	2.81"	2.81"	1.25"	1.12"	10.00"	0.56"	1.75"	4
20V164R	Reg	Tube	(104.6)	(52.3)	(139.7)	(277.9)	(71.4)	(71.4)	(31.8)	(28.4)	(254.0)	(14.2)	(44.5)	

See page MP-1 for orifice and Cv

3-way Two on Pressure

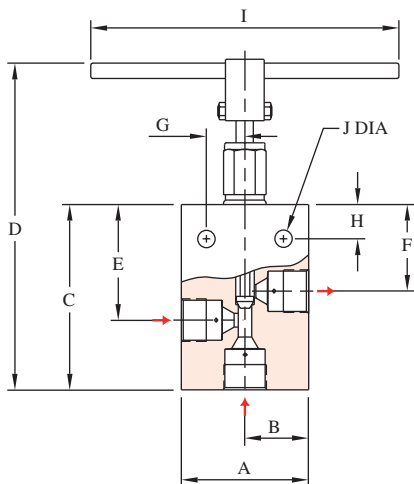

Figure 3

3-way One on Pressure

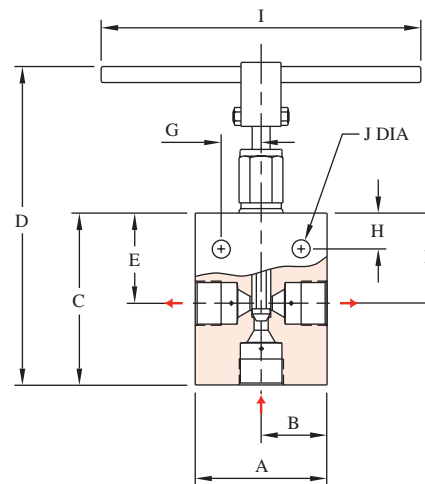

Figure 4

All dimensions are for reference only and are subject to change.
Dimensions in parentheses are millimeters (mm)

NEEDLE VALVES FOR 20,000 PSI (1380 BAR)

1" M/P TUBE, CONED AND THREADED

2-stem Manifold

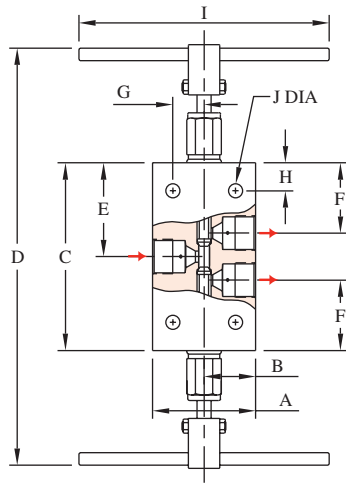

Figure 5

Replaceable Seat

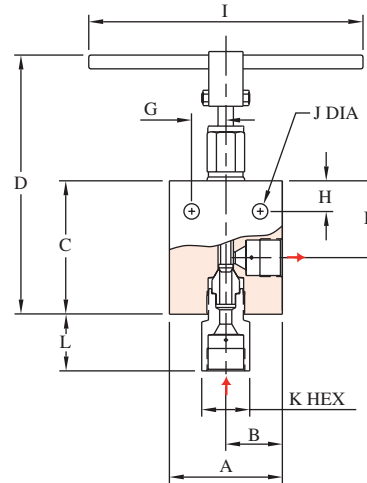

Figure 6

Catalog Number	Stem Style	Connection	A	B	C	D	E	F	G	H	I	J	K	L	Thk.	Fig
20V165V	Vee	1" M/P	4.12"	2.06"	8.00"	18.88"	4.00"	2.81"	1.25"	1.12"	10.00"	0.56"	---	---	1.75"	5
20V165R	Reg	Tube	(104.6)	(52.3)	(203.2)	(479.6)	(101.6)	(71.4)	(31.8)	(28.4)	(254.0)	(14.2)	---	---	(44.5)	
20V166V	Vee	1" M/P	4.12"	2.06"	4.88"	10.62"	---	2.81"	1.56"	1.12"	10.00"	0.56"	1.75"	2.08"	1.75"	6
20V166R	Reg	Tube	(104.6)	(52.3)	(124.0)	(269.7)	---	(71.4)	(39.6)	(28.4)	(254.0)	(14.2)	(44.5)	(52.8)	(44.5)	

See page MP-1 for orifice and Cv

All dimensions are for reference only and are subject to change.
Dimensions in parentheses are millimeters (mm)



MEDIUM PRESSURE EQUIPMENT

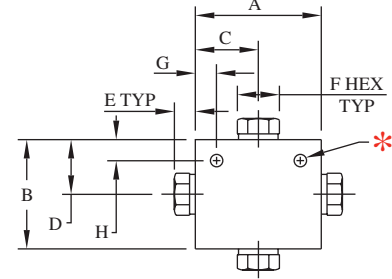
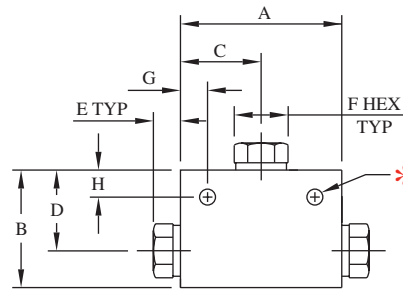
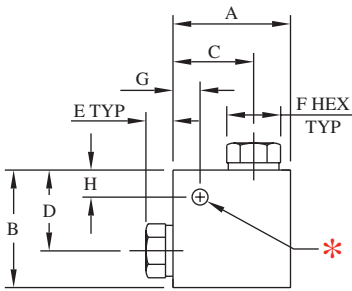

ELBOWS

Catalog Number	Connection	Port	MAWP	A	B	C	D	E	F	Block Thickness	Mounting Holes*		
											G	H	Dia.
20L4	1/4" M/P Tube	0.125" (3.2)	20,000 PSI 1380 bar	1.50" (38.1)	1.13" (28.7)	0.75" (19.1)	0.75" (19.1)	0.35" (8.9)	0.50" (12.7)	0.62" (15.7)	0.25" (6.4)	0.25" (6.4)	0.22" (5.6)
20L6	3/8" M/P Tube	0.203" (5.2)	20,000 PSI 1380 bar	2.00" (50.8)	1.38" (35.1)	1.00" (25.4)	1.00" (25.4)	0.47" (11.9)	0.63" (16.0)	0.75" (19.1)	0.31" (7.9)	0.31" (7.9)	0.22" (5.6)
20L9	9/16" M/P Tube	0.359" (9.1)	20,000 PSI 1380 bar	2.50" (63.5)	1.75" (44.5)	1.25" (31.8)	1.25" (31.8)	0.66" (16.8)	0.88" (22.4)	1.00" (25.4)	0.50" (12.7)	0.50" (12.7)	0.28" (7.1)
20L12	3/4" M/P Tube	0.515" (13.1)	20,000 PSI 1380 bar	3.00" (76.2)	2.25" (57.2)	1.50" (38.1)	1.50" (38.1)	0.55" (14.0)	1.18" (30.0)	1.38" (35.1)	0.50" (12.7)	0.50" (12.7)	0.34" (8.7)
20L16	1" M/P Tube	0.562" (14.3)	20,000 PSI 1380 bar	4.12" (104.6)	3.00" (76.2)	2.06" (52.3)	2.06" (52.3)	0.69" (17.5)	1.38" (35.1)	1.75" (44.5)	0.69" (17.5)	0.69" (17.5)	0.41" (10.4)

TEES

Catalog Number	Connection	Port	MAWP	A	B	C	D	E	F	Block Thickness	Mounting Holes*		
											G	H	Dia.
20T4	1/4" M/P Tube	0.109" (2.8)	20,000 PSI 1380 bar	1.50" (38.1)	1.13" (28.7)	0.75" (19.1)	0.75" (19.1)	0.35" (8.9)	0.50" (12.7)	0.62" (15.7)	0.25" (6.4)	0.25" (6.4)	0.22" (5.6)
20T6	3/8" M/P Tube	0.203" (5.2)	20,000 PSI 1380 bar	2.00" (50.8)	1.38" (35.1)	1.00" (25.4)	1.00" (25.4)	0.47" (11.9)	0.63" (16.0)	0.75" (19.1)	0.31" (7.9)	0.31" (7.9)	0.22" (5.6)
20T9	9/16" M/P Tube	0.359" (9.1)	20,000 PSI 1380 bar	2.50" (63.5)	1.75" (44.5)	1.25" (31.8)	1.25" (31.8)	0.66" (16.8)	0.88" (22.4)	1.00" (25.4)	0.50" (12.7)	0.50" (12.7)	0.28" (7.1)
20T12	3/4" M/P Tube	0.515" (13.1)	20,000 PSI 1380 bar	3.00" (76.2)	2.25" (57.2)	1.50" (38.1)	1.50" (38.1)	0.55" (14.0)	1.18" (30.0)	1.38" (35.1)	0.50" (12.7)	0.50" (12.7)	0.34" (8.6)
20T16	1" M/P Tube	0.562" (14.3)	20,000 PSI 1380 bar	4.12" (104.6)	3.00" (76.2)	2.06" (52.3)	2.06" (52.3)	0.69" (17.5)	1.38" (35.1)	1.75" (44.5)	0.69" (17.5)	0.69" (17.5)	0.41" (10.4)

CROSSES

Catalog Number	Connection	Port	MAWP	A	B	C	D	E	F	Block Thickness	Mounting Holes*		
											G	H	Dia.
20X4	1/4" M/P Tube	0.125" (3.2)	20,000 PSI 1380 bar	1.50" (38.1)	1.50" (38.1)	0.75" (19.1)	0.75" (19.1)	0.35" (8.9)	0.50" (12.7)	0.62" (15.7)	0.25" (6.4)	0.25" (6.4)	0.22" (5.6)
20X6	3/8" M/P Tube	0.203" (5.2)	20,000 PSI 1380 bar	2.00" (50.8)	2.00" (50.8)	1.00" (25.4)	1.00" (25.4)	0.47" (11.9)	0.63" (16.0)	0.75" (19.1)	0.38" (9.7)	0.38" (9.7)	0.25" (6.4)
20X9	9/16" M/P Tube	0.359" (9.1)	20,000 PSI 1380 bar	2.50" (63.5)	2.50" (63.5)	1.25" (31.8)	1.25" (31.8)	0.66" (16.8)	0.88" (22.4)	1.00" (25.4)	0.50" (12.7)	0.50" (12.7)	0.28" (7.1)
20X12	3/4" M/P Tube	0.515" (13.1)	20,000 PSI 1380 bar	3.00" (76.2)	3.00" (76.2)	1.50" (38.1)	1.50" (38.1)	0.55" (14.0)	1.18" (30.0)	1.38" (35.1)	0.50" (12.7)	0.50" (12.7)	0.34" (8.7)
20X16	1" M/P Tube	0.687" (17.4)	20,000 PSI 1380 bar	4.12" (104.6)	4.12" (104.6)	2.06" (52.3)	2.06" (52.3)	0.69" (17.5)	1.38" (35.1)	1.75" (44.5)	0.69" (17.5)	0.69" (17.5)	0.41" (10.3)

*Mounting holes provided when the catalog number is suffixed by "-MH" when ordering.

All dimensions are for reference only and are subject to change.
Dimensions in parentheses are millimeters (mm)



MEDIUM PRESSURE EQUIPMENT

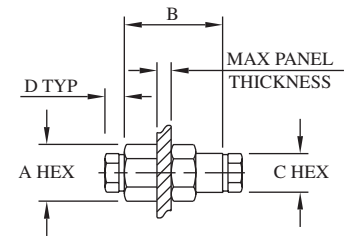
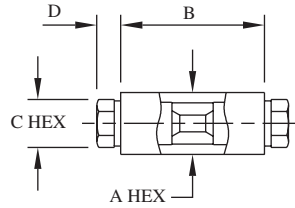
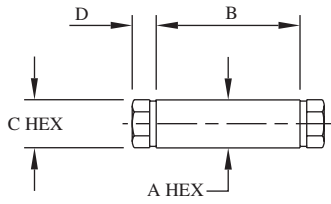

See bulkhead table below for panel hole drill size

COUPLINGS

Catalog Number	Connection	Port	MAWP	A	B	C	D
20F4	1/4" M/P Tube	0.109" (2.8)	20,000 PSI 1380 bar	0.75" (19.1)	1.50" (38.1)	0.50" (12.7)	0.35" (8.9)
20F6	3/8" M/P Tube	0.203" (5.2)	20,000 PSI 1380 bar	0.75" (19.1)	1.75" (44.5)	0.63" (16.0)	0.47" (11.9)
20F9	9/16" M/P Tube	0.312" (7.9)	20,000 PSI 1380 bar	1.00" (25.4)	2.12" (53.8)	0.88" (22.4)	0.66" (16.8)
20F12	3/4" M/P Tube	0.438" (11.1)	20,000 PSI 1380 bar	1.38" (35.1)	2.50" (63.5)	1.18" (30.0)	0.55" (14.0)
20F16	1" M/P Tube	0.562" (14.3)	20,000 PSI 1380 bar	1.75" (44.5)	3.50" (88.9)	1.38" (35.1)	0.69" (17.5)

REPLACEABLE SEAT COUPLINGS

Catalog Number	Connection	Port	MAWP	A	B	C	D
20UF4	1/4" M/P Tube	0.109" (2.8)	20,000 PSI 1380 bar	0.75" (19.1)	1.50" (38.1)	0.50" (12.7)	0.35" (8.9)
20UF6	3/8" M/P Tube	0.203" (5.2)	20,000 PSI 1380 bar	0.75" (19.1)	1.75" (44.5)	0.63" (16.0)	0.47" (11.9)
20UF9	9/16" M/P Tube	0.312" (7.9)	20,000 PSI 1380 bar	1.00" (25.4)	2.00" (50.8)	0.88" (22.4)	0.66" (16.8)
20UF12	3/4" M/P Tube	0.438" (11.1)	20,000 PSI 1380 bar	1.38" (35.1)	2.50" (63.5)	1.18" (30.0)	0.55" (14.0)
20UF16	1" M/P Tube	0.562" (14.3)	20,000 PSI 1380 bar	1.75" (44.5)	3.50" (88.9)	1.38" (35.1)	0.69" (17.5)

BULKHEADS

Catalog Number	Connection	Port	MAWP	A	B	C	D	Panel Hole	Panel Thickness
20BF4	1/4" M/P Tube	0.109" (2.8)	20,000 PSI 1380 bar	1.00" (25.4)	2.00" (50.8)	0.50" (12.7)	0.35" (8.9)	0.88" (22.4)	0.38" (9.7)
20BF6	3/8" M/P Tube	0.203" (5.2)	20,000 PSI 1380 bar	1.00" (25.4)	2.00" (50.8)	0.63" (16.0)	0.47" (11.9)	0.94" (23.9)	0.38" (9.7)
20BF9	9/16" M/P Tube	0.312" (7.9)	20,000 PSI 1380 bar	1.38" (35.1)	2.62" (66.5)	0.88" (22.4)	0.66" (16.8)	1.25" (31.8)	0.50" (12.7)
20BF12	3/4" M/P Tube	0.438" (11.1)	20,000 PSI 1380 bar	1.88" (47.8)	2.62" (66.5)	1.18" (30.0)	0.55" (14.0)	1.69" (42.9)	0.38" (9.7)
20BF16	1" M/P Tube	0.562" (14.3)	20,000 PSI 1380 bar	2.12" (53.8)	3.50" (88.9)	1.38" (35.1)	0.69" (17.5)	2.00" (50.8)	0.50" (12.7)

All dimensions are for reference only and are subject to change.
Dimensions in parentheses are millimeters (mm)



MEDIUM PRESSURE NIPPLES AND TUBING

Coned and Threaded Nipples

BuTech stocks pre-cut coned and threaded nipples in lengths up to 12" (305 mm). In addition, nipples can be purchased to any custom length.

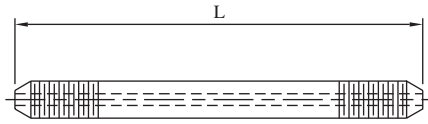

Connection	Length							MAWP
	2.75" (69.9)	3.00" (76.2)	4.00" (101.6)	6.00" (152.4)	8.00" (203.2)	10.00" (254.0)	12.00" (304.8)	
1/4" M/P	20N442-*	20N443-*	20N444-*	20N446-*	20N448-*	20N4410-*	20N4412-*	20,000 PSI 1380 bar
3/8" M/P		20N663-*	20N664-*	20N666-*	20N668-*	20N6610-*	20N6612-*	20,000 PSI 1380 bar
9/16" M/P			20N994-*	20N996-*	20N998-*	20N9910-*	20N9912-*	20,000 PSI 1380 bar
3/4" M/P				20N126-*	20N128-*	20N1210-*	20N1212-*	20,000 PSI 1380 bar
1" M/P				20N166-*	20N168-*	20N1610-*	20N1612-*	20,000 PSI 1380 bar

*Complete catalog number by adding suffix **316** for 316 stainless steel or suffix **304** for 304 stainless steel

Tubing

Catalog Number	Connection	O.D.	I.D.	MAWP
20-109-*	1/4" M/P	0.250" (6.4)	0.109" (2.8)	20,000 PSI 1380 bar
20-203-*	3/8" M/P	0.375" (9.5)	0.203" (5.2)	20,000 PSI 1380 bar
20-312-*	9/16" M/P	0.562" (14.3)	0.312" (7.9)	20,000 PSI 1380 bar
20-438-*	3/4" M/P	0.750" (19.1)	0.438" (11.1)	20,000 PSI 1380 bar
20-562-*	1" M/P	1.000" (25.4)	0.562" (14.3)	20,000 PSI 1380 bar

*Complete catalog number by adding suffix **316** for 316 stainless steel or suffix **304** for 304 stainless steel. Other materials are also available, please consult factory.

BuTech offers a complete selection of austenitic seamless cold-drawn stainless steel tubing for high pressure applications where both high strength and corrosion resistance are desired. Tubing is available in standard 20-24 foot lengths (6-7 meters), however, longer lengths are available on request.



See Section T for Coning Tools, Threading Tools and Tube Vises!

MEDIUM PRESSURE CONNECTION COMPONENTS

Connection Components

All BuTech valves and fittings are supplied with glands and collars. To order these components separately, use catalog numbers listed below. When using a plug, the collar is not required.

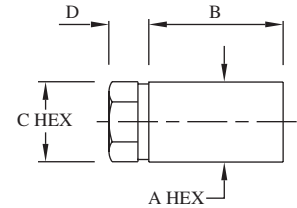

Tube Size	Collar	Gland	Plug
1/4" M/P	20C4	20G4	20P4
3/8" M/P	20C6	20G6	20P6
9/16" M/P	20C9	20G9	20P9
3/4" M/P	20C12	20G12	20P12
1" M/P	20C16	20G16	20P16

Cap	A	B	C	D
20CA4	0.63" (16.0)	1.00" (25.4)	0.50" (12.7)	0.35" (8.9)
20CA6	0.75" (19.1)	1.25" (31.8)	0.63" (16.0)	0.47" (11.9)
20CA9	1.00" (25.4)	1.50" (38.1)	0.88" (22.4)	0.66" (16.8)
20CA12	1.38" (35.1)	1.75" (44.5)	1.18" (30.0)	0.55" (14.0)
20CA16	1.75" (44.5)	2.25" (57.2)	1.38" (35.1)	0.69" (17.5)

Anti-Vibration Collet Glands

In standard high pressure connection systems, the bending stresses imposed by excessive vibration or shock on the the threaded area of the tubing may cause premature fatigue failure at the back of the thread. By using a BuTech Anti-Vibration Collet Gland, the stress concentration is transferred back to the unthreaded section of the tubing. This transfer and the spring-type gripping action of the collet, strengthens the entire assembly, resulting in virtually unlimited vibration fatigue life. Anti-Vibration Collet Glands are recommended whenever locating a valve or fitting on an unsupported line near a compressor, on equipment subjected to road vibrations, or areas where extreme shock is present.

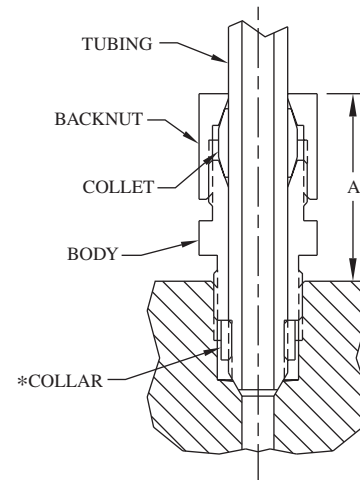

Connection	Catalog Number	Backnut Hex Size	Body Hex Size	Height 'A'	Collar*
1/4" M/P	20AVCG4	0.62" (15.7)	0.62" (15.7)	0.94" (23.9)	20C4
3/8" M/P	20AVCG6	0.75" (19.1)	0.75" (19.1)	1.18" (30.0)	20C6
9/16" M/P	20AVCG9	0.94" (23.9)	0.94" (23.9)	1.44" (36.6)	20C9
3/4" M/P	20AVCG12	1.38" (35.1)	1.38" (35.1)	1.56" (39.6)	20C12
1" M/P	20AVCG16	1.50" (38.1)	1.50" (38.1)	1.75" (44.5)	20C16

Anti-vibration glands are manufactured of 316 stainless steel and are available with an optional bonded dry-film Moly lubricant (add suffix **-MC** to catalog number)

*Collars are not included with anti-vibration assembly and must be ordered separately.



All dimensions are for reference only and are subject to change.
Dimensions in parentheses are millimeters (mm)

MEDIUM PRESSURE CHECK VALVES

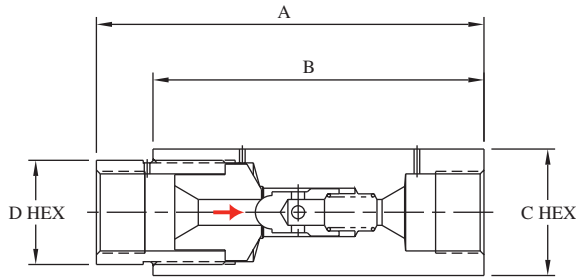

BuTech ball check valves prevent reverse flow where leak-tight shutoff is not necessary. Standard materials of construction are 316 stainless steel with 17-4PH poppet for longer life, and 300 series stainless steel spring.

Note: For 316ss wetted parts, add **-316WP** to the catalog number.

Cracking pressure: 15 PSI (1 bar) approximate

Operating Temperature Range:

-420° to +1200°F

(-251° to +648°C)

BALL CHECK VALVES

Catalog Number	Connection	MAWP	Cv	A	B	C	D
20BC4	1/4" M/P Tube	20,000 PSI 1380 bar	0.25	2.93" (74.4)	2.50" (63.5)	1.00" (25.4)	0.88" (22.4)
20BC6	3/8" M/P Tube	20,000 PSI 1380 bar	0.80	3.13" (79.5)	2.62" (66.5)	1.12" (28.4)	0.88" (22.4)
20BC9	9/16" M/P Tube	20,000 PSI 1380 bar	2.30	4.22" (107.2)	3.50" (88.9)	1.38" (35.1)	1.38" (35.1)
20BC12	3/4" M/P Tube	20,000 PSI 1380 bar	3.40	5.94" (150.9)	4.75" (120.7)	1.75" (44.5)	1.38" (35.1)
20BC16	1" M/P Tube	20,000 PSI 1380 bar	5.20	6.50" (165.1)	5.55" (141.0)	2.12" (53.8)	1.75" (44.5)

To order a valve with a cracking pressure other than the standard 15 PSI, add the cracking pressure to the end of the catalog number. Example: A 20BC9 with 50 PSI cracking pressure would be ordered as **20BC9-50**.

Cracking pressures available up to 100 PSI (7 bar)

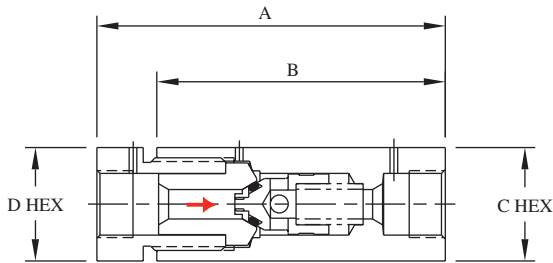

BuTech o-ring check valves reliably prevent backflow where leak-tight shutoff for liquids or gases is required. Standard materials of construction are 316 stainless steel with Buna-N o-ring and 300 series stainless steel spring.

Cracking pressure: 15 PSI (1 bar) approximate

Operating Temperature Ranges:

O-ring Material	Operating Temperature Range	Catalog Suffix
Buna-N	-65° to +250°F (-54° to +121°C)	----
Viton	-40° to +500°F (-40° to +260°C)	-VA
Teflon	-320° to +400°F (-195° to +204°C)	-TFE
Kalrez	-20° to +550°F (-29° to +288°C)	-HT

O-RING CHECK VALVES

Catalog Number	Connection	MAWP	Cv	A	B	C	D
20SC4	1/4" M/P Tube	20,000 PSI 1380 bar	0.25	2.94" (74.7)	2.50" (63.5)	1.00" (25.4)	0.88" (22.4)
20SC6	3/8" M/P Tube	20,000 PSI 1380 bar	0.80	3.12" (79.2)	2.62" (66.5)	1.12" (28.4)	0.88" (22.4)
20SC9	9/16" M/P Tube	20,000 PSI 1380 bar	2.30	4.23" (107.4)	3.50" (88.9)	1.38" (35.1)	1.38" (35.1)
20SC12	3/4" M/P Tube	20,000 PSI 1380 bar	3.40	5.89" (149.6)	4.75" (120.7)	1.75" (44.5)	1.38" (35.1)
20SC16	1" M/P Tube	20,000 PSI 1380 bar	7.40	6.50" (165.1)	5.55" (141.0)	2.12" (53.8)	1.75" (44.5)

To order a valve with a cracking pressure other than the standard 15 PSI, add the cracking pressure to the end of the catalog number. Example: A 20SC4 with 40 PSI cracking pressure would be ordered as **20SC4-40**.

Cracking pressures available up to 100 PSI (7 bar)

All dimensions are for reference only and are subject to change.
Dimensions in parentheses are millimeters (mm)

MEDIUM PRESSURE FILTERS

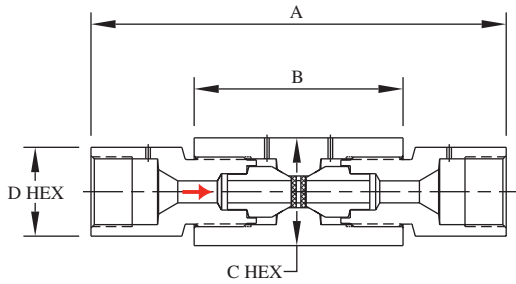

BuTech line filters are used in system lines to remove contaminating particles from the system fluid. Upstream filter of larger micron rating than downstream filter to prevent clogging of downstream filter.

Standard materials of construction are 316 stainless steel with 300 series stainless steel filter discs. Available in nominal ratings of: 0.5, 2, 5, 10, 20, 40, and 100 micron.

LINE FILTERS

Catalog Number	Connection	MAWP	Area*	A	B	C	D
20LF4	1/4" M/P Tube	20,000 PSI 1380 bar	0.15 in ² 97 mm ²	4.12" (104.6)	2.12" (53.8)	1.00" (25.4)	0.88" (22.4)
20LF6	3/8" M/P Tube	20,000 PSI 1380 bar	0.15 in ² 97 mm ²	4.12" (104.6)	2.12" (53.8)	1.00" (25.4)	0.88" (22.4)
20LF9	9/16" M/P Tube	20,000 PSI 1380 bar	0.22 in ² 142 mm ²	3.86" (98.0)	2.50" (63.5)	1.38" (35.1)	1.12" (28.4)
20LF12	3/4" M/P Tube	20,000 PSI 1380 bar	0.50 in ² 323 mm ²	6.69" (169.9)	3.50" (88.9)	1.75" (44.5)	1.38" (35.1)
20LF16	1" M/P Tube	20,000 PSI 1380 bar	0.50 in ² 323 mm ²	7.69" (195.3)	3.50" (88.9)	1.75" (44.5)	1.75" (44.5)

*Effective area of filter element

Micron rating of filter must be specified. To order, complete the catalog number with the desired micron rating, upstream first:

20LF4-40/20

specifies a line filter with 1/4" M/P connections, a 40 micron filter upstream and 20 micron downstream.

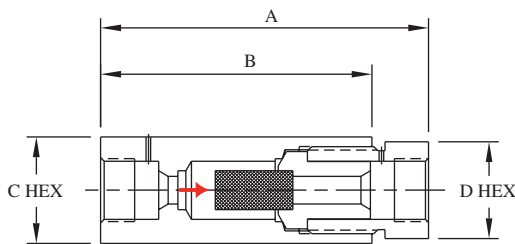

BuTech sintered cup filters offer maximum filtration surface area for removal of contaminating particles from the fluid system. They may be used in systems which require high flow rates with minimum pressure drop.

Standard materials of construction are 316 stainless steel with 300 series stainless steel filter discs. Available in nominal ratings of: 5, 10, 20, 40, and 100 micron.

SINTERED CUP FILTERS

Catalog Number	Connection	MAWP	Area*	A	B	C	D
20SCF4	1/4" M/P Tube	20,000 PSI 1380 bar	0.54 in ² 348 mm ²	3.22" (81.8)	2.50" (63.5)	1.00" (25.4)	0.88" (22.4)
20SCF6	3/8" M/P Tube	20,000 PSI 1380 bar	0.99 in ² 639 mm ²	3.12" (79.2)	2.50" (63.5)	1.38" (34.9)	1.12" (28.4)
20SC9	9/16" M/P Tube	20,000 PSI 1380 bar	1.47 in ² 948 mm ²	4.22" (107.2)	3.50" (88.9)	1.38" (35.1)	1.38" (35.1)
20SCF12	3/4" M/P Tube	20,000 PSI 1380 bar	1.75 in ² 1129 mm ²	5.90" (149.9)	4.75" (120.7)	1.75" (44.5)	1.38" (35.1)
20SCF16	1" M/P Tube	20,000 PSI 1380 bar	4.86 in ² 3135 mm ²	6.48" (164.6)	5.55" (141.0)	2.12" (53.8)	1.75" (44.5)

*Effective area of filter element

Micron rating of filter must be specified. To order, complete the catalog number with the desired micron rating:

20SCF4-20

specifies a line filter with 1/4" M/P connections and a 20 micron filter.

All dimensions are for reference only and are subject to change.
Dimensions in parentheses are millimeters (mm)

MEDIUM PRESSURE SAFETY HEADS & RUPTURE DISCS

BuTech safety head assemblies serve as holders for standard rupture discs (sold separately). Safety heads with rupture discs are used as simple and inexpensive overpressure relief devices. System pressure is relieved as a result of rupture of the replaceable disc.

The safety head assemblies shown are designed for use in high pressure systems up to 20,000 PSI (1380 bar). They can be installed directly into any of our standard couplings, elbows, tees, or crosses. Their versatility also allows direct installation into a standard 3-way valve. The result is a combination valve/safety head with beneficial cost and space advantages.

Standard material of construction is 316 stainless steel.

Safety head assemblies and rupture discs are available in two styles:

The **1/4A** style features a 1/4" blow-out diameter, an angular seat and can be ordered in pressures from 900 to 60,000 PSI (62 to 4140 bar)

The **1/2F** style features a 1/2" blow-out diameter, a flat seat and can be ordered in pressures from 500 to 10,000 PSI (34 to 689 bar). This style also has a reversible hold-down ring which greatly reduces the possibility of premature disc failure associated with installation errors inherent in some designs.

Rupture discs are available in a wide range of burst ratings. Factors such as corrosion, fatigue and temperature may affect the burst pressure of the disc and cause premature failure. This problem may sometimes be overcome by frequent replacement of the disc. All discs rated over 500 PSI (34 bar) have a manufacturing tolerance of 3% under to 6% over the specified rupture pressure rating.

Rupture Discs are not included in the safety head assembly. To order discs separately, use the following part numbering system:

<u>Style</u>	<u>Material</u>	<u>Pressure:</u>
4=1/4" Angled	AL=Aluminum	List desired pressure at 72°F
8=1/2" Flat	IN=Inconel	(21°C) in KSI.
	MO=Monel	
	NI=Nickel	
	SI=Silver	
	SS=316SS	
	TI=Titanium	

Examples:

An Inconel disc rated for 18,000 PSI in 1/4" Angled style would be ordered as **4IN18.00**

An Aluminum disc rated for 750 PSI in 1/2" Flat style would be ordered as **8AL0.750**

SAFETY HEADS - 1/4" ANGLED DISC

Catalog Number	Connection	MAWP	A	B	C	Discharge
20SH4-1/4A	1/4" M/P Tube	20,000 PSI 1380 bar	1.00" (25.4)	2.75" (69.9)	1.00" (25.4)	3/8" FNPT
20SH6-1/4A	3/8" M/P Tube	20,000 PSI 1380 bar	1.00" (25.4)	2.68" (68.1)	1.00" (25.4)	3/8" FNPT
20SH9-1/4A	9/16" M/P Tube	20,000 PSI 1380 bar	1.00" (25.4)	2.65" (67.3)	1.00" (25.4)	3/8" FNPT
20SH12-1/4A	3/4" M/P Tube	20,000 PSI 1380 bar	1.00" (25.4)	2.88" (73.2)	1.38" (35.1)	3/8" FNPT
20SH16-1/4A	1" M/P Tube	20,000 PSI 1380 bar	1.00" (25.4)	3.38" (85.9)	1.75" (44.5)	3/8" FNPT

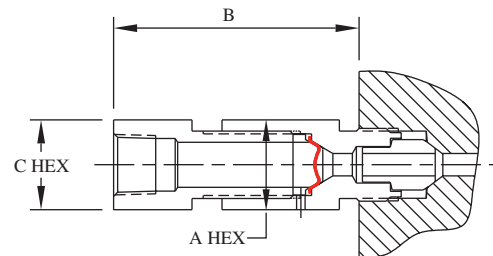

SAFETY HEADS - 1/2" FLAT DISC

Catalog Number	Connection	MAWP	A	B	C	Discharge
20SH4-1/2F	1/4" M/P Tube	10,000 PSI 689 bar	1.00" (25.4)	2.81" (71.4)	1.00" (25.4)	3/8" FNPT
20SH6-1/2F	3/8" M/P Tube	10,000 PSI 689 bar	1.00" (25.4)	2.68" (68.1)	1.00" (25.4)	3/8" FNPT
20SH9-1/2F	9/16" M/P Tube	10,000 PSI 689 bar	1.00" (25.4)	2.65" (67.3)	1.00" (25.4)	3/8" FNPT
20SH12-1/2F	3/4" M/P Tube	10,000 PSI 689 bar	1.00" (25.4)	2.88" (73.2)	1.38" (35.1)	3/8" FNPT
20SH16-1/2F	1" M/P Tube	10,000 PSI 689 bar	1.00" (25.4)	3.38" (85.9)	1.75" (44.5)	3/8" FNPT

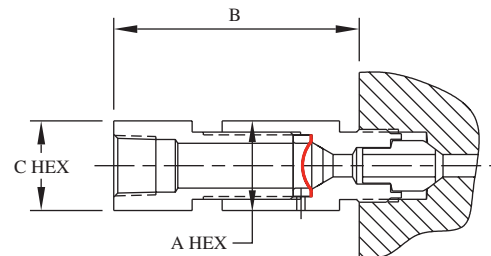

All dimensions are for reference only and are subject to change.
Dimensions in parentheses are millimeters (mm)

HIGH PRESSURE VALVES, FITTINGS AND TUBING

BuTech High Pressure Valves are designed for liquid and gas flow control in petroleum, chemical, power generating and general industrial applications.

Available in a variety of body styles, the valves are designed for operation at temperatures ranging from -100° to +600°F (-73° to +315°C). Optional packings and/or extended stuffing boxes increase the range to -423° to +1200°F (-253° to +648°C).

Their rugged construction provides assurance of fail-safe operation at pressures ranging to 150,000 PSI (10,340 bar).

Needle Valve Features:

- Non-rotating stem prevents galling and scoring
- Four stem styles:
 - Vee
 - Metering
 - Regulating
 - Micro-Metering
- 17-4PH Stem for longer service life. 316 wetted parts are also available by specifying option **-316WP** (see page HP-3)
- Glass-filled packing for temperatures to 600°F (315°C)
- Integral through holes for bracket mounting, a panel-mounting option is also available (see page HP-3)
- Wide range of options allow customizing of valve
- Positive gland locking device

Materials of Construction

Standard materials of construction include 316 cold-worked stainless steel, 17-4PH, and glass-filled teflon. All BuTech equipment may also be produced in any machinable metal. Some of the more common exotic materials used are:

- Hastelloy™
- Inconel™
- Titanium
- Monel 400™

Tube Sizes: 1/4" through 1"
Pressures to 150,000 PSI (10,340 bar)
Type: H/P Cone-and-Thread

Tube O.D.	Connection	Orifice	Cv*	MAWP+
1/4"	1/4" H/P	0.093" (2.4)	0.12	30,000 PSI 2070 bar
3/8"	3/8" H/P	0.125" (3.2)	0.23	30,000 PSI 2070 bar
9/16"	9/16" H/P	0.187" (4.7)	0.33	30,000 PSI 2070 bar
1"	1" H/P	0.438" (11.1)	2.80	30,000 PSI 2070 bar
9/16"	9/16" H/P	0.109" (2.8)	0.31	40,000 PSI 2760 bar
1/4"	1/4" H/P	0.062" (1.6)	0.08	60,000 PSI 4140 bar
3/8"	3/8" H/P	0.062" (1.6)	0.09	60,000 PSI 4140 bar
9/16"	9/16" H/P	0.078" (2.0)	0.14	60,000 PSI 4140 bar
5/16"	5/16" H/P	0.094" (2.4)	0.08	150,000 PSI 10340 bar

*Cv values listed are for 2-way straight pattern valves excluding metering valves.

For 2-way angle pattern valves, increase Cv value by 50%.

For Metering Valves: Cv=.004, Port size=0.062" (1.57 mm)

+Maximum allowable working pressure at 72° F (22° C)

Equipment	Page
150,000 PSI Equipment	HP-19
Anti-Vibration Glands	HP-15
Bulkhead Couplings	HP-13
Caps	HP-15
Check Valves	HP-16
Collars	HP-15
Couplings	HP-13
Crosses	HP-12
Elbows	HP-12
Filters	HP-17
Glands	HP-15
Metering and Needle Valves, 30,000 PSI	HP-4
Metering and Needle Valves, 60,000 PSI	HP-9
Needle Valves, 40,000 PSI	HP-8
Nipples	HP-14
Options	HP-3
Plugs	HP-15
Safety Heads	HP-18
Tees	HP-12
Tubing	HP-14

Collars and Glands included with all valves and fittings

All dimensions are for reference only and are subject to change.
 Dimensions in parentheses are millimeters (mm)



ORDERING INFORMATION & REPLACEMENT PARTS

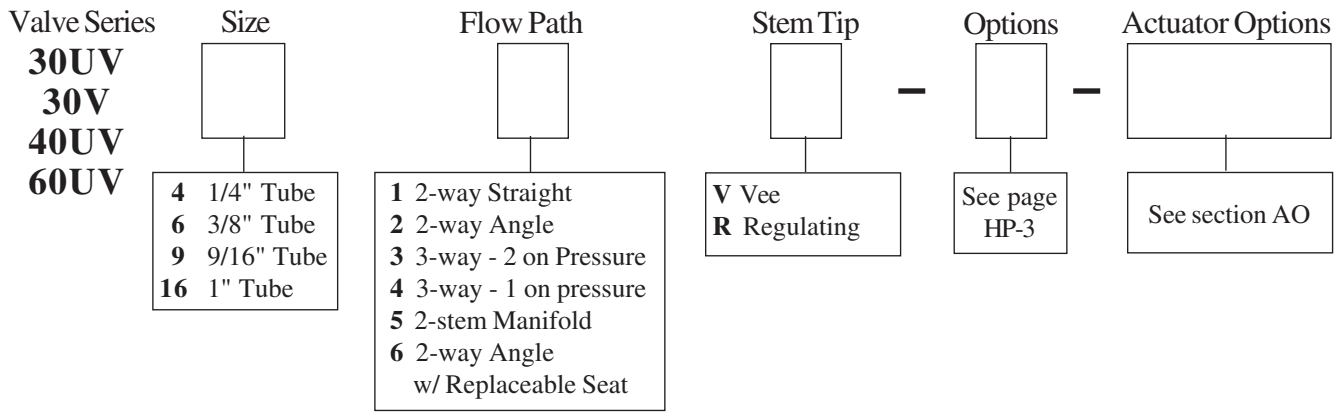

Examples:

30UV42V specifies a 2-way angle valve for 1/4" tube with a Vee stem

60UV91R-PM specifies a 2-way straight valve for 9/16" tube with regulating stem and panel-mount packing gland option

Replacement Parts

BuTech offers replacement parts in a variety of packages so you can purchase just the parts you need.

Replacement Stem Kit contains just the stem

Replacement Packing Kit contains all soft packing rings

Repair Kits contain stem, stem sleeve, stem nuts and washers, packings and packing washers (replacement seat where applicable)

Valve Series	Repair Kits		Replacement Stem	Replacement Packings	Replacement Valve Body
	All others	Replaceable Seat			
30UV4	RK-30UV4*	RK-30UV46*	30S4*	30PK4*	30UV4+
30UV6	RK-30UV6*	RK-30UV66*	30S6*	30PK6*	30UV6+
30UV9	RK-30UV9*	RK-30UV96*	30S9*	30PK9*	30UV9+
30V16	RK-30V16*	RK-30V166*	30S16*	30PK16*	30V16+
40UV9	RK-40UV*	RK-40UV96*	40S9*	40PK9*	40UV9+
60UV4	RK-60UV4*	RK-60UV46*	60S4*	60PK4*	60UV4+
60UV6	RK-60UV6*	RK-60UV66*	60S6*	60PK6*	60UV6+
60UV9	RK-60UV9*	RK-60UV96*	60S9*	60PK9*	60UV9+

*Complete catalog number by adding the following:

V or **R** for stem type

Suffix for special packing materials (see page HP-3)
(ex. **-GR** for Grafoil packings)

Suffix for special materials
(ex. **-HC** for Hastelloy)

-LT or **-HT** for cryogenic or high-temperature service

-WAO for a valve fitted with an actuator

+Complete catalog number by adding the flow path designator:

- 1** 2-way straight
- 2** 2-way angle
- 3** 3-way, 2 connections on pressure
- 4** 3-way, 1 connection on pressure
- 5** 2-stem manifold
- 6** 2-way angle with replaceable seat

NEEDLE VALVE OPTIONS

Packing and Stem Materials

- GR Grafoil packings for service to 800°F (426°C)
- TFE Virgin Teflon packing for service to 450°F (232°C)
- 316WP 316 wetted parts
- STS Stellite tipped stem
- SRS Stellite replaceable seat (Replaceable seat valves only)

Handle Options

- PH Round plastic handle in place of aluminum (available on 1/4" through 9/16" sizes)
- SS Stainless steel handle in place of aluminum (available on 1/4" through 9/16" sizes, on 1" SS is standard)
- EXT_ Handle extended above valve body, specify number of inches of extra height desired (Ex: **EXT6** is a 6" extension)

Security Options

- HLD Handle locking device (prevents unauthorized opening/closing of valve)
- SLD Stem locking device (prevents stem from turning due to vibration)

Extreme Service

- AVG Anti-vibration glands instead of standard glands for applications with excessive vibration or shock
- O2 Cleaned for oxygen service
- SOG For Sour Gas service in accordance with NACE MR-01-75 (See Section OF for details)
- HT Extended stuffing box, graphite packing, and materials for high-temperature service to 1200°F (648°C)
- HTF Finned extended stuffing box, graphite packing, and materials for high-temperature service to 1200°F (648°C)
- LT Extended stuffing box, teflon packing, and materials for cryogenic service to -423°F (-251°C)
- LTF Finned extended stuffing box, teflon packing, and materials for cryogenic service to -423°F (-251°C)

Valve Model	A
30UV	6.14" (156.0)
30V	10.76" (273.3)
40UV	5.88" (149.4)
60UV	5.88" (149.4)

-HT or -LT Options

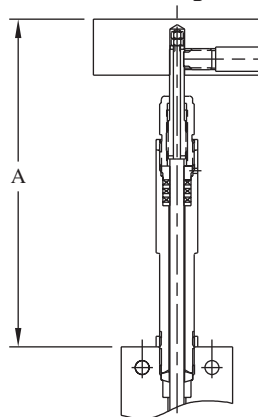

Cylindrical Bonnet

-HTF or -LTF Options

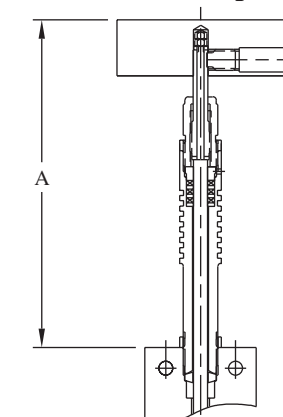

Finned Bonnet

Panel Mount

- PM Panel-mount packing gland

Valve Model	Panel Hole Size	Max Panel Thickness	H
30UV	0.84" (21.3)	0.37" (9.4)	0.48" (12.2)
30V	1.41" (35.8)	0.62" (15.7)	0.97" (24.6)
40UV	0.84" (21.3)	0.37" (9.4)	0.48" (12.2)
60UV	0.84" (21.3)	0.37" (9.4)	0.48" (12.2)

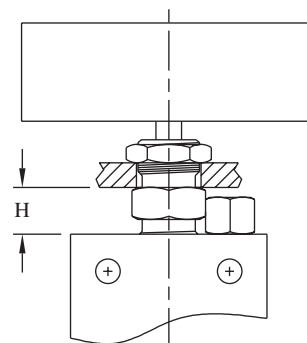

All dimensions are for reference only and are subject to change.
Dimensions in parentheses are millimeters (mm)

NEEDLE VALVES FOR 30,000 PSI (2070 BAR)

1/4" H/P TUBE, CONED AND THREADED

2-way Straight

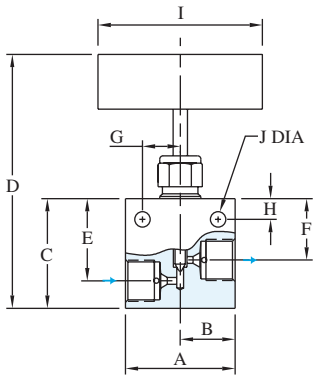

Figure 1

2-way Angle

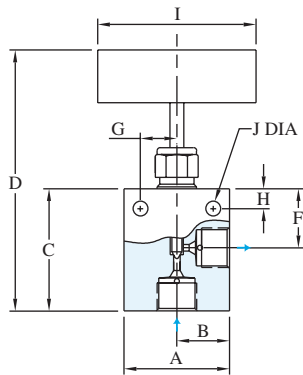

Figure 2

3-way Two on Pressure

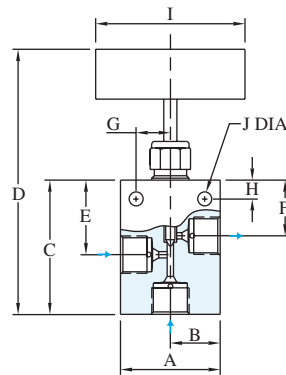

Figure 3

3-way One on Pressure

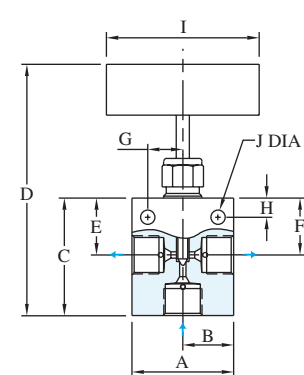

Figure 4

Catalog Number	Stem Style	Connection	A	B	C	D	E	F	G	H	I	J	K	L	Thk.	Fig
30UV41V	Vee	1/4" H/P	2.00"	1.00"	2.00"	4.75"	1.50"	1.12"	0.69"	0.38"	3.00"	0.28"	---	---	1.00"	1
30UV41R	Reg	Tube	(50.8)	(25.4)	(50.8)	(120.7)	(38.1)	(28.4)	(17.5)	(9.7)	(76.2)	(7.1)	---	---	(25.4)	
30UV42V	Vee	1/4" H/P	2.00"	1.00"	2.00"	4.75"	---	1.12"	0.69"	0.38"	3.00"	0.28"	---	---	1.00"	2
30UV42R	Reg	Tube	(50.8)	(25.4)	(50.8)	(120.7)	---	(28.4)	(17.5)	(9.7)	(76.2)	(7.1)	---	---	(25.4)	
30UV43V	Vee	1/4" H/P	2.00"	1.00"	2.12"	4.87"	1.50"	1.12"	0.69"	0.38"	3.00"	0.28"	---	---	1.00"	3
30UV43R	Reg	Tube	(50.8)	(25.4)	(53.8)	(123.7)	(38.1)	(28.4)	(17.5)	(9.7)	(76.2)	(7.1)	---	---	(25.4)	
30UV44V	Vee	1/4" H/P	2.00"	1.00"	2.00"	4.75"	1.12"	1.12"	0.69"	0.38"	3.00"	0.28"	---	---	1.00"	4
30UV44R	Reg	Tube	(50.8)	(25.4)	(50.8)	(120.7)	(28.4)	(28.4)	(17.5)	(9.7)	(76.2)	(7.1)	---	---	(25.4)	
30UV45V	Vee	1/4" H/P	2.00"	1.00"	3.06"	8.56"	1.53"	1.12"	0.69"	0.38"	3.00"	0.28"	---	---	1.00"	5
30UV45R	Reg	Tube	(50.8)	(25.4)	(77.7)	(217.4)	(38.9)	(28.4)	(17.5)	(9.7)	(76.2)	(7.1)	---	---	(25.4)	
30UV46V	Vee	1/4" H/P	2.00"	1.00"	2.38"	5.13"	---	1.12"	0.69"	0.38"	3.00"	0.28"	0.75"	1.47"	1.00"	6
30UV46R	Reg	Tube	(50.8)	(25.4)	(60.5)	(130.3)	---	(28.4)	(17.5)	(9.7)	(76.2)	(7.1)	(19.1)	(37.3)	(25.4)	
30MV46V	Meter	1/4" H/P	2.00"	1.00"	2.38"	5.42"	---	1.12"	0.69"	0.38"	3.00"	0.28"	0.75"	1.47"	1.00"	7
30MV46R	Reg	Tube	(50.8)	(25.4)	(60.5)	(137.7)	---	(28.4)	(17.5)	(9.7)	(76.2)	(7.1)	(19.1)	(37.3)	(25.4)	
30MMV46V	Micro-Meter	1/4" H/P	2.00"	1.00"	2.38"	6.10"	---	1.12"	0.69"	0.38"	3.00"	0.28"	0.75"	1.47"	1.00"	8
30MMV46R	Reg	Tube	(50.8)	(25.4)	(60.5)	(154.9)	---	(28.4)	(17.5)	(9.7)	(76.2)	(7.1)	(19.1)	(37.3)	(25.4)	

See page HP-1 for orifice and Cv

2-stem Manifold

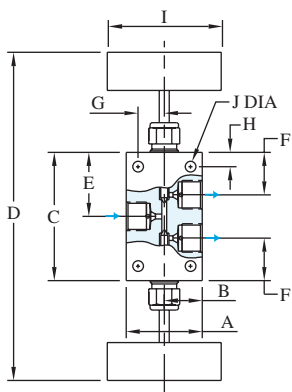

Figure 5

Replaceable Seat

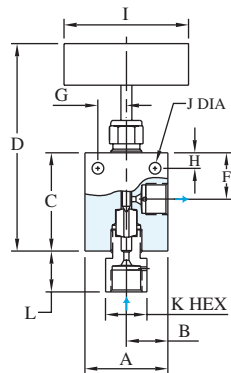

Figure 6

Metering

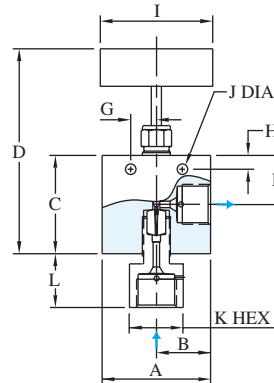

Figure 7

Micro-Metering

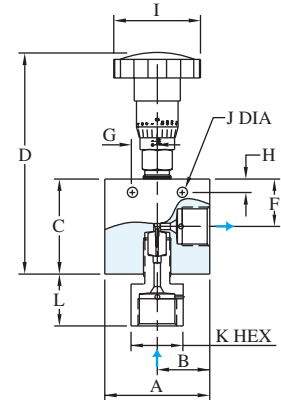

Figure 8

All dimensions are for reference only and are subject to change.
Dimensions in parentheses are millimeters (mm)

NEEDLE VALVES FOR 30,000 PSI (2070 BAR)

3/8" H/P TUBE, CONED AND THREADED

2-way Straight

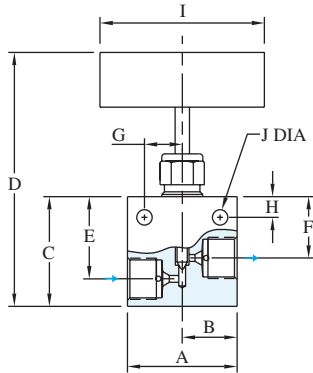

Figure 1

2-way Angle

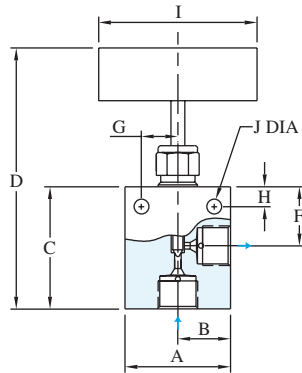

Figure 2

3-way Two on Pressure

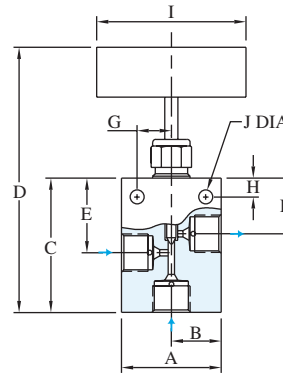

Figure 3

3-way One on Pressure

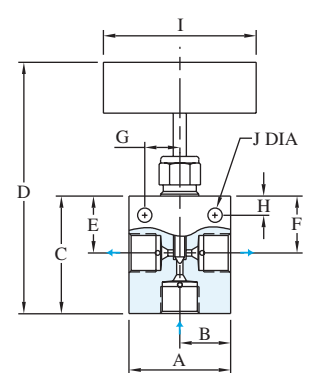

Figure 4

Catalog Number	Stem Style	Connection	A	B	C	D	E	F	G	H	I	J	K	L	Thk.	Fig
30UV61V	Vee	3/8" H/P	2.00"	1.00"	2.00"	4.75"	1.50"	1.12"	0.69"	0.38"	3.00"	0.28"	---	---	1.00"	1
30UV61R	Reg	Tube	(50.8)	(25.4)	(50.8)	(120.7)	(38.1)	(28.4)	(17.5)	(9.7)	(76.2)	(7.1)	---	---	(25.4)	
30UV62V	Vee	3/8" H/P	2.00"	1.00"	2.12"	4.87"	---	1.12"	0.69"	0.38"	3.00"	0.28"	---	---	1.00"	2
30UV62R	Reg	Tube	(50.8)	(25.4)	(53.8)	(123.7)	---	(28.4)	(17.5)	(9.7)	(76.2)	(7.1)	---	---	(25.4)	
30UV63V	Vee	3/8" H/P	2.00"	1.00"	2.50"	5.25"	1.50"	1.12"	0.69"	0.38"	3.00"	0.28"	---	---	1.00"	3
30UV63R	Reg	Tube	(50.8)	(25.4)	(63.5)	(133.4)	(38.1)	(28.4)	(17.5)	(9.7)	(76.2)	(7.1)	---	---	(25.4)	
30UV64V	Vee	3/8" H/P	2.00"	1.00"	2.12"	4.87"	1.12"	1.12"	0.69"	0.38"	3.00"	0.28"	---	---	1.00"	4
30UV64R	Reg	Tube	(50.8)	(25.4)	(53.8)	(123.7)	(28.4)	(28.4)	(17.5)	(9.7)	(76.2)	(7.1)	---	---	(25.4)	
30UV65V	Vee	3/8" H/P	2.00"	1.00"	3.25"	8.75"	1.62"	1.12"	0.69"	0.38"	3.00"	0.28"	---	---	1.00"	5
30UV65R	Reg	Tube	(50.8)	(25.4)	(82.6)	(222.3)	(41.1)	(28.4)	(17.5)	(9.7)	(76.2)	(7.1)	---	---	(25.4)	
30UV66V	Vee	3/8" H/P	2.00"	1.00"	2.38"	5.13"	---	1.12"	0.69"	0.38"	3.00"	0.28"	1.00"	1.15"	1.00"	6
30UV66R	Reg	Tube	(50.8)	(25.4)	(60.5)	(130.3)	---	(28.4)	(17.5)	(9.7)	(76.2)	(7.1)	(25.4)	(29.2)	(25.4)	
30MV66V	Meter	3/8" H/P	2.00"	1.00"	2.38"	5.42"	---	1.12"	0.69"	0.38"	3.00"	0.28"	1.00"	1.15"	1.00"	7
30MV66R	Reg	Tube	(50.8)	(25.4)	(60.5)	(137.7)	---	(28.4)	(17.5)	(9.7)	(76.2)	(7.1)	(25.4)	(29.2)	(25.4)	
30MMV66V	Micro-Meter	3/8" H/P	2.00"	1.00"	2.38"	6.10"	---	1.12"	0.69"	0.38"	3.00"	0.28"	1.00"	1.15"	1.00"	8
30MMV66R	Reg	Tube	(50.8)	(25.4)	(60.5)	(154.9)	---	(28.4)	(17.5)	(9.7)	(76.2)	(7.1)	(25.4)	(29.2)	(25.4)	

See page HP-1 for orifice and Cv

2-stem Manifold

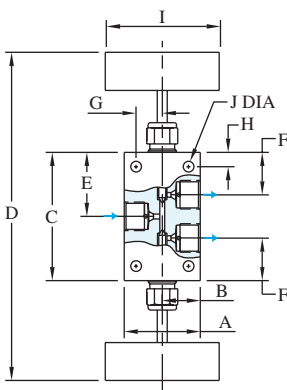

Figure 5

Replaceable Seat

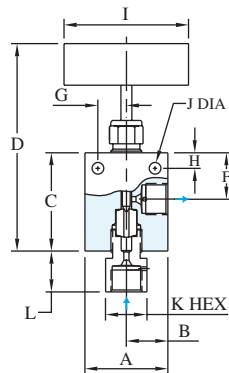

Figure 6

Metering

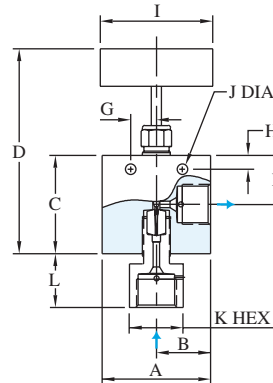

Figure 7

Micro-Metering

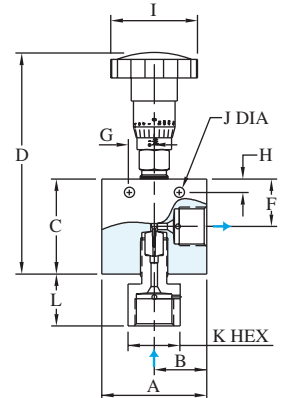

Figure 8

All dimensions are for reference only and are subject to change.
Dimensions in parentheses are millimeters (mm)



NEEDLE VALVES FOR 30,000 PSI (2070 BAR)

9/16" H/P TUBE, CONED AND THREADED

2-way Straight

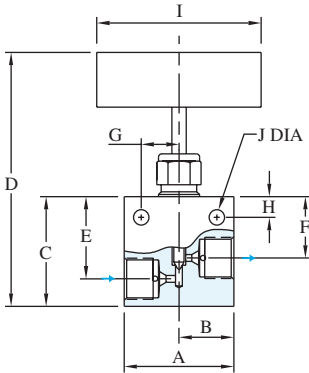

Figure 1

2-way Angle

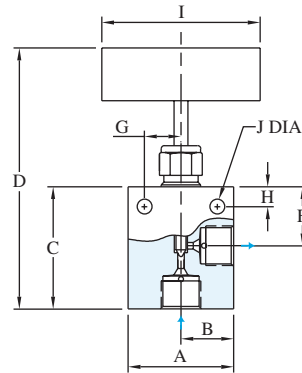

Figure 2

3-way Two on Pressure

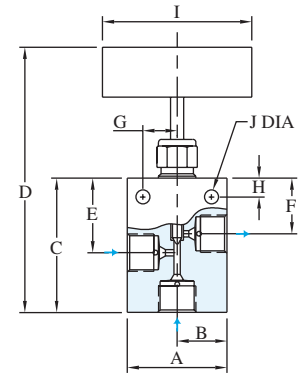

Figure 3

Catalog Number	Stem Style	Connection	A	B	C	D	E	F	G	H	I	J	K	L	Thk.	Fig
30UV91V	Vee	9/16" H/P	2.62"	1.31"	2.44"	5.19"	1.56"	1.12"	0.69"	0.38"	3.00"	0.28"	---	---	1.50"	1
30UV91R	Reg	Tube	(66.5)	(33.3)	(62.0)	(131.8)	(39.6)	(28.4)	(17.5)	(9.7)	(76.2)	(7.1)	---	---	(38.1)	
30UV92V	Vee	9/16" H/P	2.62"	1.31"	2.44"	5.75"	---	1.12"	0.69"	0.38"	3.00"	0.28"	---	---	1.50"	2
30UV92R	Reg	Tube	(66.5)	(33.3)	(62.0)	(146.1)	---	(28.4)	(17.5)	(9.7)	(76.2)	(7.1)	---	---	(38.1)	
30UV93V	Vee	9/16" H/P	2.62"	1.31"	2.88"	5.63"	1.56"	1.12"	0.69"	0.38"	3.00"	0.28"	---	---	1.50"	3
30UV93R	Reg	Tube	(66.5)	(33.3)	(73.2)	(143.0)	(39.6)	(28.4)	(17.5)	(9.7)	(76.2)	(7.1)	---	---	(38.1)	
30UV94V	Vee	9/16" H/P	2.62"	1.31"	2.44"	5.19"	1.12"	1.12"	0.69"	0.38"	3.00"	0.28"	---	---	1.50"	4
30UV94R	Reg	Tube	(66.5)	(33.3)	(62.0)	(131.8)	(28.4)	(28.4)	(17.5)	(9.7)	(76.2)	(7.1)	---	---	(38.1)	
30UV95V	Vee	9/16" H/P	2.62"	1.31"	4.75"	10.25"	2.38"	1.62"	0.69"	0.50"	3.00"	0.28"	---	---	1.50"	5
30UV95R	Reg	Tube	(66.5)	(33.3)	(120.7)	(260.4)	(60.5)	(41.1)	(17.5)	(12.7)	(76.2)	(7.1)	---	---	(38.1)	
30UV96V	Vee	9/16" H/P	2.62"	1.31"	2.44"	5.19"	---	1.19"	0.69"	0.38"	3.00"	0.28"	1.38"	1.65"	1.50"	6
30UV96R	Reg	Tube	(66.5)	(33.3)	(62.0)	(131.8)	---	(30.2)	(17.5)	(9.7)	(76.2)	(7.1)	(35.1)	(41.9)	(38.1)	

See page HP-1 for orifice and Cv

3-way One on Pressure

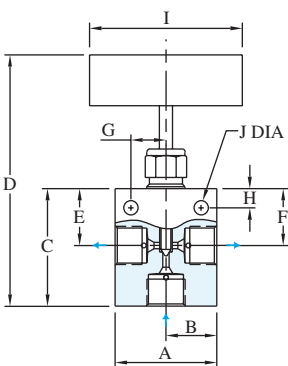

Figure 4

2-stem Manifold

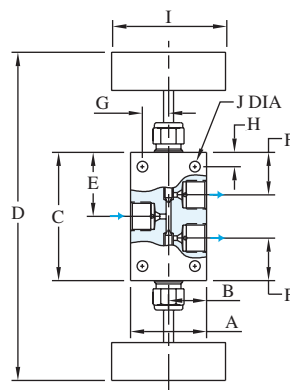

Figure 5

Replaceable Seat

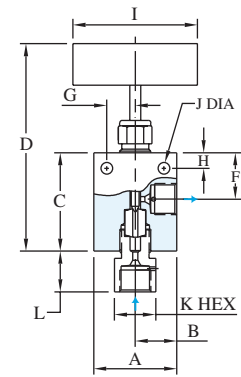

Figure 6

NEEDLE VALVES FOR 30,000 PSI (2070 BAR)

1" H/P TUBE, CONED AND THREADED

2-way Straight

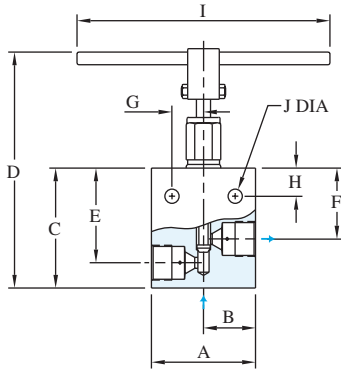

Figure 1

2-way Angle

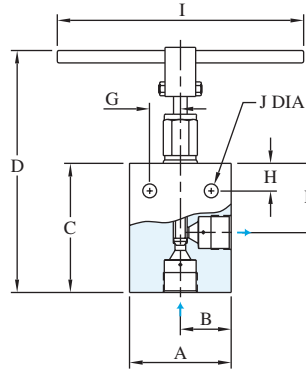

Figure 2

3-way Two on Pressure

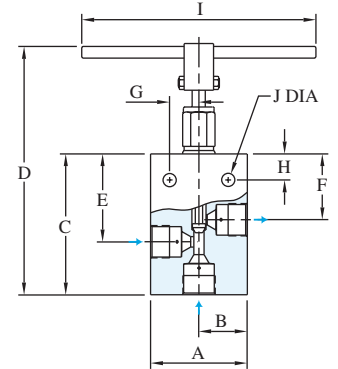

Figure 3

Catalog Number	Stem Style	Connection	A	B	C	D	E	F	G	H	I	J	K	L	Thk.	Fig
30V161V	Vee	1" H/P	4.12"	2.06"	4.75"	10.04"	3.75"	2.81"	1.25"	1.12"	10.00"	0.56"	---	---	1.75"	1
30V161R	Reg	Tube	(104.6)	(52.3)	(120.7)	(255.0)	(95.3)	(71.4)	(31.8)	(28.4)	(254.0)	(14.2)	---	---	(44.5)	
30V162V	Vee	1" H/P	4.12"	2.06"	5.25"	10.54"	---	2.81"	1.25"	1.12"	10.00"	0.56"	---	---	1.75"	2
30V162R	Reg	Tube	(104.6)	(52.3)	(133.4)	(267.7)	---	(71.4)	(31.8)	(28.4)	(254.0)	(14.2)	---	---	(44.5)	
30V163V	Vee	1" H/P	4.12"	2.06"	6.00"	11.25"	3.75"	2.81"	1.25"	1.12"	10.00"	0.56"	---	---	1.75"	3
30V163R	Reg	Tube	(104.6)	(52.3)	(152.4)	(285.8)	(95.3)	(71.4)	(31.8)	(28.4)	(254.0)	(14.2)	---	---	(44.5)	
30V164V	Vee	1" H/P	4.12"	2.06"	5.25"	10.54"	2.81"	2.81"	1.25"	1.12"	10.00"	0.56"	---	---	1.75"	4
30V164R	Reg	Tube	(104.6)	(52.3)	(133.4)	(267.7)	(71.4)	(71.4)	(31.8)	(28.4)	(254.0)	(14.2)	---	---	(44.5)	
30V165V	Vee	1" H/P	4.12"	2.06"	8.00"	18.58"	4.00"	2.81"	1.25"	1.12"	10.00"	0.56"	---	---	1.75"	5
30V165R	Reg	Tube	(104.6)	(52.3)	(203.2)	(471.9)	(101.6)	(71.4)	(31.8)	(28.4)	(254.0)	(14.2)	---	---	(44.5)	
30V166V	Vee	1" H/P	4.12"	2.06"	4.87"	10.16"	---	2.81"	1.25"	1.12"	10.00"	0.56"	1.75"	2.06"	1.75"	6
30V166R	Reg	Tube	(104.6)	(52.3)	(123.7)	(258.1)	---	(71.4)	(31.8)	(28.4)	(254.0)	(14.2)	(44.5)	(52.3)	(44.5)	

See page HP-1 for orifice and Cv

3-way One on Pressure

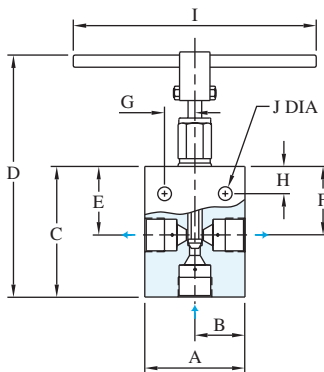

Figure 4

2-stem Manifold

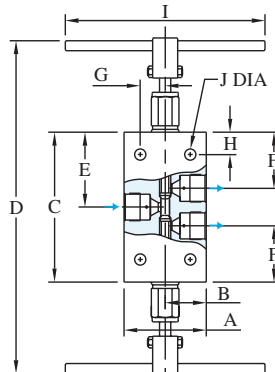

Figure 5

Replaceable Seat

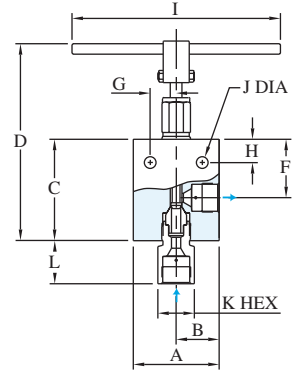

Figure 6



All dimensions are for reference only and are subject to change.
Dimensions in parentheses are millimeters (mm)



NEEDLE VALVES FOR 40,000 PSI (2760 BAR)

9/16" H/P TUBE, CONED AND THREADED

2-way Straight

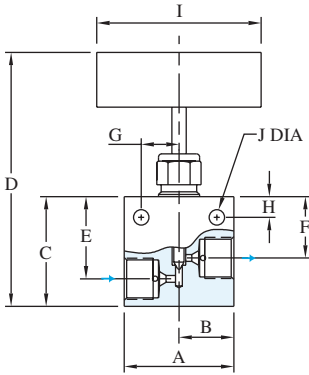

Figure 1

2-way Angle

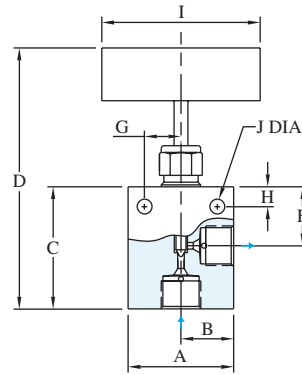

Figure 2

3-way Two on Pressure

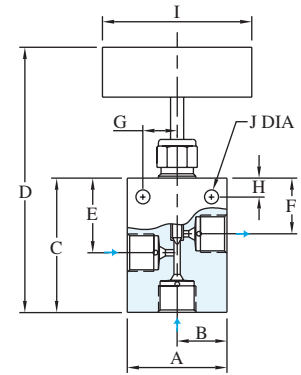

Figure 3

Catalog Number	Stem Style	Connection	A	B	C	D	E	F	G	H	I	J	K	L	Thk.	Fig
40UV91V	Vee	9/16" H/P	2.62"	1.31"	2.50"	5.25"	1.69"	1.31"	0.69"	0.38"	3.00"	0.28"	---	---	1.50"	1
40UV91R	Reg	Tube	(66.5)	(33.3)	(63.5)	(133.4)	(42.9)	(33.3)	(17.5)	(9.7)	(76.2)	(7.1)	---	---	(38.1)	
40UV92V	Vee	9/16" H/P	2.62"	1.31"	2.81"	5.56"	---	1.31"	0.69"	0.38"	3.00"	0.28"	---	---	1.50"	2
40UV92R	Reg	Tube	(66.5)	(33.3)	(71.4)	(141.2)	---	(33.3)	(17.5)	(9.7)	(76.2)	(7.1)	---	---	(38.1)	
40UV93V	Vee	9/16" H/P	2.62"	1.31"	3.03"	5.78"	1.75"	1.31"	0.69"	0.38"	3.00"	0.28"	---	---	1.50"	3
40UV93R	Reg	Tube	(66.5)	(33.3)	(77.0)	(146.8)	(44.5)	(33.3)	(17.5)	(9.7)	(76.2)	(7.1)	---	---	(38.1)	
40UV94V	Vee	9/16" H/P	2.62"	1.31"	2.81"	5.56"	1.31"	1.31"	0.69"	0.38"	3.00"	0.28"	---	---	1.50"	4
40UV94R	Reg	Tube	(66.5)	(33.3)	(71.4)	(141.2)	(33.3)	(33.3)	(17.5)	(9.7)	(76.2)	(7.1)	---	---	(38.1)	
40UV95V	Vee	9/16" H/P	2.62"	1.31"	4.12"	9.62"	2.06"	1.31"	0.69"	0.50"	3.00"	0.28"	---	---	1.50"	5
40UV95R	Reg	Tube	(66.5)	(33.3)	(104.6)	(244.3)	(52.3)	(33.3)	(17.5)	(12.7)	(76.2)	(7.1)	---	---	(38.1)	
40UV96V	Vee	9/16" H/P	2.62"	1.31"	2.62"	5.37"	---	1.31"	0.69"	0.38"	3.00"	0.28"	1.37"	1.39"	1.50"	6
40UV96R	Reg	Tube	(66.5)	(33.3)	(66.5)	(136.4)	---	(33.3)	(17.5)	(9.7)	(76.2)	(7.1)	(34.8)	(35.3)	(38.1)	

See page HP-1 for orifice and Cv

3-way One on Pressure

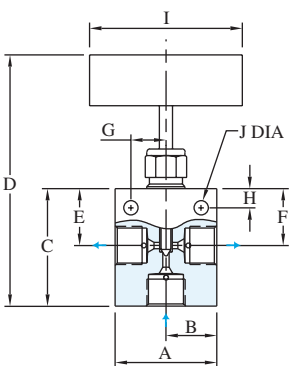

Figure 4

2-stem Manifold

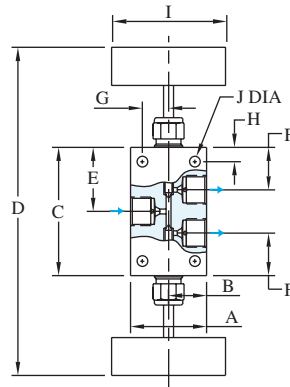

Figure 5

Replaceable Seat

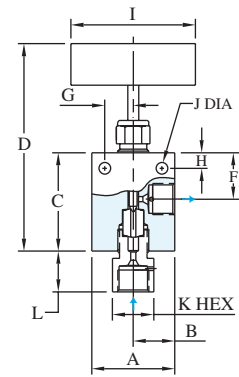

Figure 6

NEEDLE VALVES FOR 60,000 PSI (4140 BAR)

1/4" H/P TUBE, CONED AND THREADED

2-way Straight

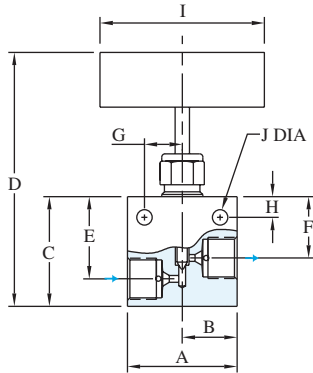

Figure 1

2-way Angle

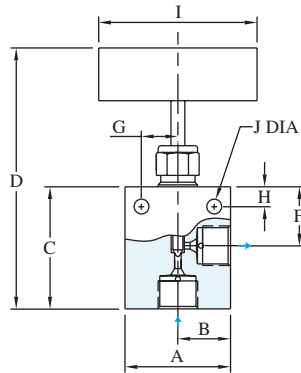

Figure 2

3-way Two on Pressure

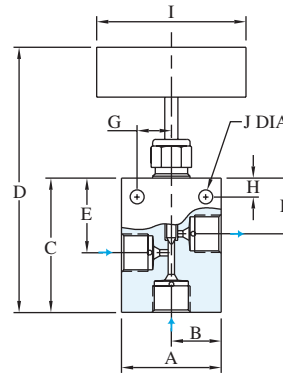

Figure 3

3-way One on Pressure

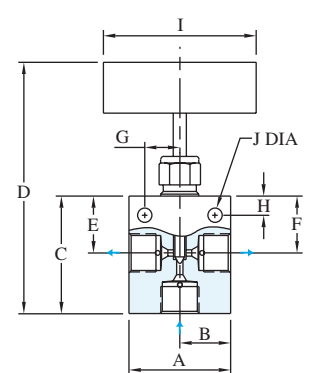

Figure 4

Catalog Number	Stem Style	Connection	A	B	C	D	E	F	G	H	I	J	K	L	Thk.	Fig
60UV41V 60UV41R	Vee Reg	1/4" H/P Tube	2.00" (50.8)	1.00" (25.4)	2.12" (53.8)	4.87" (123.7)	1.69" (42.9)	1.31" (33.3)	0.69" (17.5)	0.38" (9.7)	3.00" (76.2)	0.25" (6.4)	---	---	1.00" (25.4)	1
60UV42V 60UV42R	Vee Reg	1/4" H/P Tube	2.00" (50.8)	1.00" (25.4)	2.38" (60.5)	5.13" (130.3)	---	1.31" (33.3)	0.69" (17.5)	0.38" (9.7)	3.00" (76.2)	0.25" (6.4)	---	---	1.00" (25.4)	2
60UV43V 60UV43R	Vee Reg	1/4" H/P Tube	2.00" (50.8)	1.00" (25.4)	2.38" (60.5)	5.13" (130.3)	1.69" (42.9)	1.31" (33.3)	0.69" (17.5)	0.38" (9.7)	3.00" (76.2)	0.25" (6.4)	---	---	1.00" (25.4)	3
60UV44V 60UV44R	Vee Reg	1/4" H/P Tube	2.00" (50.8)	1.00" (25.4)	2.38" (60.5)	5.13" (130.3)	1.31" (33.3)	1.31" (33.3)	0.69" (17.5)	0.38" (9.7)	3.00" (76.2)	0.25" (6.4)	---	---	1.00" (25.4)	4
60UV45V 60UV45R	Vee Reg	1/4" H/P Tube	2.00" (50.8)	1.00" (25.4)	3.44" (87.4)	8.94" (227.1)	1.72" (43.7)	1.31" (33.3)	0.69" (17.5)	0.38" (9.7)	3.00" (76.2)	0.25" (6.4)	---	---	1.00" (25.4)	5
60UV46V 60UV46R	Vee Reg	1/4" H/P Tube	2.00" (50.8)	1.00" (25.4)	2.62" (66.5)	5.37" (136.4)	---	1.31" (33.3)	0.69" (17.5)	0.38" (9.7)	3.00" (76.2)	0.25" (6.4)	0.75" (19.1)	1.29" (32.8)	1.00" (25.4)	6
60MV46V	Meter	1/4" H/P Tube	2.00" (50.8)	1.00" (25.4)	2.62" (66.5)	6.95" (176.5)	---	1.31" (33.3)	0.69" (17.5)	0.38" (9.7)	3.00" (76.2)	0.25" (6.4)	0.75" (19.1)	1.29" (32.8)	1.00" (25.4)	7
60MMV46V	Micro-Meter	1/4" H/P Tube	2.00" (50.8)	1.00" (25.4)	2.62" (66.5)	7.63" (193.8)	---	1.31" (33.3)	0.69" (17.5)	0.38" (9.7)	3.00" (76.2)	0.25" (6.4)	0.75" (19.1)	1.29" (32.8)	1.00" (25.4)	8

See page HP-1 for orifice and Cv

2-stem Manifold

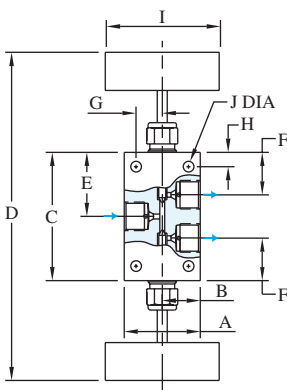

Figure 5

Replaceable Seat

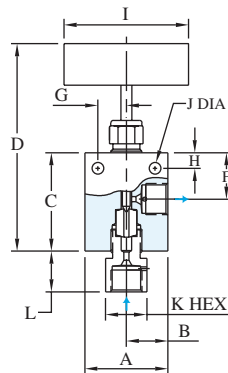

Figure 6

Metering

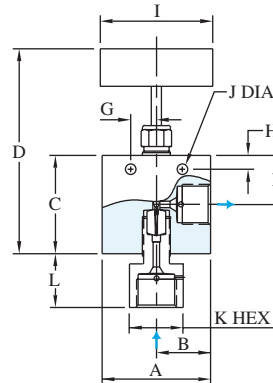

Figure 7

Micro-Metering

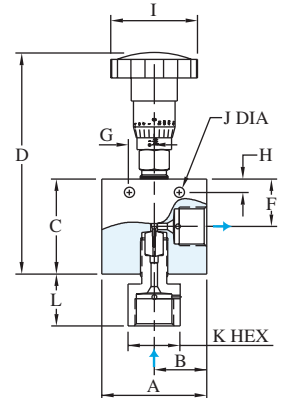

Figure 8

All dimensions are for reference only and are subject to change.
Dimensions in parentheses are millimeters (mm)

NEEDLE VALVES FOR 60,000 PSI (4140 BAR)

3/8" H/P TUBE, CONED AND THREADED

2-way Straight

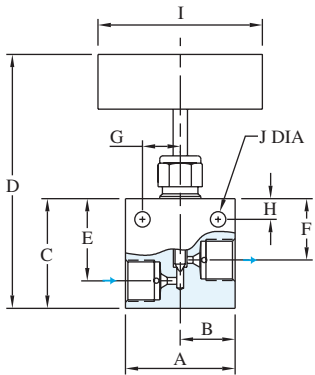

Figure 1

2-way Angle

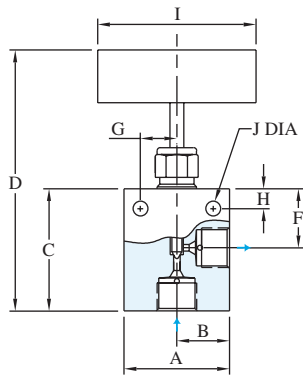

Figure 2

3-way Two on Pressure

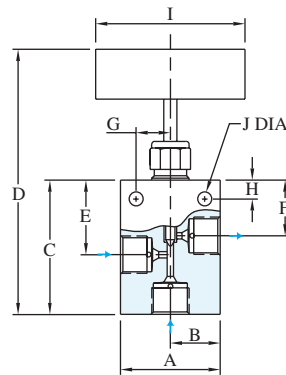

Figure 3

3-way One on Pressure

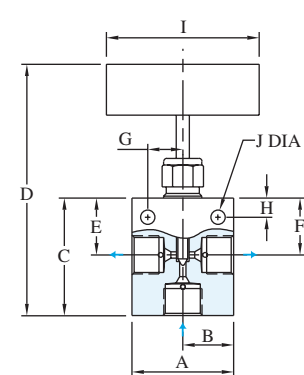

Figure 4

Catalog Number	Stem Style	Connection	A	B	C	D	E	F	G	H	I	J	K	L	Thk.	Fig
60UV61V	Vee	3/8" H/P	2.00"	1.00"	2.25"	5.00"	1.69"	1.31"	0.69"	0.38"	3.00"	0.25"	---	---	1.00"	1
60UV61R	Reg	Tube	(50.8)	(25.4)	(57.2)	(127.0)	(42.9)	(33.3)	(17.5)	(9.7)	(76.2)	(6.4)	---	---	(25.4)	
60UV62V	Vee	3/8" H/P	2.00"	1.00"	2.62"	5.37"	---	1.31"	0.69"	0.38"	3.00"	0.25"	---	---	1.00"	2
60UV62R	Reg	Tube	(50.8)	(25.4)	(66.5)	(136.4)	---	(33.3)	(17.5)	(9.7)	(76.2)	(6.4)	---	---	(25.4)	
60UV63V	Vee	3/8" H/P	2.00"	1.00"	2.75"	5.50"	1.69"	1.31"	0.69"	0.38"	3.00"	0.25"	---	---	1.00"	3
60UV63R	Reg	Tube	(50.8)	(25.4)	(69.9)	(139.7)	(42.9)	(33.3)	(17.5)	(9.7)	(76.2)	(6.4)	---	---	(25.4)	
60UV64V	Vee	3/8" H/P	2.00"	1.00"	2.62"	5.37"	1.31"	1.31"	0.69"	0.38"	3.00"	0.25"	---	---	1.00"	4
60UV64R	Reg	Tube	(50.8)	(25.4)	(66.5)	(136.4)	(33.3)	(33.3)	(17.5)	(9.7)	(76.2)	(6.4)	---	---	(25.4)	
60UV65V	Vee	3/8" H/P	2.00"	1.00"	3.75"	9.25"	1.88"	1.31"	0.69"	0.38"	3.00"	0.25"	---	---	1.00"	5
60UV65R	Reg	Tube	(50.8)	(25.4)	(95.3)	(235.0)	(47.8)	(33.3)	(17.5)	(9.7)	(76.2)	(6.4)	---	---	(25.4)	
60UV66V	Vee	3/8" H/P	2.00"	1.00"	2.62"	5.37"	---	1.31"	0.69"	0.38"	3.00"	0.25"	1.00"	1.21"	1.00"	6
60UV66R	Reg	Tube	(50.8)	(25.4)	(66.5)	(136.4)	---	(33.3)	(17.5)	(9.7)	(76.2)	(6.4)	(25.4)	(30.7)	(25.4)	
60MV66V	Meter	3/8" H/P	2.50"	1.25"	2.62"	6.95"	---	1.31"	0.69"	0.38"	3.00"	0.25"	1.00"	1.21"	1.00"	7
		Tube	(63.5)	(31.8)	(66.5)	(176.5)	---	(33.3)	(17.5)	(9.7)	(76.2)	(6.4)	(25.4)	(30.7)	(25.4)	
60MMV66V	Micro-Meter	3/8" H/P	2.00"	1.00"	2.62"	7.63"	---	1.31"	0.69"	0.38"	3.00"	0.25"	1.00"	1.21"	1.00"	8
		Tube	(50.8)	(25.4)	(66.5)	(193.8)	---	(33.3)	(17.5)	(9.7)	(76.2)	(6.4)	(25.4)	(30.7)	(25.4)	

See page HP-1 for orifice and Cv

2-stem Manifold

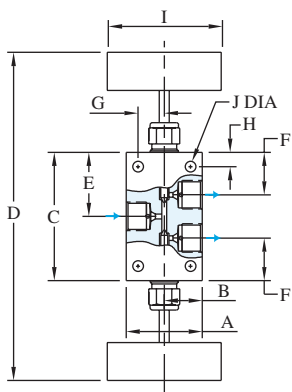

Figure 5

Replaceable Seat

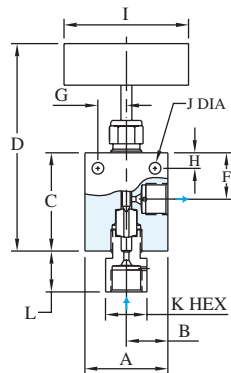

Figure 6

Metering

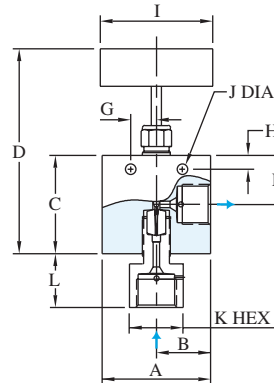

Figure 7

Micro-Metering

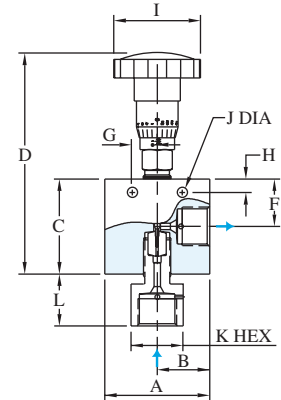

Figure 8

All dimensions are for reference only and are subject to change.
Dimensions in parentheses are millimeters (mm)

NEEDLE VALVES FOR 60,000 PSI (4140 BAR)

9/16" H/P TUBE, CONED AND THREADED

2-way Straight

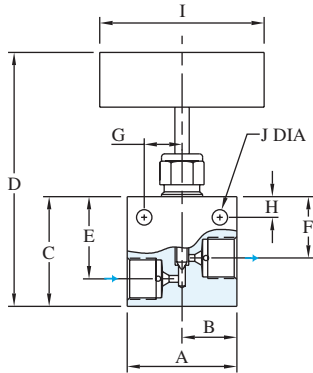

Figure 1

2-way Angle

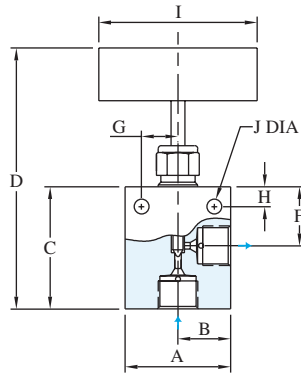

Figure 2

3-way Two on Pressure

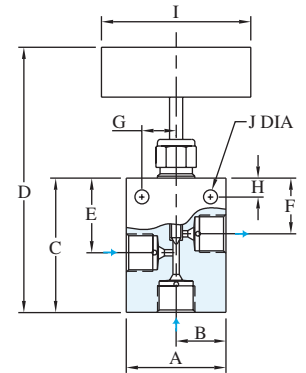

Figure 3

Catalog Number	Stem Style	Connection	A	B	C	D	E	F	G	H	I	J	K	L	Thk.	Fig
60UV91V	Vee	9/16" H/P	2.62"	1.31"	2.50"	5.25"	1.69"	1.31"	0.69"	0.38"	3.00"	0.28"	---	---	1.50"	1
60UV91R	Reg	Tube	(66.5)	(33.3)	(63.5)	(133.4)	(42.9)	(33.3)	(17.5)	(9.7)	(76.2)	(7.1)	---	---	(38.1)	
60UV92V	Vee	9/16" H/P	2.62"	1.31"	2.81"	5.56"	---	1.31"	0.69"	0.38"	3.00"	0.28"	---	---	1.50"	2
60UV92R	Reg	Tube	(66.5)	(33.3)	(71.4)	(141.2)	---	(33.3)	(17.5)	(9.7)	(76.2)	(7.1)	---	---	(38.1)	
60UV93V	Vee	9/16" H/P	2.62"	1.31"	3.03"	5.78"	1.75"	1.31"	0.69"	0.38"	3.00"	0.28"	---	---	1.50"	3
60UV93R	Reg	Tube	(66.5)	(33.3)	(77.0)	(146.8)	(44.5)	(33.3)	(17.5)	(9.7)	(76.2)	(7.1)	---	---	(38.1)	
60UV94V	Vee	9/16" H/P	2.62"	1.31"	2.81"	5.56"	1.31"	1.31"	0.69"	0.38"	3.00"	0.28"	---	---	1.50"	4
60UV94R	Reg	Tube	(66.5)	(33.3)	(71.4)	(141.2)	(33.3)	(33.3)	(17.5)	(9.7)	(76.2)	(7.1)	---	---	(38.1)	
60UV95V	Vee	9/16" H/P	2.62"	1.31"	4.12"	9.62"	2.06"	1.31"	0.69"	0.50"	3.00"	0.28"	---	---	1.50"	5
60UV95R	Reg	Tube	(66.5)	(33.3)	(104.6)	(244.3)	(52.3)	(33.3)	(17.5)	(12.7)	(76.2)	(7.1)	---	---	(38.1)	
60UV96V	Vee	9/16" H/P	2.62"	1.31"	2.62"	5.37"	---	1.31"	0.69"	0.38"	3.00"	0.28"	1.37"	1.39"	1.50"	6
60UV96R	Reg	Tube	(66.5)	(33.3)	(66.5)	(136.4)	---	(33.3)	(17.5)	(9.7)	(76.2)	(7.1)	(34.8)	(35.3)	(38.1)	

See page HP-1 for orifice and Cv

3-way One on Pressure

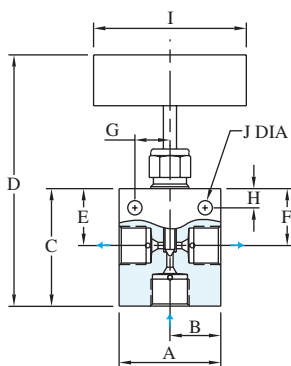

Figure 4

2-stem Manifold

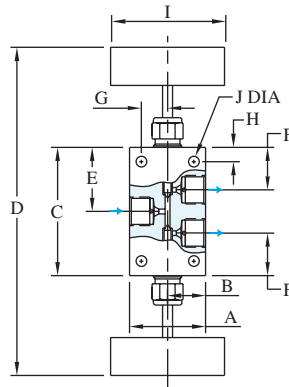

Figure 5

Replaceable Seat

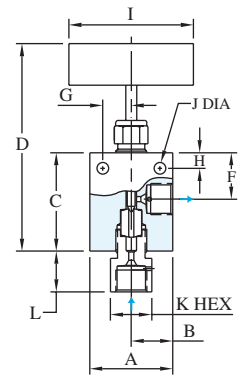

Figure 6



All dimensions are for reference only and are subject to change.
Dimensions in parentheses are millimeters (mm)



HIGH PRESSURE EQUIPMENT

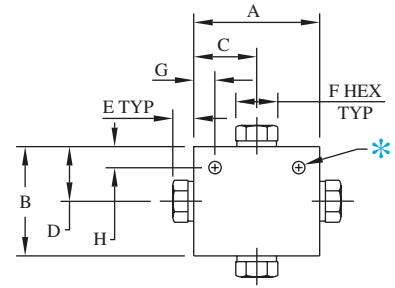
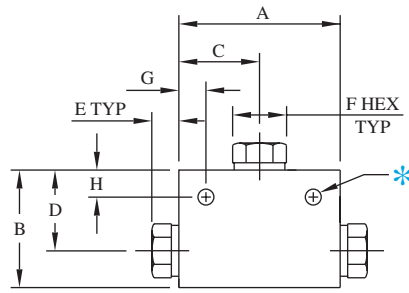
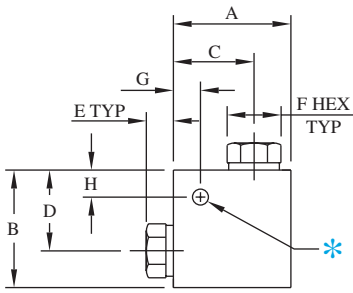

ELBOWS

Catalog											Mounting Holes*		
Number	Connection	Port	MAWP	A	B	C	D	E	F	Block Thickness	G	H	Dia.
60L4	1/4" H/P Tube	0.093" (2.4)	60,000 PSI 4140 bar	1.50" (38.1)	1.00" (25.4)	0.88" (22.4)	0.63" (16.0)	0.50" (12.7)	0.62" (15.7)	1.00" (25.4)	0.25" (6.4)	0.15" (3.8)	0.22" (5.6)
60L6	3/8" H/P Tube	0.125" (3.2)	60,000 PSI 4140 bar	2.00" (50.8)	1.50" (38.1)	1.25" (31.8)	1.00" (25.4)	0.60" (15.2)	0.81" (20.6)	1.00" (25.4)	0.38" (9.7)	0.31" (7.9)	0.22" (5.6)
60L9	9/16" H/P Tube	0.187" (4.7)	60,000 PSI 4140 bar	2.62" (66.5)	1.88" (47.8)	1.88" (47.8)	1.13" (28.6)	0.81" (20.6)	1.18" (30.0)	1.50" (38.1)	2.32" (58.9)	1.38" (35.1)	0.28" (7.1)
40L9	9/16" H/P Tube	0.250" (6.4)	40,000 PSI 2760 bar	2.62" (66.5)	1.88" (47.8)	1.88" (47.8)	1.13" (28.7)	0.81" (20.6)	1.18" (30.0)	1.50" (38.1)	2.37" (60.2)	1.62" (41.1)	0.28" (7.1)
30L16	1" H/P Tube	0.438" (11.1)	30,000 PSI 2070 bar	3.00" (76.2)	3.00" (76.2)	2.06" (52.3)	2.06" (52.3)	0.72" (18.3)	1.38" (35.1)	1.75" (44.5)	0.69" (17.5)	0.69" (17.5)	0.41" (10.3)

TEES

Catalog											Mounting Holes*		
Number	Connection	Port	MAWP	A	B	C	D	E	F	Block Thickness	G	H	Dia.
60T4	1/4" H/P Tube	0.093" (2.4)	60,000 PSI 4140 bar	2.00" (50.8)	1.25" (31.8)	1.00" (25.4)	0.88" (22.4)	0.50" (12.7)	0.62" (15.7)	1.00" (25.4)	0.25" (6.4)	0.12" (3.0)	0.17" (4.3)
60T6	3/8" H/P Tube	0.125" (3.2)	60,000 PSI 4140 bar	2.00" (50.8)	1.56" (39.6)	1.00" (25.4)	1.06" (26.9)	0.60" (15.2)	0.81" (20.6)	1.00" (25.4)	0.31" (7.9)	0.31" (7.9)	0.22" (5.6)
60T9	9/16" H/P Tube	0.187" (4.7)	60,000 PSI 4140 bar	2.62" (66.5)	2.12" (53.8)	1.31" (33.3)	1.38" (35.1)	0.81" (20.6)	1.18" (30.0)	1.50" (38.1)	0.37" (9.4)	0.38" (9.5)	0.28" (7.1)
40T9	9/16" H/P Tube	0.250" (6.4)	40,000 PSI 2760 bar	2.62" (66.5)	2.12" (53.8)	1.31" (33.3)	1.38" (35.1)	0.81" (20.6)	1.18" (30.0)	1.50" (38.1)	0.37" (9.4)	0.38" (9.7)	0.28" (7.1)
30T16	1" H/P Tube	0.438" (11.1)	30,000 PSI 2070 bar	4.12" (104.6)	3.00" (76.2)	2.06" (52.3)	2.06" (52.3)	0.72" (18.3)	1.38" (35.1)	1.75" (44.5)	0.69" (17.5)	0.69" (17.5)	0.41" (10.4)

CROSSES

Catalog											Mounting Holes*		
Number	Connection	Port	MAWP	A	B	C	D	E	F	Block Thickness	G	H	Dia.
60X4	1/4" H/P Tube	0.093" (2.4)	60,000 PSI 4140 bar	2.00" (50.8)	1.25" (31.8)	1.00" (25.4)	0.62" (15.7)	0.50" (12.7)	0.62" (15.7)	1.00" (25.4)	0.25" (6.4)	0.12" (3.0)	0.17" (4.3)
60X6	3/8" H/P Tube	0.125" (3.2)	60,000 PSI 4140 bar	2.00" (50.8)	2.12" (53.8)	1.00" (25.4)	1.06" (26.9)	0.60" (15.2)	0.81" (20.6)	1.00" (25.4)	0.31" (7.9)	0.31" (7.9)	0.22" (5.6)
60X9	9/16" H/P Tube	0.187" (4.7)	60,000 PSI 4140 bar	2.62" (66.5)	2.75" (69.9)	1.31" (33.3)	1.38" (35.1)	0.81" (20.6)	1.18" (30.0)	1.50" (38.1)	0.38" (9.7)	0.38" (9.5)	0.28" (7.1)
40X9	9/16" H/P Tube	0.250" (6.4)	40,000 PSI 2760 bar	2.62" (66.5)	2.75" (69.9)	1.31" (33.3)	1.38" (35.1)	0.81" (20.6)	1.18" (30.0)	1.50" (38.1)	0.37" (9.4)	0.38" (9.7)	0.28" (7.1)
30X16	1" H/P Tube	0.438" (11.1)	30,000 PSI 2070 bar	4.12" (104.6)	4.12" (104.6)	2.06" (52.3)	2.06" (52.3)	0.72" (18.3)	1.38" (35.1)	1.75" (44.5)	0.69" (17.5)	0.69" (17.5)	0.41" (10.3)

*Mounting holes provided when the catalog number is suffixed by "-MH" when ordering.

All dimensions are for reference only and are subject to change.
Dimensions in parentheses are millimeters (mm)



HIGH PRESSURE EQUIPMENT

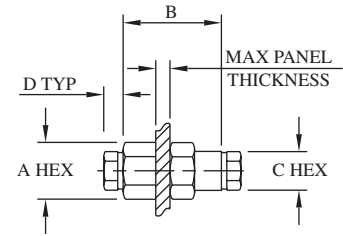
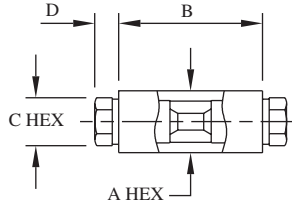
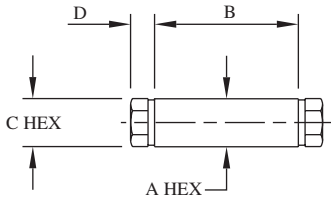

See bulkhead table below for panel hole drill size

COUPLINGS

Catalog Number	Connection	Port	MAWP	A	B	C	D
60F4	1/4" H/P Tube	0.093" (2.4)	60,000 PSI 4140 bar	0.75" (19.1)	1.38" (35.1)	0.63" (16.0)	0.50" (12.7)
60F6	3/8" H/P Tube	0.125" (3.2)	60,000 PSI 4140 bar	1.00" (25.4)	1.75" (44.5)	0.81" (20.6)	0.60" (15.2)
60F9	9/16" H/P Tube	0.187" (4.7)	60,000 PSI 4140 bar	1.37" (34.8)	2.25" (57.2)	1.18" (30.0)	0.81" (20.6)
40F9	9/16" H/P Tube	0.250" (6.4)	40,000 PSI 2760 bar	1.37" (34.8)	2.25" (57.2)	1.18" (30.0)	0.81" (20.6)
30F16	1" H/P Tube	0.438" (11.1)	30,000 PSI 2070 bar	1.75" (44.5)	3.75" (95.3)	1.38" (35.1)	0.72" (18.3)

REPLACEABLE SEAT COUPLINGS

Catalog Number	Connection	Port	MAWP	A	B	C	D
60UF4	1/4" H/P Tube	0.093" (2.4)	60,000 PSI 4140 bar	0.75" (19.1)	1.50" (38.1)	0.63" (16.0)	0.50" (12.7)
60UF6	3/8" H/P Tube	0.125" (3.2)	60,000 PSI 4140 bar	1.38" (35.1)	1.75" (44.5)	0.81" (20.6)	0.60" (15.2)
60UF9	9/16" H/P Tube	0.187" (4.7)	60,000 PSI 4140 bar	1.38" (35.1)	2.25" (57.2)	1.18" (30.0)	0.81" (20.6)
40UF9	9/16" H/P Tube	0.250" (6.4)	40,000 PSI 2760 bar	1.38" (35.1)	2.25" (57.2)	1.18" (30.0)	0.81" (20.6)
30UF16	1" H/P Tube	0.438" (11.1)	30,000 PSI 2070 bar	1.75" (44.5)	3.75" (95.3)	1.38" (35.1)	0.72" (18.3)

BULKHEADS

Catalog Number	Connection	Port	MAWP	A	B	C	D	Max Panel Thickness	Panel Hole
60BF4	1/4" H/P Tube	0.093" (2.4)	60,000 PSI 4140 bar	1.00" (25.4)	2.00" (50.8)	0.63" (16.0)	0.50" (12.7)	0.50" (12.7)	0.94" (23.0)
60BF6	3/8" H/P Tube	0.125" (3.2)	60,000 PSI 4140 bar	1.38" (35.1)	2.38" (60.5)	0.81" (20.6)	0.60" (15.2)	0.38" (9.7)	1.12" (28.4)
60BF9	9/16" H/P Tube	0.187" (4.7)	60,000 PSI 4140 bar	1.87" (47.5)	2.75" (69.9)	1.18" (30.0)	0.81" (20.6)	0.62" (15.7)	1.75" (44.5)
40BF9	9/16" H/P Tube	0.250" (6.4)	40,000 PSI 2760 bar	1.87" (47.5)	2.75" (69.9)	1.18" (30.0)	0.81" (20.6)	0.62" (15.7)	1.75" (44.5)
30BF16	1" H/P Tube	0.438" (11.1)	30,000 PSI 2070 bar	2.12" (53.8)	3.50" (88.9)	1.38" (35.1)	0.72" (18.3)	0.50" (12.7)	2.00" (50.8)

All dimensions are for reference only and are subject to change.
Dimensions in parentheses are millimeters (mm)



HIGH PRESSURE NIPPLES AND TUBING

Coned and Threaded Nipples

BuTech stocks pre-cut coned and threaded nipples in lengths up to 12" (305 mm). In addition, nipples can be purchased to any custom length.

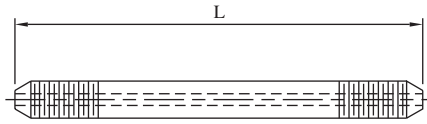

Connection	Length							MAWP
	2.75" (69.9)	3.00" (76.2)	4.00" (101.6)	6.00" (152.4)	8.00" (203.2)	10.00" (254.0)	12.00" (304.8)	
1/4" H/P	60N442-*	60N443-*	60N444-*	60N446-*	60N448-*	60N4410-*	60N4412-*	60,000 PSI 4140 bar
3/8" H/P		60N663-*	60N664-*	60N666-*	60N668-*	60N6610-*	60N6612-*	60,000 PSI 4140 bar
9/16" H/P 0.188" orifice			60N994-*	60N996-*	60N998-*	60N9910-*	60N9912-*	60,000 PSI 4140 bar
9/16" H/P 0.250" orifice			40N994-*	40N996-*	40N998-*	40N9910-*	40N9912-*	40,000 PSI 2760 bar
1" H/P				30N166-*	30N168-*	30N1610-*	30N1612-*	30,000 PSI 2070 bar

*Complete catalog number by adding suffix **316** for 316 stainless steel or suffix **304** for 304 stainless steel

Tubing

Catalog Number	Connection	O.D.	I.D.	MAWP
60-083-*	1/4" H/P	0.250" (6.4)	0.083" (2.1)	60,000 PSI 4140 bar
60-125-*	3/8" H/P	0.375" (9.5)	0.125" (3.2)	60,000 PSI 4140 bar
60-188-*	9/16" H/P	0.562" (14.3)	0.188" (4.8)	60,000 PSI 4140 bar
40-250-*	9/16" H/P	0.562" (14.3)	0.250" (6.4)	40,000 PSI 2760 bar
30-438-*	1" H/P	1.000" (25.4)	0.438" (11.1)	30,000 PSI 2070 bar

*Complete catalog number by adding suffix **316** for 316 stainless steel or suffix **304** for 304 stainless steel. Other materials are also available, please consult factory.

BuTech offers a complete selection of austenitic seamless cold-drawn stainless steel tubing for high pressure applications where both high strength and corrosion resistance are desired. Tubing is available in standard 20-24 foot lengths (6-7 meters), however, longer lengths are available on request.



See Section T for Coning Tools, Threading Tools and Tube Vises!

HIGH PRESSURE CONNECTION COMPONENTS

Connection Components

All BuTech valves and fittings are supplied with glands and collars. To order these components separately, use catalog numbers listed below. When using a plug, the collar is not required.

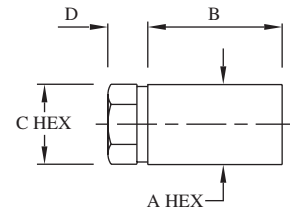

Tube Size	Collar	Gland	Plug
1/4" H/P	60C4	60G4	60P4
3/8" H/P	60C6	60G6	60P6
9/16" H/P 60,000 PSI	60C9	60G9	60P9
9/16" H/P 40,000 PSI	60C9	60G9	40P9
1" H/P	20C16	20G16	30P16

Cap	A	B	C	D
60CA4	0.75" (19.1)	1.06" (26.9)	0.63" (16.0)	0.60" (15.2)
60CA6	1.00" (25.4)	1.25" (31.8)	0.81" (20.6)	0.72" (18.3)
60CA9	1.38" (35.1)	1.62" (41.1)	1.18" (30.0)	0.96" (24.4)
40CA9	1.38" (35.1)	1.62" (41.1)	1.18" (30.0)	0.96" (24.4)
30CA16	1.75" (44.5)	2.25" (57.2)	1.38" (35.1)	0.69" (17.5)

Anti-Vibration Collet Glands

In standard high pressure connection systems, the bending stresses imposed by excessive vibration or shock on the the threaded area of the tubing may cause premature fatigue failure at the back of the thread. By using a BuTech Anti-Vibration Collet Gland, the stress concentration is transferred back to the unthreaded section of the tubing. This transfer and the spring-type gripping action of the collet, strengthens the entire assembly, resulting in virtually unlimited vibration fatigue life. Anti-Vibration Collet Glands are recommended whenever locating a valve or fitting on an unsupported line near a compressor, on equipment subjected to road vibrations, or areas where extreme shock is present.

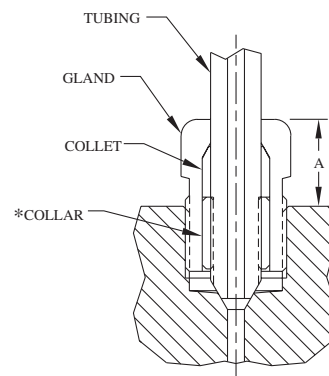

For 1/4", 3/8" & 9/16" Tube

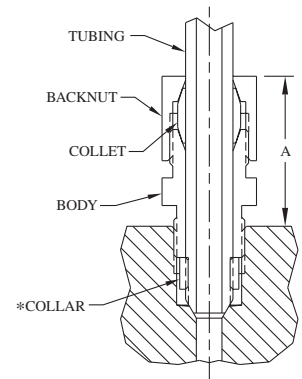

For 1" Tube

Connection	Catalog Number	Gland Hex Size	Height 'A'	Collar*
1/4" H/P	60AVG4	0.62" (15.7)	0.50" (12.7)	60C4
3/8" H/P	60AVG6	0.81" (20.6)	0.75" (19.1)	60C6
9/16" H/P	60AVG9	1.18" (30.0)	0.94" (23.9)	60C9
1" H/P	20AVCG16	1.50" (38.1)	1.75" (44.5)	20C16

Anti-vibration glands are manufactured of 316 stainless steel and are available with an optional bonded dry-film Moly lubricant (add suffix **-MC** to catalog number)

*Collars are not included with anti-vibration assembly and must be ordered separately.



All dimensions are for reference only and are subject to change.
Dimensions in parentheses are millimeters (mm)

HIGH PRESSURE CHECK VALVES

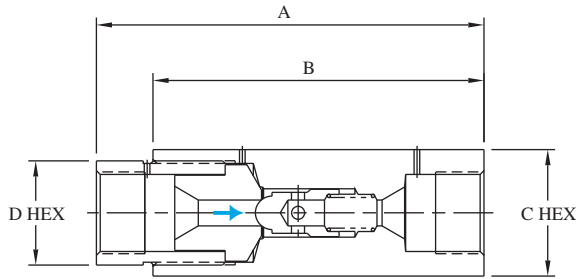

BuTech ball check valves prevent reverse flow where leak-tight shutoff is not necessary. Standard materials of construction are 316 stainless steel with 17-4PH poppet for longer life, and 300 series stainless steel spring.

Note: For 316ss wetted parts, add **-316WP** to the catalog number.

Cracking pressure: 15 PSI (1 bar) approximate

Operating Temperature Range:

-420° to +1200°F

(-251° to +648°C)

BALL CHECK VALVES

Catalog Number	Connection	MAWP	Cv	A	B	C	D
60BC4	1/4" H/P Tube	60,000 PSI 4140 bar	0.15	3.31" (84.1)	2.50" (63.5)	1.12" (28.4)	0.88" (22.2)
60BC6	3/8" H/P Tube	60,000 PSI 4140 bar	0.28	3.75" (95.3)	3.00" (76.2)	1.38" (34.9)	1.12" (28.4)
60BC9	9/16" H/P Tube	60,000 PSI 4140 bar	0.63	4.57" (116.1)	3.38" (85.9)	1.50" (38.1)	1.38" (34.9)
40BC9	9/16" H/P Tube	40,000 PSI 2760 bar	1.00	4.57" (116.1)	3.38" (85.9)	1.50" (38.1)	1.38" (35.1)
30BC16	1" H/P Tube	30,000 PSI 2070 bar	3.40	6.50" (165.1)	5.55" (141.0)	1.75" (44.5)	2.13" (54.1)

To order a valve with a cracking pressure other than the standard 15 PSI, add the cracking pressure to the end of the catalog number. Example: A 60BC9 with 50 PSI cracking pressure would be ordered as **60BC9-50**.

Cracking pressures available up to 100 PSI (7 bar)

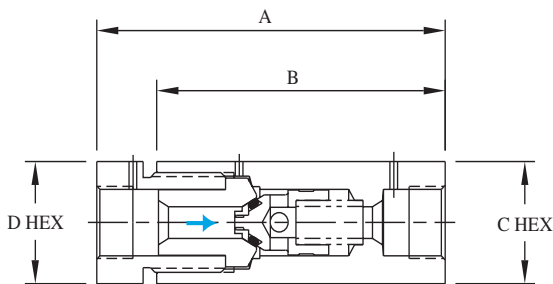

BuTech o-ring check valves reliably prevent backflow where leak-tight shutoff for liquids or gases is required. Standard materials of construction are 316 stainless steel with Buna-N o-ring and 300 series stainless steel spring.

Cracking pressure: 15 PSI (1 bar) approximate

Operating Temperature Ranges:

O-ring Material	Operating Temperature Range	Catalog Suffix
Buna-N	-65° to +250°F (-54° to +121°C)	----
Viton	-40° to +500°F (-40° to +260°C)	-VA
Teflon	-320° to +400°F (-195° to +204°C)	-TFE
Kalrez	-20° to +550°F (-29° to +288°C)	-HT

O-RING CHECK VALVES

Catalog Number	Connection	MAWP	Cv	A	B	C	D
60SC4	1/4" H/P Tube	60,000 PSI 4140 bar	0.15	3.31" (84.1)	2.50" (63.5)	1.12" (28.4)	0.88" (22.2)
60SC6	3/8" H/P Tube	60,000 PSI 4140 bar	0.28	3.75" (95.3)	3.00" (76.2)	1.38" (34.9)	1.12" (28.4)
60SC9	9/16" H/P Tube	60,000 PSI 4140 bar	0.63	4.57" (116.1)	3.38" (85.9)	1.50" (38.1)	1.38" (34.9)
40SC9	9/16" H/P Tube	40,000 PSI 2760 bar	1.00	4.57" (116.1)	3.38" (85.9)	1.50" (38.1)	1.38" (35.1)
30SC16	1" H/P Tube	30,000 PSI 2070 bar	3.40	6.50" (165.1)	5.55" (141.0)	2.13" (54.1)	1.75" (44.5)

To order a valve with a cracking pressure other than the standard 15 PSI, add the cracking pressure to the end of the catalog number. Example: A 60SC4 with 40 PSI cracking pressure would be ordered as **60SC4-40**.

Cracking pressures available up to 100 PSI (7 bar)

All dimensions are for reference only and are subject to change.
Dimensions in parentheses are millimeters (mm)

HIGH PRESSURE FILTERS

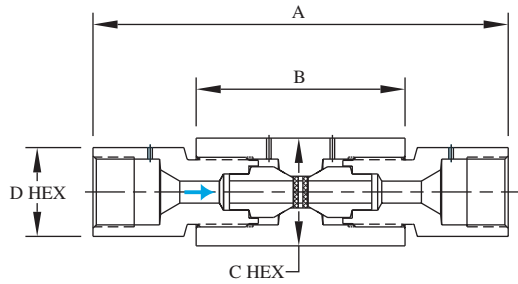

BuTech line filters are used in system lines to remove contaminating particles from the system fluid. Upstream filter of larger micron rating than downstream filter to prevent clogging of downstream filter.

Standard materials of construction are 316 stainless steel with 300 series stainless steel filter discs. Available in nominal ratings of: 0.5, 2, 5, 10, 20, 40, and 100 micron.

LINE FILTERS

Catalog Number	Connection	MAWP	Area*	A	B	C	D
60LF4	1/4" H/P Tube	60,000 PSI 4140 bar	0.15 in ² 97 mm ²	4.06" (103.1)	2.62" (66.5)	1.38" (34.9)	0.88" (22.4)
60LF6	3/8" H/P Tube	60,000 PSI 4140 bar	0.15 in ² 97 mm ²	4.56" (115.8)	2.62" (66.5)	1.38" (34.9)	1.00" (25.4)
60LF9	9/16" H/P Tube	60,000 PSI 4140 bar	0.15 in ² 97 mm ²	6.00" (152.4)	3.62" (91.9)	1.50" (38.1)	1.38" (35.1)
40LF9	9/16" H/P Tube	40,000 PSI 2760 bar	0.22 in ² 142 mm ²	6.00" (152.4)	3.62" (91.9)	1.50" (38.1)	1.38" (35.1)
30LF16	1" H/P Tube	30,000 PSI 2070 bar	0.50 in ² 323 mm ²	8.18" (207.8)	4.12" (104.6)	2.13" (54.1)	1.75" (44.5)

*Effective area of filter element

Micron rating of filter must be specified. To order, complete the catalog number with the desired micron rating, upstream first:

60LF4-40/20

specifies a line filter with 1/4" H/P connections, a 40 micron filter upstream and 20 micron downstream.

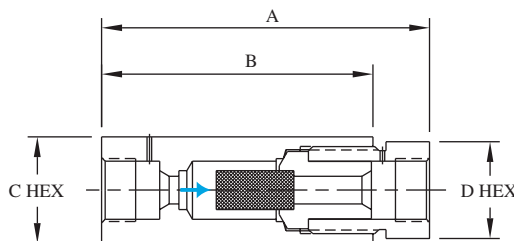

BuTech sintered cup filters offer maximum filtration surface area for removal of contaminating particles from the fluid system. They may be used in systems which require high flow rates with minimum pressure drop.

Standard materials of construction are 316 stainless steel with 300 series stainless steel filter discs. Available in nominal ratings of: 5, 10, 20, 40, and 100 micron.

SINTERED CUP FILTERS

Catalog Number	Connection	MAWP	Area*	A	B	C	D
60SCF4	1/4" H/P Tube	60,000 PSI 4140 bar	0.44 in ² 284 mm ²	3.32" (84.3)	2.50" (63.5)	1.12" (28.4)	0.88" (22.2)
60SCF6	3/8" H/P Tube	60,000 PSI 4140 bar	0.54 in ² 348 mm ²	3.75" (95.3)	3.00" (76.2)	1.38" (34.9)	1.12" (28.4)
60SCF9	9/16" H/P Tube	60,000 PSI 4140 bar	0.86 in ² 555 mm ²	4.70" (119.4)	3.37" (85.6)	1.50" (38.1)	1.38" (34.9)
40SCF9	9/16" H/P Tube	40,000 PSI 2760 bar	1.47 in ² 948 mm ²	6.00" (152.4)	3.62" (91.9)	1.50" (38.1)	1.38" (35.1)
30SCF16	1" H/P Tube	30,000 PSI 2070 bar	1.75 in ² 1129 mm ²	6.50" (165.1)	5.55" (141.0)	2.13" (54.1)	1.75" (44.5)

*Effective area of filter element

Micron rating of filter must be specified. To order, complete the catalog number with the desired micron rating:

60SCF4-20

specifies a line filter with 1/4" H/P connections and a 20 micron filter.



All dimensions are for reference only and are subject to change.
Dimensions in parentheses are millimeters (mm)

HIGH PRESSURE SAFETY HEADS & RUPTURE DISCS

BuTech safety head assemblies serve as holders for standard rupture discs (sold separately). Safety heads with rupture discs are used as simple and inexpensive overpressure relief devices. System pressure is relieved as a result of rupture of the replaceable disc.

The safety head assemblies shown are designed for use in high pressure systems up to 60,000 PSI (4140 bar). They can be installed directly into any of our standard couplings, elbows, tees, or crosses. Their versatility also allows direct installation into a standard 3-way valve. The result is a combination valve/safety head with beneficial cost and space advantages.

Standard material of construction is 316 stainless steel.

Safety head assemblies and rupture discs are available in two styles:

The **1/4A** style features a 1/4" blow-out diameter, an angular seat and can be ordered in pressures from 900 to 60,000 PSI (62 to 4140 bar)

The **1/2F** style features a 1/2" blow-out diameter, a flat seat and can be ordered in pressures from 500 to 10,000 PSI (34 to 689 bar). This style also has a reversible hold-down ring which greatly reduces the possibility of premature disc failure associated with installation errors inherent in some designs.

Rupture discs are available in a wide range of burst ratings. Factors such as corrosion, fatigue and temperature may affect the burst pressure of the disc and cause premature failure. This problem may sometimes be overcome by frequent replacement of the disc. All discs rated over 500 PSI (34 bar) have a manufacturing tolerance of 3% under to 6% over the specified rupture pressure rating.

Rupture Discs are not included in the safety head assembly. To order discs separately, use the following part numbering system:

Style	Material	Pressure:
4=1/4" Angled	AL=Aluminum	List desired pressure at 72°F
8=1/2" Flat	IN=Inconel	(21°C) in KSI.
	MO=Monel	
	NI=Nickel	
	SI=Silver	
	SS=316SS	
	TI=Titanium	

Examples:

An Inconel disc rated for 18,000 PSI in 1/4" Angled style would be ordered as **4IN18.00**

An Aluminum disc rated for 750 PSI in 1/2" Flat style would be ordered as **8AL0.750**

SAFETY HEADS - 1/4" ANGLED DISC

Catalog Number	Connection	MAWP	A	B	C	Discharge
60SH4-1/4A	1/4" H/P Tube	60,000 PSI 4140 bar	1.00" (25.4)	2.75" (69.9)	1.00" (25.4)	3/8" FNPT
60SH6-1/4A	3/8" H/P Tube	60,000 PSI 4140 bar	1.00" (25.4)	2.81" (71.4)	1.00" (25.4)	3/8" FNPT
60SH9-1/4A	9/16" H/P Tube	60,000 PSI 4140 bar	1.38" (35.1)	2.88" (73.0)	1.00" (25.4)	3/8" FNPT
40SH9-1/4A	9/16" H/P Tube	40,000 PSI 2760 bar	1.38" (35.1)	2.88" (73.2)	1.00" (25.4)	3/8" FNPT
30SH16-1/4A	1" H/P Tube	30,000 PSI 2070 bar	1.75" (44.5)	3.38" (85.9)	1.00" (25.4)	3/8" FNPT

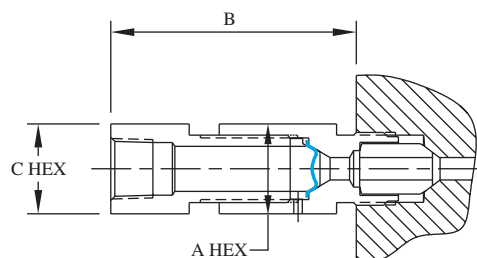

SAFETY HEADS - 1/2" FLAT DISC

Catalog Number	Connection	MAWP	A	B	C	Discharge
60SH4-1/2F	1/4" H/P Tube	10,000 PSI 689 bar	1.00" (25.4)	2.68" (68.1)	1.00" (25.4)	3/8" FNPT
60SH6-1/2F	3/8" H/P Tube	10,000 PSI 689 bar	1.00" (25.4)	2.81" (71.4)	1.00" (25.4)	3/8" FNPT
60SH9-1/2F	9/16" H/P Tube	10,000 PSI 689 bar	1.38" (35.1)	2.81" (71.4)	1.00" (25.4)	3/8" FNPT
40SH9-1/2F	9/16" H/P Tube	10,000 PSI 689 bar	1.38" (35.1)	2.81" (71.4)	1.00" (25.4)	3/8" FNPT
30SH16-1/2F	1" H/P Tube	10,000 PSI 689 bar	1.75" (44.5)	3.38" (85.9)	1.00" (25.4)	3/8" FNPT

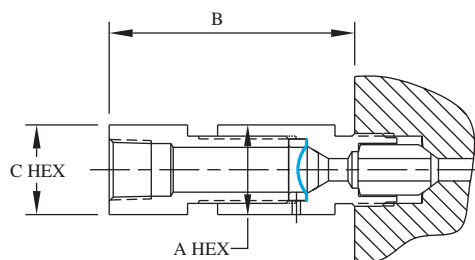

All dimensions are for reference only and are subject to change.
Dimensions in parentheses are millimeters (mm)

EQUIPMENT FOR 150,000 PSI (10,340 BAR)

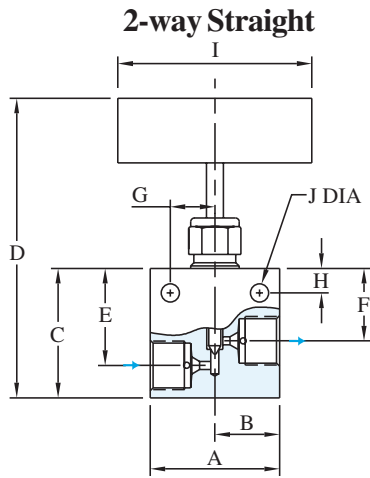

Figure 1

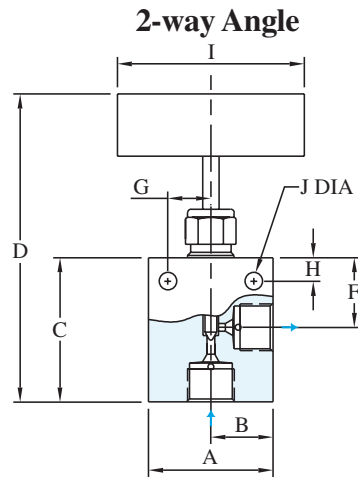

Figure 2

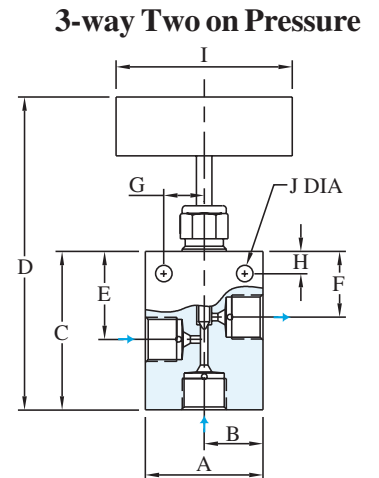
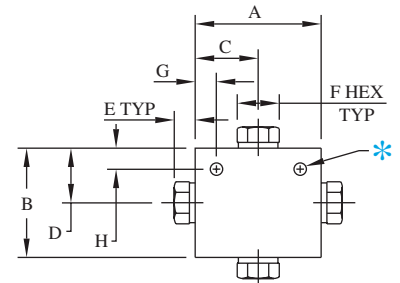
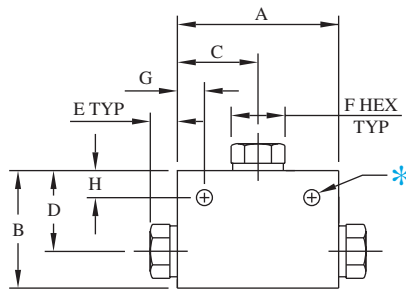
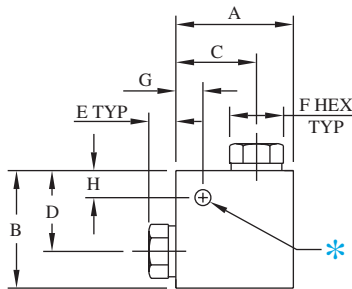

Figure 3

Catalog Number	Stem Style	Connection	Orifice	Cv	A	B	C	D	E	F	G	H	I	J	Thk.	Fig.
150V51V	Vee	5/16" H/P	0.094"	0.27	3.00"	1.50"	2.50"	5.66"	1.75"	1.44"	0.87"	0.50"	3.00"	0.34"	1.50"	1
150V51R	Reg	Tube	(2.4)		(76.2)	(38.1)	(63.5)	(143.8)	(44.5)	(36.6)	(22.1)	(12.7)	(76.2)	(8.6)	(38.1)	
150V52V	Vee	5/16" H/P	0.094"	0.40	3.00"	1.50"	2.88"	6.27"	---	1.44"	0.87"	0.50"	3.00"	0.34"	1.50"	2
150V52R	Reg	Tube	(2.4)		(76.2)	(38.1)	(73.2)	(159.3)		(36.6)	(22.1)	(12.7)	(76.2)	(8.6)	(38.1)	
150V53V	Vee	5/16" H/P	0.094"	0.40	3.00"	1.50"	3.19"	6.35"	1.75"	1.44"	0.87"	0.50"	3.00"	0.34"	1.50"	3
150V53R	Reg	Tube	(2.4)		(76.2)	(38.1)	(81.0)	(161.3)	(44.5)	(36.6)	(22.1)	(12.7)	(76.2)	(8.6)	(38.1)	



ELBOW

Catalog Number	Connection	Port	MAWP	A	B	C	D	E	F	Block Thickness	Mounting Holes*		
											G	H	Dia.
150L5	5/16" H/P Tube	0.062"	150,000 PSI 10340 bar	2.25"	2.00"	1.75"	1.38"	0.62"	0.75"	1.50"	0.50"	0.50"	0.34"
		(1.6)		(57.2)	(50.8)	(44.5)	(35.1)	(15.7)	(19.1)	(38.1)	(12.7)	(12.7)	(8.6)

TEE

Catalog Number	Connection	Port	MAWP	A	B	C	D	E	F	Block Thickness	Mounting Holes*		
											G	H	Dia.
150T5	5/16" H/P Tube	0.062"	150,000 PSI 10340 bar	3.00"	2.25"	1.50"	1.62"	0.62"	0.75"	1.50"	0.50"	0.50"	0.34"
		(1.6)		(76.2)	(57.2)	(38.1)	(41.1)	(15.7)	(19.1)	(38.1)	(12.7)	(12.7)	(8.6)

CROSS

Catalog Number	Connection	Port	MAWP	A	B	C	D	E	F	Block Thickness	Mounting Holes*		
											G	H	Dia.
150X5	5/16" H/P Tube	0.062"	150,000 PSI 10340 bar	3.00"	3.00"	1.50"	1.50"	0.62"	0.75"	1.50"	0.50"	0.50"	0.34"
		(1.6)		(76.2)	(76.2)	(38.1)	(38.1)	(15.7)	(19.1)	(38.1)	(12.7)	(12.7)	(8.6)

*Mounting holes provided when the catalog number is suffixed by "-MH" when ordering.



All dimensions are for reference only and are subject to change.
Dimensions in parentheses are millimeters (mm)

EQUIPMENT FOR 150,000 PSI (10,340 BAR)

COUPLING

Catalog							
Number	Connection	Port	MAWP	A	B	C	D
150F5	5/16" H/P Tube	0.062" (1.6)	150,000 PSI 10340 bar	1.12" (28.4)	2.62" (66.5)	0.75" (19.1)	0.62" (15.7)

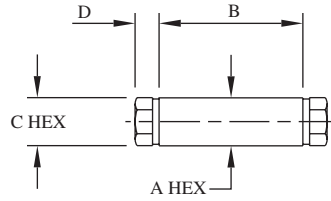

REPLACEABLE SEAT COUPLING

Catalog							
Number	Connection	Port	MAWP	A	B	C	D
150UF5	5/16" H/P Tube	0.062" (1.6)	150,000 PSI 10340 bar	1.12" (28.4)	2.62" (66.5)	0.75" (19.1)	0.62" (15.7)

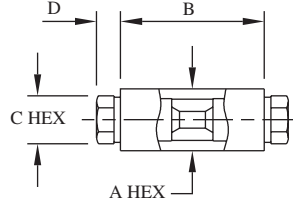

BULKHEAD

Catalog								Max Panel	Panel
Number	Connection	Port	MAWP	A	B	C	D	Thickness	Hole
150BF5	5/16" H/P Tube	0.062" (1.6)	150,000 PSI 10340 bar	1.75" (44.5)	3.25" (82.6)	0.75" (19.1)	0.62" (15.7)	0.50" (12.7)	1.44" (36.6)

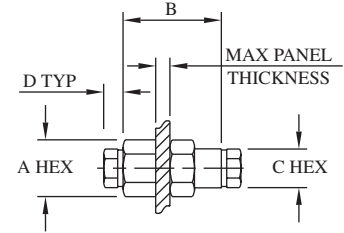

Connection Components

All BuTech valves and fittings are supplied with glands and collars. To order these components separately, use catalog numbers listed below. When using a plug, the collar is not required.



Tube Size	Collar	Gland	Plug
5/16" H/P	150C5	150G5	150P5

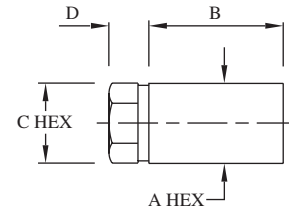

Cap	A	B	C	D
150CA5	1.12" (28.4)	1.50" (38.1)	0.75" (19.1)	0.62" (15.7)

Coned and Threaded Nipples

BuTech stocks pre-cut coned and threaded nipples in lengths up to 12" (305 mm). In addition, nipples can be purchased to any custom

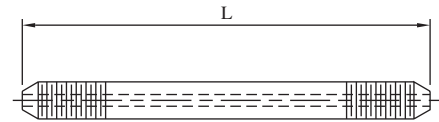

Connection	Length					MAWP
	4.00" (101.6)	6.00" (152.4)	8.00" (203.2)	10.00" (254.0)	12.00" (304.8)	
5/16" H/P	150N554-316	150N556-316	150N558-316	150N5510-316	150N5512-316	150,000 PSI 10340 bar

Tubing

Catalog				
Number	Connection	O.D.	I.D.	MAWP
150-063-316	5/16" H/P	0.312" (7.9)	0.063" (1.6)	150,000 PSI 10340 bar

BuTech offers a complete selection of austenitic seamless cold-drawn stainless steel tubing for high pressure applications where both high strength and corrosion resistance are desired. Tubing is available in standard 20-24 foot lengths (6-7 meters), however, longer lengths are available on request.

All dimensions are for reference only and are subject to change.
Dimensions in parentheses are millimeters (mm)

SPECIALTY PRODUCTS

BuTech specializes in equipment custom designed to meet the requirements of new processes, harsh environments and severe applications. We can provide solutions for the extreme conditions of pressure, temperature, corrosion and erosion in all machineable alloys.

Manifolds

Custom designed manifolds provide multiple port and connection combinations to meet specific application requirements.

Custom Valves

Individually engineered valves are designed to meet specific application requirements.



SPECIALTY PRODUCTS

Manifolds

Specialty pressure manifolds minimize space requirements and reduce installation time necessary to plumb a pressure system. In addition, by reducing the number of components used in a system, manifolds reduce the number of potential leak joints.

BuTech will design and build pressure manifolds to meet specific installation, layout and pressure requirements. These manifolds are capable of withstanding pressures from vacuum to 60,000 PSI (4140 bar), and are available in a variety of materials and sizes. Among the pressure connections that can be incorporated are low pressure compression, medium and high pressure cone-and-thread, NPT, SAE, BSP and others. Transitions in system line sizes and tubing pressure series can be accomplished through a specialty manifold. These manifolds are appropriate wherever pressure tubing systems are utilized.



Custom Valves

BuTech will individually engineer valves to meet specific application requirements including metric connections and special materials. BuTech also offers a line of valves designed specifically for use in power generating plants.

ACTUATOR SELECTION GUIDE

Valve Model			Normally Open, Air-to-Close Actuators			Normally Closed, Air-to-Open Actuators			Double-Acting Pneumatic Actuators			Double-Acting Hydraulic Actuators	
			ATC5	ATC8	2XATC5	ATO5	ATO8	2XATO5	DA5	DA8	2XDA5	DAH	DAH2
SLPV4 SLPV6	MAWP	PSI bar	12,000 830			11,500 790			12,000 830			12,000 830	
	Req'd Actuator Pressure	PSI bar	59 4.1			82 5.7			38 2.6			355 20	
SLPV6 SLPV8	MAWP	PSI bar	6,000 410			5,500 380			6,000 410			6,000 410	
	Req'd Actuator Pressure	PSI bar	41 2.8			75 5.2			29 2.0			277 20	
DHP2 DHP4 DHP6 DHP8	MAWP	PSI bar	15,000 1030			15,000 1030	15,000 1030		15,000 1030			15,000 1030	
	Req'd Actuator Pressure	PSI bar	59 4.1			81 5.6	50 3.4		47 3.2			444 30	
DHP12 DHP16	MAWP	PSI bar		8,000 550	6,000 410		5,000 340	4,250 290		9,000 620	5,000 340		10,000 690
	Req'd Actuator Pressure	PSI bar		100 6.9	95 6.5		66 4.6	79 5.4		100 6.9	91 6.3		1,400 100.0
SFPV2 SFPV4	MAWP	PSI bar	15,000 1030			15,000 1030			15,000 1030			15,000 1030	
	Req'd Actuator Pressure	PSI bar	59 4.1			81 5.6			47 3.2			444 31.0	
SFPV6 SFPV8	MAWP	PSI bar	15,000 1030	15,000 1030	15,000 1030	14,000 970	15,000 1030		15,000 1030			15,000 1030	
	Req'd Actuator Pressure	PSI bar	85 5.9	40 2.8	40 2.8	84 5.8	56 3.9		73 5.0			693 48.0	
FPV12 FPV16	MAWP	PSI bar		12,000 830	9,000 620		7,500 520	6,500 450		13,000 900	8,000 550		15,000 1030
	Req'd Actuator Pressure	PSI bar		100 6.9	96 6.6		66 4.6	78 5.4		96 6.6	96 6.6		1,406 100.0
20UV4 20UV6	MAWP	PSI bar	20,000 1380			20,000 1380	20,000 1380		20,000 1380			20,000 1380	
	Req'd Actuator Pressure	PSI bar	74 5.1			82 5.7	55 3.8		63 4.3			592 41.0	
20UV9	MAWP	PSI bar	18,000 1240	20,000 1380	20,000 1380	14,000 970	20,000 1380	20,000 1380	20,000 1380		20,000 1380	20,000 1380	
	Req'd Actuator Pressure	PSI bar	100 6.9	49 3.4	55 3.8	84 5.8	58 4.0	67 4.6	98 6.8		67 5.0	925 64.0	
20V12	MAWP	PSI bar		20,000 1380	14,000 970		12,500 860	10,500 720		20,000 1380	12,000 830		20,000 1380
	Req'd Actuator Pressure	PSI bar		101 7.0	90 6.2		66 4.6	79 5.4		90 6.2	89 6.1		1,134 80.0
20V16	MAWP	PSI bar		12,000 830	8,000 550		7,500 520			12,000 830			16,000 1100
	Req'd Actuator Pressure	PSI bar		100 6.9	52 3.6		66 4.6			89 6.1			1,500 100.0
30UV	MAWP	PSI bar	30,000 2070			30,000 2070			30,000 2070			30,000 2070	
	Req'd Actuator Pressure	PSI bar	35 2.4			78 5.4			23 1.6			222 15.3	
30V	MAWP	PSI bar		18,000 1240	15,000 1030		12,500 860			22,000 1520	12,000 830		26,000 1790
	Req'd Actuator Pressure	PSI bar		92 6.3	96 6.6		66 4.6			99 6.8	89 6.1		1,475 100.0
40UV	MAWP	PSI bar	40,000 2760			40,000 2760			40,000 2760			40,000 2760	
	Req'd Actuator Pressure	PSI bar	36 2.5			78 5.4			24 1.7			227 15.6	
60UV	MAWP	PSI bar	60,000 4140			60,000 4140			60,000 4140			60,000 4140	
	Req'd Actuator Pressure	PSI bar	23 1.6			88 6.1			12 0.8			111 8.0	
150V	MAWP	PSI bar	150,000 10340	150,000 10340		150,000 10340	150,000 10340		150,000 10340			150,000 10340	
	Req'd Actuator Pressure	PSI bar	78 5.4	37 2.6		86 5.9	54 3.7		66 4.6			624 43.0	

All dimensions are for reference only and are subject to change without notice.
Dimensions in parentheses are millimeters (mm).



5" AIR-TO-CLOSE

Model ATC5

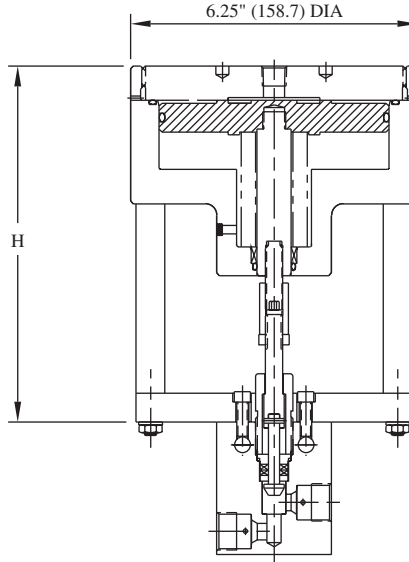

System Pressure - PSI (bar)

Valve Model	H	3,000 (210)	4,000 (280)	5,000 (340)	6,000 (410)	7,000 (480)	8,000 (550)	9,000 (620)	10,000 (690)	11,000 (760)	12,000 (830)
SLPV4	7.31" (185.7)	21 PSI 1.5 bar	24 PSI 1.7 bar	27 PSI 1.9 bar	30 PSI 2.1 bar	34 PSI 2.3 bar	37 PSI 2.6 bar	40 PSI 2.8 bar	43 PSI 3.0 bar	46 PSI 3.2 bar	49 PSI 3.4 bar
SLPV6											
SLPV8	7.75" (196.9)	26 PSI 1.8 bar	31 PSI 2.1 bar	36 PSI 2.5 bar	41 PSI 2.8 bar						

Valve Model	H	2,000 (140)	4,000 (280)	5,000 (340)	6,000 (410)	7,000 (480)	8,000 (550)	10,000 (690)	12,000 (830)	14,000 (970)	15,000 (1030)
DHP2	7.31" (185.7)	18 PSI	24 PSI	27 PSI	30 PSI	34 PSI	37 PSI	43 PSI	49 PSI	55 PSI	59 PSI
DHP4		1.2 bar	1.7 bar	1.9 bar	2.1 bar	2.3 bar	2.6 bar	3.0 bar	3.4 bar	3.8 bar	4.1 bar
DHP6											
DHP8											
SFPV2	7.31" (185.7)	18 PSI	24 PSI	27 PSI	30 PSI	34 PSI	37 PSI	43 PSI	49 PSI	55 PSI	59 PSI
SFPV4		1.2 bar	1.7 bar	1.9 bar	2.1 bar	2.3 bar	2.6 bar	3.0 bar	3.4 bar	3.8 bar	4.1 bar
SFPV6	7.75" (196.9)	21 PSI	31 PSI	36 PSI	41 PSI	46 PSI	51 PSI	61 PSI	70 PSI	80 PSI	85 PSI
SFPV8		1.5 bar	2.1 bar	2.5 bar	2.8 bar	3.2 bar	3.5 bar	4.2 bar	4.8 bar	5.5 bar	5.9 bar

Valve Model	H	2,000 (140)	4,000 (280)	6,000 (410)	8,000 (550)	10,000 (690)	12,000 (830)	14,000 (970)	16,000 (1100)	18,000 (1240)	20,000 (1380)
20UV4	7.31" (185.7)	18 PSI	24 PSI	30 PSI	37 PSI	43 PSI	49 PSI	55 PSI	62 PSI	68 PSI	74 PSI
20UV6		1.2 bar	1.7 bar	2.1 bar	2.6 bar	3.0 bar	3.4 bar	3.8 bar	4.3 bar	4.7 bar	5.1 bar
20UV9	7.75" (196.9)	21 PSI	31 PSI	41 PSI	51 PSI	61 PSI	70 PSI	80 PSI	90 PSI	100 PSI	
		1.5 bar	2.1 bar	2.8 bar	3.5 bar	4.2 bar	4.8 bar	5.5 bar	6.2 bar	6.9 bar	

Valve Model	H	15,000 (1030)	20,000 (1380)	25,000 (1720)	30,000 (2070)	35,000 (2410)	40,000 (2760)	45,000 (3100)	50,000 (3450)	55,000 (3790)	60,000 (4140)
30UV	7.31" (185.7)	23 PSI 1.6 bar	27 PSI 1.9 bar	31 PSI 2.1 bar	35 PSI 2.4 bar						
40UV	7.31" (185.7)	21 PSI 1.5 bar	24 PSI 1.7 bar	27 PSI 1.9 bar	30 PSI 2.1 bar	33 PSI 2.3 bar	36 PSI 2.5 bar				
60UV	7.31" (185.7)	15 PSI 1.0 bar	16 PSI 1.1 bar	17 PSI 1.2 bar	18 PSI 1.2 bar	19 PSI 1.3 bar	20 PSI 1.4 bar	21 PSI 1.5 bar	21 PSI 1.5 bar	22 PSI 1.5 bar	23 PSI 1.6 bar

Valve Model	H	60,000 (4140)	70,000 (4830)	80,000 (5520)	90,000 (6200)	100,000 (6890)	110,000 (7580)	120,000 (8270)	130,000 (8960)	140,000 (9650)	150,000 (10340)
150V	7.37" (187.2)	38 PSI 2.6 bar	42 PSI 2.9 bar	47 PSI 3.2 bar	51 PSI 3.5 bar	56 PSI 3.9 bar	60 PSI 4.1 bar	64 PSI 4.4 bar	69 PSI 4.8 bar	73 PSI 5.0 bar	78 PSI 5.4 bar

All dimensions are for reference only and are subject to change without notice.
Dimensions in parentheses are millimeters (mm).

8" AIR-TO-CLOSE

Model ATC8

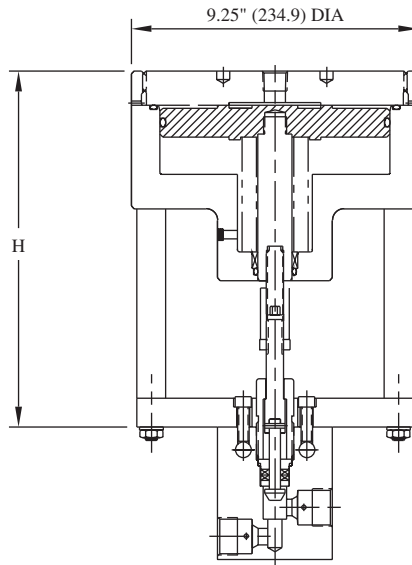

System Pressure - PSI (bar)

Valve Model	H	2,000 (140)	4,000 (280)	5,000 (340)	6,000 (410)	7,000 (480)	8,000 (550)	10,000 (690)	12,000 (830)	14,000 (970)	15,000 (1030)
DHP12	8.44" (214.4)	33 PSI 2.3 bar	55 PSI 3.8 bar	67 PSI 4.6 bar	78 PSI 5.4 bar	89 PSI 6.1 bar	100 PSI 6.9 bar				
SFPV6	7.88" (200.2)	15 PSI 1.0 bar	19 PSI 1.3 bar	21 PSI 1.5 bar	23 PSI 1.6 bar	24 PSI 1.7 bar	26 PSI 1.8 bar	30 PSI 2.1 bar	34 PSI 2.3 bar	38 PSI 2.6 bar	40 PSI 2.8 bar
FPV12	9.06" (230.1)	26 PSI 1.8 bar	41 PSI 2.8 bar	48 PSI 3.3 bar	56 PSI 3.9 bar	63 PSI 4.3 bar	70 PSI 4.8 bar	85 PSI 5.9 bar	100 PSI 6.9 bar		

Valve Model	H	2,000 (140)	4,000 (280)	6,000 (410)	8,000 (550)	10,000 (690)	12,000 (830)	14,000 (970)	16,000 (1100)	18,000 (1240)	20,000 (1380)
20UV9	8.00" (203.2)	15 PSI 1.0 bar	19 PSI 1.3 bar	23 PSI 1.6 bar	26 PSI 1.8 bar	30 PSI 2.1 bar	34 PSI 2.3 bar	38 PSI 2.6 bar	42 PSI 2.9 bar	45 PSI 3.1 bar	49 PSI 3.4 bar
20V12	8.00" (203.2)	20 PSI 1.4 bar	29 PSI 2.0 bar	38 PSI 2.6 bar	47 PSI 3.2 bar	56 PSI 3.9 bar	65 PSI 4.5 bar	74 PSI 5.1 bar	83 PSI 5.7 bar	92 PSI 6.3 bar	101 PSI 7.0 bar
20V16	9.06" (230.1)	26 PSI 1.8 bar	41 PSI 2.8 bar	56 PSI 3.9 bar	70 PSI 4.8 bar	85 PSI 5.9 bar	100 PSI 6.9 bar				

Valve Model	H	12,000 (830)	14,000 (970)	16,000 (1100)	18,000 (1240)	20,000 (1380)	22,000 (1520)	24,000 (1650)	26,000 (1790)	28,000 (1930)	30,000 (2070)
30V16	8.25" (209.6)	65 PSI 4.5 bar	74 PSI 5.1 bar	83 PSI 5.7 bar	92 PSI 6.3 bar						

Valve Model	H	60,000 (4140)	70,000 (4830)	80,000 (5520)	90,000 (6200)	100,000 (6890)	110,000 (7580)	120,000 (8270)	130,000 (8960)	140,000 (9650)	150,000 (10340)
150V	7.38" (187.5)	21 PSI 1.5 bar	23 PSI 1.6 bar	25 PSI 1.7 bar	27 PSI 1.9 bar	28 PSI 1.9 bar	30 PSI 2.1 bar	32 PSI 2.2 bar	33 PSI 2.3 bar	35 PSI 2.4 bar	37 PSI 2.6 bar

All dimensions are for reference only and are subject to change without notice.
Dimensions in parentheses are millimeters (mm).



5" DOUBLE-PISTON AIR-TO-CLOSE

Model 2XATC5

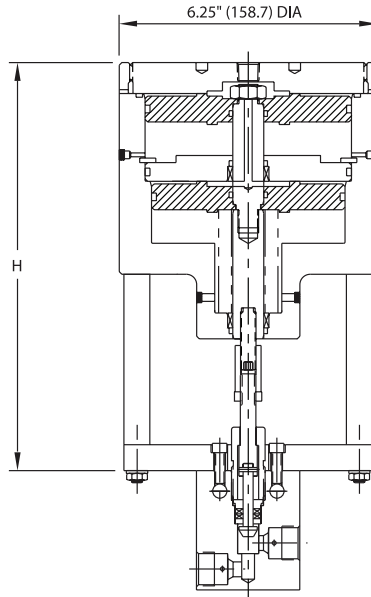

System Pressure - PSI (bar)

Valve Model	H	3,000 (210)	4,000 (280)	5,000 (340)	6,000 (410)	7,000 (480)	8,000 (550)	9,000 (620)	10,000 (690)	11,000 (760)	12,000 (830)
SLPV4	7.31" (185.7)	21 PSI 1.5 bar	24 PSI 1.7 bar	27 PSI 1.9 bar	30 PSI 2.1 bar	34 PSI 2.3 bar	37 PSI 2.6 bar	40 PSI 2.8 bar	43 PSI 3.0 bar	46 PSI 3.2 bar	49 PSI 3.4 bar
SLPV6											
SLPV8	7.75" (196.9)	26 PSI 1.8 bar	31 PSI 2.1 bar	36 PSI 2.5 bar	41 PSI 2.8 bar						

Valve Model	H	2,000 (140)	4,000 (280)	5,000 (340)	6,000 (410)	7,000 (480)	8,000 (550)	10,000 (690)	12,000 (830)	14,000 (970)	15,000 (1030)
DHP2	7.31" (185.7)	18 PSI	24 PSI	27 PSI	30 PSI	34 PSI	37 PSI	43 PSI	49 PSI	55 PSI	59 PSI
DHP4		1.2 bar	1.7 bar	1.9 bar	2.1 bar	2.3 bar	2.6 bar	3.0 bar	3.4 bar	3.8 bar	4.1 bar
DHP6											
DHP8											
SFPV2	7.31" (185.7)	18 PSI	24 PSI	27 PSI	30 PSI	34 PSI	37 PSI	43 PSI	49 PSI	55 PSI	59 PSI
SFPV4		1.2 bar	1.7 bar	1.9 bar	2.1 bar	2.3 bar	2.6 bar	3.0 bar	3.4 bar	3.8 bar	4.1 bar
SFPV6	7.75" (196.9)	21 PSI	31 PSI	36 PSI	41 PSI	46 PSI	51 PSI	61 PSI	70 PSI	80 PSI	85 PSI
SFPV8		1.5 bar	2.1 bar	2.5 bar	2.8 bar	3.2 bar	3.5 bar	4.2 bar	4.8 bar	5.5 bar	5.9 bar

Valve Model	H	2,000 (140)	4,000 (280)	6,000 (410)	8,000 (550)	10,000 (690)	12,000 (830)	14,000 (970)	16,000 (1100)	18,000 (1240)	20,000 (1380)
20UV4	7.31" (185.7)	18 PSI	24 PSI	30 PSI	37 PSI	43 PSI	49 PSI	55 PSI	62 PSI	68 PSI	74 PSI
20UV6		1.2 bar	1.7 bar	2.1 bar	2.6 bar	3.0 bar	3.4 bar	3.8 bar	4.3 bar	4.7 bar	5.1 bar
20UV9	7.75" (196.9)	21 PSI	31 PSI	41 PSI	51 PSI	61 PSI	70 PSI	80 PSI	90 PSI	100 PSI	
		1.5 bar	2.1 bar	2.8 bar	3.5 bar	4.2 bar	4.8 bar	5.5 bar	6.2 bar	6.9 bar	

Valve Model	H	15,000 (1030)	20,000 (1380)	25,000 (1720)	30,000 (2070)	35,000 (2410)	40,000 (2760)	45,000 (3100)	50,000 (3450)	55,000 (3790)	60,000 (4140)
30UV	7.31" (185.7)	23 PSI	27 PSI	31 PSI	35 PSI						
		1.6 bar	1.9 bar	2.1 bar	2.4 bar						
40UV	7.31" (185.7)	21 PSI	24 PSI	27 PSI	30 PSI	33 PSI	36 PSI				
		1.5 bar	1.7 bar	1.9 bar	2.1 bar	2.3 bar	2.5 bar				
60UV	7.31" (185.7)	15 PSI	16 PSI	17 PSI	18 PSI	19 PSI	20 PSI	21 PSI	21 PSI	22 PSI	23 PSI
		1.0 bar	1.1 bar	1.2 bar	1.2 bar	1.3 bar	1.4 bar	1.5 bar	1.5 bar	1.5 bar	1.6 bar

Valve Model	H	60,000 (4140)	70,000 (4830)	80,000 (5520)	90,000 (6200)	100,000 (6890)	110,000 (7580)	120,000 (8270)	130,000 (8960)	140,000 (9650)	150,000 (10340)
150V	7.37" (187.2)	38 PSI	42 PSI	47 PSI	51 PSI	56 PSI	60 PSI	64 PSI	69 PSI	73 PSI	78 PSI
		2.6 bar	2.9 bar	3.2 bar	3.5 bar	3.9 bar	4.1 bar	4.4 bar	4.8 bar	5.0 bar	5.4 bar

All dimensions are for reference only and are subject to change without notice.
Dimensions in parentheses are millimeters (mm).

5" AIR-TO-OPEN

Model ATO5

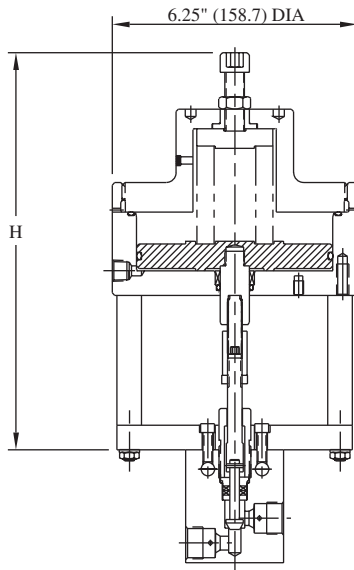

Valve Model	H		Spring Compression						
			1/8"	3/16"	1/4"	5/16"	3/8"	7/16"	1/2"
SLPV4 SLPV6	8.00" (203.2)	MAWP	8,500 586 bar	11,000 758 bar	11,500 793 bar				
		Required Air Pressure	76 PSI 5.2 bar	76 PSI 5.2 bar	82 PSI 5.7 bar				
SLPV8	8.00" (203.2)	MAWP	5,500 379 bar						
		Required Air Pressure	75 PSI 5.2 bar						
DHP2 DHP4 DHP6 DHP8	8.00" (203.2)	MAWP	8,500 586 bar	11,000 758 bar	13,000 896 bar	15,000 1034 bar			
		Required Air Pressure	76 PSI 5.2 bar	76 PSI 5.2 bar	79 PSI 5.5 bar	81 PSI 5.6 bar			
SFPV2 SFPV4	8.00" (203.2)	MAWP	8,500 586 bar	11,000 758 bar	13,000 896 bar	15,000 1034 bar			
		Required Air Pressure	76 PSI 5.2 bar	76 PSI 5.2 bar	79 PSI 5.5 bar	81 PSI 5.6 bar			
SFPV6 SFPV8	8.00" (203.2)	MAWP	5,500 379 bar	7,000 483 bar	8,500 586 bar	10,000 689 bar	11,000 758 bar	12,500 862 bar	14,000 965 bar
		Required Air Pressure	75 PSI 5.2 bar	77 PSI 5.3 bar	78 PSI 5.4 bar	79 PSI 5.5 bar	82 PSI 5.7 bar	83 PSI 5.7 bar	84 PSI 5.8 bar
20UV4 20UV6	8.00" (203.2)	MAWP	8,500 586 bar	11,000 758 bar	13,000 896 bar	15,500 1069 bar	17,500 1207 bar	20,000 1379 bar	
		Required Air Pressure	76 PSI 5.2 bar	76 PSI 5.2 bar	79 PSI 5.5 bar	79 PSI 5.5 bar	81 PSI 5.6 bar	82 PSI 5.7 bar	
20UV9	8.00" (203.2)	MAWP	5,500 379 bar	7,000 483 bar	8,500 586 bar	10,000 689 bar	11,000 758 bar	12,500 862 bar	14,000 965 bar
		Required Air Pressure	75 PSI 5.2 bar	77 PSI 5.3 bar	78 PSI 5.4 bar	79 PSI 5.5 bar	82 PSI 5.7 bar	83 PSI 5.7 bar	84 PSI 5.8 bar
30UV	8.00" (203.2)	MAWP	30,000 2068 bar						
		Required Air Pressure	78 PSI 5.4 bar						
40UV	8.00" (203.2)	MAWP	40,000 2758 bar						
		Required Air Pressure	78 PSI 5.4 bar						
60UV	8.00" (203.2)	MAWP	60,000 4136 bar						
		Required Air Pressure	88 PSI 6.1 bar						
150V	8.19" (208.0)	MAWP	60,000 4136 bar	75,000 5171 bar	95,000 6549 bar	100,000 6894 bar	125,000 8618 bar	140,000 9652 bar	150,000 10341 bar
		Required Air Pressure	76 PSI 5.2 bar	78 PSI 5.4 bar	78 PSI 5.4 bar	83 PSI 5.7 bar	81 PSI 5.6 bar	83 PSI 5.7 bar	86 PSI 5.9 bar

All dimensions are for reference only and are subject to change without notice.
Dimensions in parentheses are millimeters (mm).



8" AIR-TO-OPEN

Model ATO8

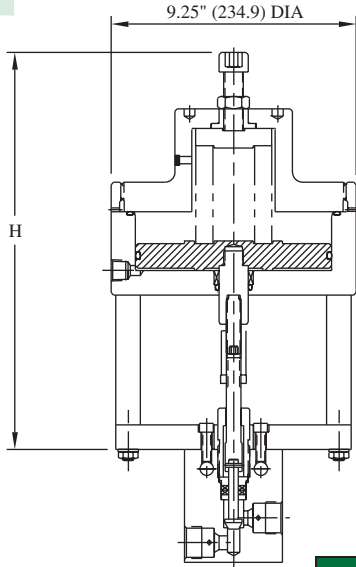

Valve Model	H		Spring Compression									
			1/8"	3/16"	1/4"	5/16"	3/8"	7/16"	1/2"	9/16"	5/8"	
DHP2 DHP4 DHP6 DHP8	8.50" (215.9)	MAWP	15,000 1034 bar									
Required Air Pressure		50 PSI 3.5 bar										
DHP12 DHP16	9.38" (238.3)	MAWP	1,500 103 bar	2,000 138 bar	2,000 138 bar	2,500 172 bar	3,000 207 bar	3,500 241 bar	4,000 276 bar	4,500 310 bar	5,000 345 bar	
Required Air Pressure		54 PSI 3.7 bar	55 PSI 3.8 bar	60 PSI 4.1 bar	61 PSI 4.2 bar	62 PSI 4.3 bar	63 PSI 4.3 bar	64 PSI 4.4 bar	65 PSI 4.5 bar	66 PSI 4.6 bar		
SFPV6 SFPV8	8.69" (220.7)	MAWP	9,500 655 bar	12,000 827 bar	14,500 1000 bar	15,000 1034 bar						
Required Air Pressure		50 PSI 3.5 bar	51 PSI 3.5 bar	52 PSI 3.6 bar	56 PSI 3.9 bar							
FPV12 FPV16	10.63" (270.0)	MAWP	2,500 172 bar	3,000 207 bar	3,500 241 bar	4,000 276 bar	5,000 345 bar	5,500 379 bar	6,000 414 bar	7,000 483 bar	7,500 517 bar	
Required Air Pressure		53 PSI 3.7 bar	55 PSI 3.8 bar	57 PSI 3.9 bar	60 PSI 4.1 bar	59 PSI 4.1 bar	62 PSI 4.3 bar	64 PSI 4.4 bar	64 PSI 4.4 bar	66 PSI 4.6 bar		
20UV4 20UV6	8.12" (206.2)	MAWP	15,000 1034 bar	19,000 1310 bar	20,000 1379 bar							
Required Air Pressure		50 PSI 3.5 bar	51 PSI 3.5 bar	55 PSI 3.8 bar								
20UV9	10.00" (254.0)	MAWP	9,500 655 bar	12,000 827 bar	14,500 1000 bar	17,000 1172 bar	19,500 1344 bar	20,000 1379 bar				
Required Air Pressure		50 PSI 3.5 bar	51 PSI 3.5 bar	52 PSI 3.6 bar	53 PSI 3.7 bar	54 PSI 3.7 bar	58 PSI 4.0 bar					
20V12	8.50" (215.9)	MAWP	4,000 276 bar	5,000 345 bar	6,000 414 bar	7,000 483 bar	8,000 552 bar	9,500 655 bar	10,500 724 bar	11,500 793 bar	12,500 862 bar	
Required Air Pressure		53 PSI 3.7 bar	55 PSI 3.8 bar	57 PSI 3.9 bar	58 PSI 4.0 bar	60 PSI 4.1 bar	62 PSI 4.3 bar	64 PSI 4.4 bar	64 PSI 4.4 bar	66 PSI 4.6 bar		
20V16	10.50" (266.7)	MAWP	2,500 172 bar	3,000 207 bar	3,500 241 bar	4,000 276 bar	5,000 345 bar	5,500 379 bar	6,000 414 bar	7,000 483 bar	7,500 517 bar	
Required Air Pressure		53 PSI 3.7 bar	55 PSI 3.8 bar	57 PSI 3.9 bar	60 PSI 4.1 bar	59 PSI 4.1 bar	62 PSI 4.3 bar	64 PSI 4.4 bar	64 PSI 4.4 bar	66 PSI 4.6 bar		
30V16	9.03" (229.4)	MAWP	4,000 276 bar	5,000 345 bar	6,000 414 bar	7,000 483 bar	8,000 552 bar	9,500 655 bar	10,500 724 bar	11,500 793 bar	12,500 862 bar	
Required Air Pressure		53 PSI 3.7 bar	55 PSI 3.8 bar	57 PSI 3.9 bar	58 PSI 4.0 bar	60 PSI 4.1 bar	60 PSI 4.1 bar	62 PSI 4.3 bar	64 PSI 4.4 bar	66 PSI 4.6 bar		
150V	9.19" (233.4)	MAWP	110,000 7583 bar	135,000 9307 bar	150,000 10341 bar							
Required Air Pressure		50 PSI 3.5 bar	51 PSI 3.5 bar	54 PSI 3.7 bar								

All dimensions are for reference only and are subject to change without notice.
Dimensions in parentheses are millimeters (mm).

5" DOUBLE-PISTON AIR-TO-OPEN

Model 2XATO5

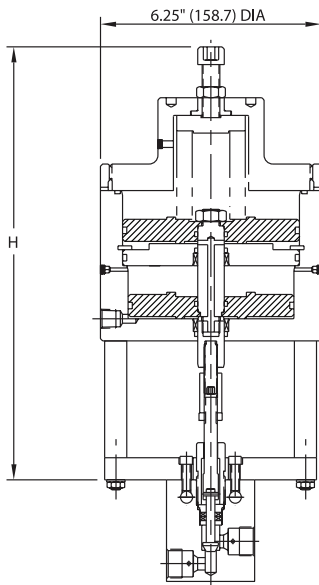

Valve Model	H		Spring Compression						
			1/8"	3/16"	1/4"	5/16"	3/8"	7/16"	1/2"
SLPV4 SLPV6	8.00" (203.2)	MAWP	8,500 586 bar	11,000 758 bar	11,500 793 bar				
		Required Air Pressure	76 PSI 5.2 bar	76 PSI 5.2 bar	82 PSI 5.7 bar				
SLPV8	8.00" (203.2)	MAWP	5,500 379 bar						
		Required Air Pressure	75 PSI 5.2 bar						
DHP2 DHP4 DHP6 DHP8	8.00" (203.2)	MAWP	8,500 586 bar	11,000 758 bar	13,000 896 bar	15,000 1034 bar			
		Required Air Pressure	76 PSI 5.2 bar	76 PSI 5.2 bar	79 PSI 5.5 bar	81 PSI 5.6 bar			
SFPV2 SFPV4	8.00" (203.2)	MAWP	8,500 586 bar	11,000 758 bar	13,000 896 bar	15,000 1034 bar			
		Required Air Pressure	76 PSI 5.2 bar	76 PSI 5.2 bar	79 PSI 5.5 bar	81 PSI 5.6 bar			
SFPV6 SFPV8	8.00" (203.2)	MAWP	5,500 379 bar	7,000 483 bar	8,500 586 bar	10,000 689 bar	11,000 758 bar	12,500 862 bar	14,000 965 bar
		Required Air Pressure	75 PSI 5.2 bar	77 PSI 5.3 bar	78 PSI 5.4 bar	79 PSI 5.5 bar	82 PSI 5.7 bar	83 PSI 5.7 bar	84 PSI 5.8 bar
20UV4 20UV6	8.00" (203.2)	MAWP	8,500 586 bar	11,000 758 bar	13,000 896 bar	15,500 1069 bar	17,500 1207 bar	20,000 1379 bar	
		Required Air Pressure	76 PSI 5.2 bar	76 PSI 5.2 bar	79 PSI 5.5 bar	79 PSI 5.5 bar	81 PSI 5.6 bar	82 PSI 5.7 bar	
20UV9	8.00" (203.2)	MAWP	5,500 379 bar	7,000 483 bar	8,500 586 bar	10,000 689 bar	11,000 758 bar	12,500 862 bar	14,000 965 bar
		Required Air Pressure	75 PSI 5.2 bar	77 PSI 5.3 bar	78 PSI 5.4 bar	79 PSI 5.5 bar	82 PSI 5.7 bar	83 PSI 5.7 bar	84 PSI 5.8 bar
30UV	8.00" (203.2)	MAWP	30,000 2068 bar						
		Required Air Pressure	78 PSI 5.4 bar						
40UV	8.00" (203.2)	MAWP	40,000 2758 bar						
		Required Air Pressure	78 PSI 5.4 bar						
60UV	8.00" (203.2)	MAWP	60,000 4136 bar						
		Required Air Pressure	88 PSI 6.1 bar						
150V	8.19" (208.0)	MAWP	60,000 4136 bar	75,000 5171 bar	95,000 6549 bar	100,000 6894 bar	125,000 8618 bar	140,000 9652 bar	150,000 10341 bar
		Required Air Pressure	76 PSI 5.2 bar	78 PSI 5.4 bar	78 PSI 5.4 bar	83 PSI 5.7 bar	81 PSI 5.6 bar	83 PSI 5.7 bar	86 PSI 5.9 bar

All dimensions are for reference only and are subject to change without notice.
Dimensions in parentheses are millimeters (mm).



5" DOUBLE-ACTING

Model DA5

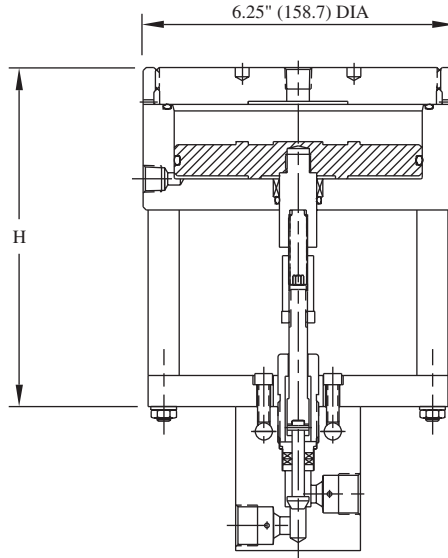

System Pressure - PSI (bar)

Valve Model	H	3,000 (210)	4,000 (280)	5,000 (340)	6,000 (410)	7,000 (480)	8,000 (550)	9,000 (620)	10,000 (690)	11,000 (760)	12,000 (830)
SLPV4	6.13"	9 PSI	13 PSI	16 PSI	19 PSI	22 PSI	25 PSI	28 PSI	31 PSI	34 PSI	38 PSI
SLPV6	(155.7)	0.6 bar	0.9 bar	1.1 bar	1.3 bar	1.5 bar	1.7 bar	1.9 bar	2.1 bar	2.3 bar	2.6 bar
SLPV8	6.88"	15 PSI	20 PSI	24 PSI	29 PSI						
	(174.8)	1.0 bar	1.4 bar	1.7 bar	2.0 bar						

Valve Model	H	2,000 (140)	4,000 (280)	5,000 (340)	6,000 (410)	7,000 (480)	8,000 (550)	10,000 (690)	12,000 (830)	14,000 (970)	15,000 (1030)
DHP2											
DHP4	6.38"	6 PSI	13 PSI	16 PSI	19 PSI	22 PSI	25 PSI	31 PSI	38 PSI	44 PSI	47 PSI
DHP6	(162.1)	0.4 bar	0.9 bar	1.1 bar	1.3 bar	1.5 bar	1.7 bar	2.1 bar	2.6 bar	3.0 bar	3.2 bar
DHP8											
SFPV2	6.12"	6 PSI	13 PSI	16 PSI	19 PSI	22 PSI	25 PSI	31 PSI	38 PSI	44 PSI	47 PSI
SFPV4	(155.4)	0.4 bar	0.9 bar	1.1 bar	1.3 bar	1.5 bar	1.7 bar	2.1 bar	2.6 bar	3.0 bar	3.2 bar
SFPV6	6.12"	10 PSI	20 PSI	24 PSI	29 PSI	34 PSI	39 PSI	49 PSI	59 PSI	68 PSI	73 PSI
SFPV8	(155.4)	0.7 bar	1.4 bar	1.7 bar	2.0 bar	2.3 bar	2.7 bar	3.4 bar	4.1 bar	4.7 bar	5.0 bar

Valve Model	H	2,000 (140)	4,000 (280)	6,000 (410)	8,000 (550)	10,000 (690)	12,000 (830)	14,000 (970)	16,000 (1100)	18,000 (1240)	20,000 (1380)
20UV4	6.12"	6 PSI	13 PSI	19 PSI	25 PSI	31 PSI	38 PSI	44 PSI	50 PSI	56 PSI	63 PSI
20UV6	(155.4)	0.4 bar	0.9 bar	1.3 bar	1.7 bar	2.1 bar	2.6 bar	3.0 bar	3.5 bar	3.9 bar	4.3 bar
20UV9	6.12"	10 PSI	20 PSI	29 PSI	39 PSI	49 PSI	59 PSI	68 PSI	78 PSI	88 PSI	98 PSI
	(155.4)	0.7 bar	1.4 bar	2.0 bar	2.7 bar	3.4 bar	4.1 bar	4.7 bar	5.4 bar	6.1 bar	6.8 bar

Valve Model	H	15,000 (1030)	20,000 (1380)	25,000 (1720)	30,000 (2070)	35,000 (2410)	40,000 (2760)	45,000 (3100)	50,000 (3450)	55,000 (3790)	60,000 (4140)
30UV	7.25"	12 PSI	16 PSI	20 PSI	23 PSI						
	(184.2)	0.8 bar	1.1 bar	1.4 bar	1.6 bar						
40UV	6.12"	9 PSI	12 PSI	15 PSI	18 PSI	21 PSI	24 PSI				
	(155.4)	0.6 bar	0.8 bar	1.0 bar	1.2 bar	1.5 bar	1.7 bar				
60UV	6.12"	3 PSI	4 PSI	5 PSI	6 PSI	7 PSI	8 PSI	9 PSI	10 PSI	11 PSI	12 PSI
	(155.4)	0.2 bar	0.3 bar	0.3 bar	0.4 bar	0.5 bar	0.6 bar	0.6 bar	0.7 bar	0.8 bar	0.8 bar

Valve Model	H	60,000 (4140)	70,000 (4830)	80,000 (5520)	90,000 (6200)	100,000 (6890)	110,000 (7580)	120,000 (8270)	130,000 (8960)	140,000 (9650)	150,000 (10340)
150V	6.31"	26 PSI	31 PSI	35 PSI	40 PSI	44 PSI	48 PSI	53 PSI	57 PSI	62 PSI	66 PSI
	(160.3)	1.8 bar	2.1 bar	2.4 bar	2.8 bar	3.0 bar	3.3 bar	3.7 bar	3.9 bar	4.3 bar	4.6 bar

All dimensions are for reference only and are subject to change without notice.
Dimensions in parentheses are millimeters (mm).

8" DOUBLE-ACTING

Model DA8

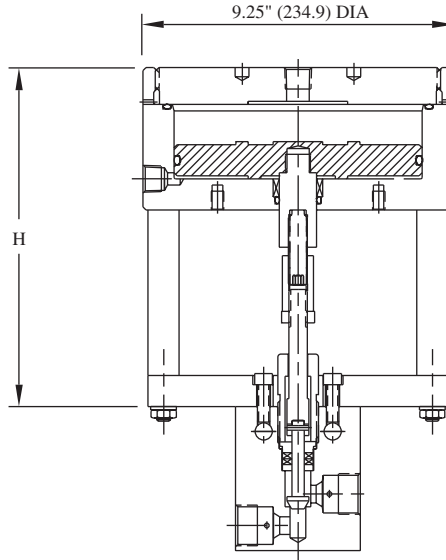

System Pressure - PSI (bar)

Valve Model	H	2,000 (140)	4,000 (280)	5,000 (340)	6,000 (410)	7,000 (480)	8,000 (550)	9,000 (620)	10,000 (690)	12,000 (830)	13,000 (900)
DHP12	7.38" (187.5)	22 PSI 1.5 bar	44 PSI 3.0 bar	55 PSI 3.8 bar	66 PSI 4.6 bar	78 PSI 5.4 bar	89 PSI 6.1 bar	100 PSI 6.9 bar			
DHP16											
FPV12	7.25" (184.2)	15 PSI 1.0 bar	30 PSI 2.1 bar	37 PSI 2.6 bar	44 PSI 3.0 bar	52 PSI 3.6 bar	59 PSI 4.1 bar	67 PSI 4.6 bar	74 PSI 5.1 bar	89 PSI 6.1 bar	96 PSI 6.6 bar
FPV16											

Valve Model	H	2,000 (140)	4,000 (280)	6,000 (410)	8,000 (550)	10,000 (690)	12,000 (830)	14,000 (970)	16,000 (1100)	18,000 (1240)	20,000 (1380)
20V12	6.62" (168.1)	9 PSI 0.6 bar	18 PSI 1.2 bar	27 PSI 1.9 bar	36 PSI 2.5 bar	45 PSI 3.1 bar	54 PSI 3.7 bar	63 PSI 4.3 bar	72 PSI 5.0 bar	81 PSI 5.6 bar	90 PSI 6.2 bar
20V16	7.25" (184.2)	15 PSI 1.0 bar	30 PSI 2.1 bar	44 PSI 3.0 bar	59 PSI 4.1 bar	74 PSI 5.1 bar	89 PSI 6.1 bar				

Valve Model	H	8,000 (550)	10,000 (690)	12,000 (830)	16,000 (1100)	18,000 (1240)	20,000 (1380)	22,000 (1520)	26,000 (1790)	28,000 (1930)	30,000 (2070)
30V16	7.25" (184.2)	36 PSI 2.5 bar	45 PSI 3.1 bar	54 PSI 3.7 bar	72 PSI 5.0 bar	81 PSI 5.6 bar	90 PSI 6.2 bar	99 PSI 6.8 bar			

All dimensions are for reference only and are subject to change without notice.
Dimensions in parentheses are millimeters (mm).



5" DOUBLE-PISTON DOUBLE-ACTING

Model 2XDA5

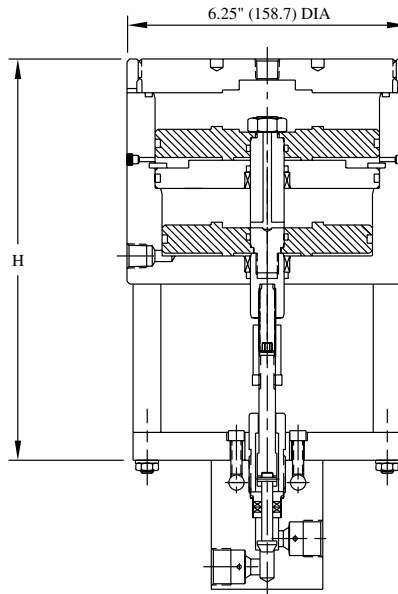

System Pressure - PSI (bar)

Valve Model	H	3,000 (210)	4,000 (280)	5,000 (340)	6,000 (410)	7,000 (480)	8,000 (550)	9,000 (620)	10,000 (690)	11,000 (760)	12,000 (830)
SLPV4	6.13" (155.7)	9 PSI 0.6 bar	13 PSI 0.9 bar	16 PSI 1.1 bar	19 PSI 1.3 bar	22 PSI 1.5 bar	25 PSI 1.7 bar	28 PSI 1.9 bar	31 PSI 2.1 bar	34 PSI 2.3 bar	38 PSI 2.6 bar
SLPV6											
SLPV8	6.88" (174.8)	15 PSI 1.0 bar	20 PSI 1.4 bar	24 PSI 1.7 bar	29 PSI 2.0 bar						

Valve Model	H	2,000 (140)	4,000 (280)	5,000 (340)	6,000 (410)	7,000 (480)	8,000 (550)	10,000 (690)	12,000 (830)	14,000 (970)	15,000 (1030)
DHP2											
DHP4	6.38" (162.1)	6 PSI 0.4 bar	13 PSI 0.9 bar	16 PSI 1.1 bar	19 PSI 1.3 bar	22 PSI 1.5 bar	25 PSI 1.7 bar	31 PSI 2.1 bar	38 PSI 2.6 bar	44 PSI 3.0 bar	47 PSI 3.2 bar
DHP6											
DHP8											
SFPV2	6.12" (155.4)	6 PSI 0.4 bar	13 PSI 0.9 bar	16 PSI 1.1 bar	19 PSI 1.3 bar	22 PSI 1.5 bar	25 PSI 1.7 bar	31 PSI 2.1 bar	38 PSI 2.6 bar	44 PSI 3.0 bar	47 PSI 3.2 bar
SFPV4											
SFPV6	6.12" (155.4)	10 PSI 0.7 bar	20 PSI 1.4 bar	24 PSI 1.7 bar	29 PSI 2.0 bar	34 PSI 2.3 bar	39 PSI 2.7 bar	49 PSI 3.4 bar	59 PSI 4.1 bar	68 PSI 4.7 bar	73 PSI 5.0 bar
SFPV8											

Valve Model	H	2,000 (140)	4,000 (280)	6,000 (410)	8,000 (550)	10,000 (690)	12,000 (830)	14,000 (970)	16,000 (1100)	18,000 (1240)	20,000 (1380)
20UV4	6.12" (155.4)	6 PSI 0.4 bar	13 PSI 0.9 bar	19 PSI 1.3 bar	25 PSI 1.7 bar	31 PSI 2.1 bar	38 PSI 2.6 bar	44 PSI 3.0 bar	50 PSI 3.5 bar	56 PSI 3.9 bar	63 PSI 4.3 bar
20UV6											
20UV9	6.12" (155.4)	10 PSI 0.7 bar	20 PSI 1.4 bar	29 PSI 2.0 bar	39 PSI 2.7 bar	49 PSI 3.4 bar	59 PSI 4.1 bar	68 PSI 4.7 bar	78 PSI 5.4 bar	88 PSI 6.1 bar	98 PSI 6.8 bar

Valve Model	H	15,000 (1030)	20,000 (1380)	25,000 (1720)	30,000 (2070)	35,000 (2410)	40,000 (2760)	45,000 (3100)	50,000 (3450)	55,000 (3790)	60,000 (4140)
30UV	7.25" (184.2)	12 PSI 0.8 bar	16 PSI 1.1 bar	20 PSI 1.4 bar	23 PSI 1.6 bar						
40UV	6.12" (155.4)	9 PSI 0.6 bar	12 PSI 0.8 bar	15 PSI 1.0 bar	18 PSI 1.2 bar	21 PSI 1.5 bar	24 PSI 1.7 bar				
60UV	6.12" (155.4)	3 PSI 0.2 bar	4 PSI 0.3 bar	5 PSI 0.3 bar	6 PSI 0.4 bar	7 PSI 0.5 bar	8 PSI 0.6 bar	9 PSI 0.6 bar	10 PSI 0.7 bar	11 PSI 0.8 bar	12 PSI 0.8 bar

Valve Model	H	60,000 (4140)	70,000 (4830)	80,000 (5520)	90,000 (6200)	100,000 (6890)	110,000 (7580)	120,000 (8270)	130,000 (8960)	140,000 (9650)	150,000 (10340)
150V	6.31" (160.3)	26 PSI 1.8 bar	31 PSI 2.1 bar	35 PSI 2.4 bar	40 PSI 2.8 bar	44 PSI 3.0 bar	48 PSI 3.3 bar	53 PSI 3.7 bar	57 PSI 3.9 bar	62 PSI 4.3 bar	66 PSI 4.6 bar

All dimensions are for reference only and are subject to change without notice.
Dimensions in parentheses are millimeters (mm).

HYDRAULIC ACTUATORS

Model DAH

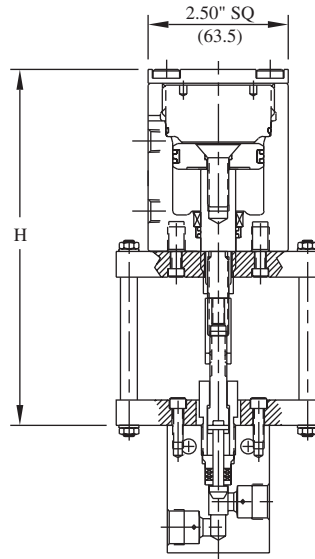

System Pressure - PSI (bar)

Valve Model	H	3,000 (210)	4,000 (280)	5,000 (340)	6,000 (410)	7,000 (480)	8,000 (550)	9,000 (620)	10,000 (690)	11,000 (760)	12,000 (830)
SLPV4	7.12"	89 PSI	118 PSI	148 PSI	178 PSI	207 PSI	237 PSI	266 PSI	296 PSI	325 PSI	355 PSI
SLPV6	(180.8)	6.1 bar	8.1 bar	10.2 bar	12.3 bar	14.3 bar	16.3 bar	18.3 bar	20.4 bar	22.4 bar	24.5 bar
SLPV8	7.12"	139 PSI	185 PSI	231 PSI	277 PSI						
	(180.8)	9.6 bar	12.8 bar	15.9 bar	19.1 bar						

Valve Model	H	2,000 (140)	4,000 (280)	5,000 (340)	6,000 (410)	7,000 (480)	8,000 (550)	10,000 (690)	12,000 (830)	14,000 (970)	15,000 (1030)
DHP2											
DHP4	7.12"	59 PSI	118 PSI	148 PSI	178 PSI	207 PSI	237 PSI	296 PSI	355 PSI	414 PSI	444 PSI
DHP6	(180.8)	4.1 bar	8.1 bar	10.2 bar	12.3 bar	14.3 bar	16.3 bar	20.4 bar	24.5 bar	28.5 bar	30.6 bar
DHP8											
SFPV2	7.12"	59 PSI	118 PSI	148 PSI	178 PSI	207 PSI	237 PSI	296 PSI	355 PSI	414 PSI	444 PSI
SFPV4	(180.8)	4.1 bar	8.1 bar	10.2 bar	12.3 bar	14.3 bar	16.3 bar	20.4 bar	24.5 bar	28.5 bar	30.6 bar
SFPV6	7.12"	92 PSI	185 PSI	231 PSI	277 PSI	324 PSI	370 PSI	462 PSI	555 PSI	647 PSI	693 PSI
SFPV8	(180.8)	6.3 bar	12.8 bar	15.9 bar	19.1 bar	22.3 bar	25.5 bar	31.9 bar	38.3 bar	44.6 bar	47.8 bar

Valve Model	H	2,000 (140)	4,000 (280)	6,000 (410)	8,000 (550)	10,000 (690)	12,000 (830)	14,000 (970)	16,000 (1100)	18,000 (1240)	20,000 (1380)
20UV4	7.12"	59 PSI	118 PSI	178 PSI	237 PSI	296 PSI	355 PSI	414 PSI	473 PSI	533 PSI	592 PSI
20UV6	(180.8)	4.1 bar	8.1 bar	12.3 bar	16.3 bar	20.4 bar	24.5 bar	28.5 bar	32.6 bar	36.8 bar	40.8 bar
20UV9	7.12"	92 PSI	185 PSI	277 PSI	370 PSI	462 PSI	555 PSI	647 PSI	740 PSI	832 PSI	925 PSI
	(180.8)	6.3 bar	12.8 bar	19.1 bar	25.5 bar	31.9 bar	38.3 bar	44.6 bar	51.0 bar	57.4 bar	63.8 bar

Valve Model	H	15,000 (1030)	20,000 (1380)	25,000 (1720)	30,000 (2070)	35,000 (2410)	40,000 (2760)	45,000 (3100)	50,000 (3450)	55,000 (3790)	60,000 (4140)
30UV	7.12"	111 PSI	148 PSI	185 PSI	222 PSI						
	(180.8)	7.7 bar	10.2 bar	12.8 bar	15.3 bar						
40UV	7.12"	85 PSI	113 PSI	142 PSI	170 PSI	198 PSI	227 PSI				
	(180.8)	5.9 bar	7.8 bar	9.8 bar	11.7 bar	13.7 bar	15.7 bar				
60UV	7.12"	28 PSI	37 PSI	46 PSI	55 PSI	65 PSI	74 PSI	83 PSI	92 PSI	102 PSI	111 PSI
	(180.8)	1.9 bar	2.6 bar	3.2 bar	3.8 bar	4.5 bar	5.1 bar	5.7 bar	6.3 bar	7.0 bar	7.7 bar

Valve Model	H	60,000 (4140)	70,000 (4830)	80,000 (5520)	90,000 (6200)	100,000 (6890)	110,000 (7580)	120,000 (8270)	130,000 (8960)	140,000 (9650)	150,000 (10340)
150V	7.12"	250 PSI	291 PSI	333 PSI	374 PSI	416 PSI	458 PSI	499 PSI	541 PSI	582 PSI	624 PSI
	(180.8)	17.2 bar	20.1 bar	23.0 bar	25.8 bar	28.7 bar	31.6 bar	34.4 bar	37.3 bar	40.1 bar	43.0 bar

All dimensions are for reference only and are subject to change without notice.
Dimensions in parentheses are millimeters (mm).



HYDRAULIC ACTUATORS

Model DAH2

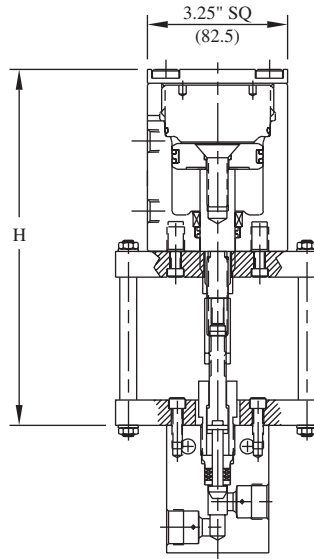

System Pressure - PSI (bar)

Valve Model	H	2,000 (140)	4,000 (280)	6,000 (410)	8,000 (550)	10,000 (690)	11,000 (760)	12,000 (830)	13,000 (900)	14,000 (970)	15,000 (1030)
DHP12	9.00"	280 PSI	560 PSI	840 PSI	1,120 PSI	1,400 PSI					
DHP16	(228.6)	19.3 bar	38.6 bar	57.9 bar	77.2 bar	96.5 bar					
FPV12	8.88"	188 PSI	375 PSI	563 PSI	750 PSI	938 PSI	1,031 PSI	1,125 PSI	1,219 PSI	1,313 PSI	1,406 PSI
FPV16	(225.6)	13.0 bar	25.9 bar	38.8 bar	51.7 bar	64.7 bar	71.1 bar	77.6 bar	84.0 bar	90.5 bar	96.9 bar

Valve Model	H	2,000 (140)	4,000 (280)	6,000 (410)	8,000 (550)	10,000 (690)	12,000 (830)	14,000 (970)	16,000 (1100)	18,000 (1240)	20,000 (1380)
20V12	8.25"	113 PSI	227 PSI	340 PSI	454 PSI	567 PSI	681 PSI	794 PSI	907 PSI	1,021 PSI	1,134 PSI
	(209.6)	7.8 bar	15.7 bar	23.4 bar	31.3 bar	39.1 bar	47.0 bar	54.7 bar	62.5 bar	70.4 bar	78.2 bar
20V16	8.88"	188 PSI	375 PSI	563 PSI	750 PSI	938 PSI	1,125 PSI	1,313 PSI	1,500 PSI		
	(225.6)	13.0 bar	25.9 bar	38.8 bar	51.7 bar	64.7 bar	77.6 bar	90.5 bar	103.4 bar		

Valve Model	H	8,000 (550)	10,000 (690)	12,000 (830)	16,000 (1100)	18,000 (1240)	20,000 (1380)	22,000 (1520)	26,000 (1790)	28,000 (1930)	30,000 (2070)
30V16	8.62"	454 PSI	567 PSI	681 PSI	907 PSI	1,021 PSI	1,134 PSI	1,248 PSI	1,475 PSI		
	(218.9)	31.3 bar	39.1 bar	47.0 bar	62.5 bar	70.4 bar	78.2 bar	86.0 bar	101.7 bar		

All dimensions are for reference only and are subject to change without notice.
Dimensions in parentheses are millimeters (mm).

ADAPTERS, COUPLINGS AND ACCESSORIES

Series	Size	Connection	Size	Connection
Male/Female Adapters LPA 10A 20A 60A Female/Female Couplings LPC 10F 20F 60F Male/Male Adapters MA	1 = 1/16" 2 = 1/8" 4 = 1/4" 6 = 3/8" 8 = 1/2" 9 = 9/16" 12 = 3/4" 16 = 1"	L = LP P = NPT M = M/P H = H/P	1 = 1/16" 2 = 1/8" 4 = 1/4" 6 = 3/8" 8 = 1/2" 9 = 9/16" 12 = 3/4" 16 = 1"	L = LP P = NPT M = M/P H = H/P

Example:
10A4H8P specifies an adapter with 1/4" H/P Male on one end and 1/2" Female NPT on the other

BuTech offers a complete line of adapters and couplings manufactured from 316 cold-worked stainless steel. Pressure gauges, thermocouples and high-pressure hose are also available to complete your system.

In addition to the adapters and couplings shown on the following pages, BuTech also offers adapters with BSP, 37° Flare, SAE O-ring boss, Socket-Weld and Butt-Weld connections. Please contact the sales department.

To determine maximum allowable working pressure (MAWP) of an adapter or coupling:

Locate the rating of each connection in the chart below. The MAWP of the fitting will be the lesser of the two values.

	L/P	NPT	M/P	H/P
1/16"	15,000 PSI 1030 bar			
1/8"	15,000 PSI 1030 bar	15,000 PSI 1030 bar		
1/4"	11,500 PSI 790 bar	15,000 PSI 1030 bar	20,000 PSI 1380 bar	60,000 PSI 4140 bar
3/8"	7,500 PSI 520 bar	15,000 PSI 1030 bar	20,000 PSI 1380 bar	60,000 PSI 4140 bar
1/2"	5,500 PSI 380 bar	15,000 PSI 1030 bar		
9/16"			20,000 PSI 1380 bar	60,000 PSI 4140 bar
3/4"		10,000 PSI 690 bar	20,000 PSI 1380 bar	
1"		10,000 PSI 690 bar	20,000 PSI 1380 bar	

Equipment	Page
Male-Female Adapters	ACC-2
Male-Male Adapters	ACC-9
Couplings	ACC-11
Gauge Snubbers	ACC-15
Hose	ACC-14
Pressure Gauges	ACC-16
Thermocouples	ACC-15

Glands and collars or ferrules included with all female connections



All dimensions are for reference only and are subject to change.
 Dimensions in parentheses are millimeters (mm).



MALE-FEMALE ADAPTERS

Low Pressure Male x Low Pressure Female

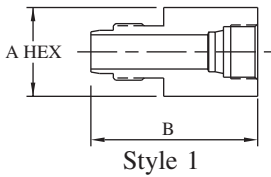

Style 1

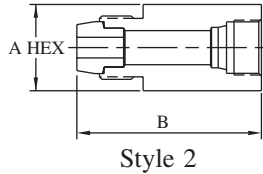

Style 2

Catalog Number	Male L/P	Female L/P	A		B		Port		Style
LPA2L2L	1/8"	1/8"	0.75"	(19.1)	1.50"	(38.1)	0.094"	(2.4)	1
LPA2L4L	1/8"	1/4"	0.75"	(19.1)	1.50"	(38.1)	0.094"	(2.4)	1
LPA2L6L	1/8"	3/8"	0.75"	(19.1)	1.50"	(38.1)	0.094"	(2.4)	1
LPA2L8L	1/8"	1/2"	0.75"	(19.1)	1.50"	(38.1)	0.094"	(2.4)	1
LPA4L2L	1/4"	1/8"	0.63"	(16.0)	1.52"	(38.6)	0.094"	(2.4)	2
LPA4L6L	1/4"	3/8"	0.75"	(19.1)	1.65"	(41.9)	0.187"	(4.7)	2
LPA4L8L	1/4"	1/2"	1.00"	(25.4)	1.87"	(47.5)	0.187"	(4.7)	2
LPA6L2L	3/8"	1/8"	0.75"	(19.1)	1.52"	(38.6)	0.094"	(2.4)	2
LPA6L4L	3/8"	1/4"	0.75"	(19.1)	1.77"	(45.0)	0.187"	(4.7)	2
LPA6L8L	3/8"	1/2"	0.75"	(19.1)	1.84"	(46.7)	0.187"	(4.7)	2
LPA8L2L	1/2"	1/8"	0.88"	(22.4)	1.84"	(46.7)	0.093"	(2.4)	2
LPA8L4L	1/2"	1/4"	0.88"	(22.4)	1.84"	(46.7)	0.187"	(4.7)	2
LPA8L6L	1/2"	3/8"	0.88"	(22.4)	1.84"	(46.7)	0.312"	(7.9)	2

Low Pressure Male x High Pressure Female

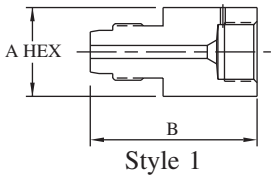

Style 1

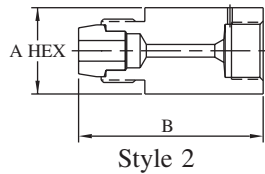

Style 2

Catalog Number	Male L/P	Female H/P	A		B		Port		Style
LPA2L4H	1/8"	1/4"	0.75"	(19.1)	1.50"	(38.1)	0.093"	(2.4)	1
LPA2L6H	1/8"	3/8"	1.00"	(25.4)	1.83"	(46.5)	0.093"	(2.4)	1
LPA2L9H	1/8"	9/16"	1.38"	(35.1)	1.87"	(47.5)	0.093"	(2.4)	1
LPA4L4H	1/4"	1/4"	0.75"	(19.1)	1.77"	(45.0)	0.093"	(2.4)	2
LPA4L6H	1/4"	3/8"	1.00"	(25.4)	1.75"	(44.5)	0.093"	(2.4)	2
LPA4L9H	1/4"	9/16"	1.38"	(35.1)	2.46"	(62.5)	0.187"	(4.7)	2
LPA6L4H	3/8"	1/4"	0.75"	(19.1)	1.65"	(41.9)	0.125"	(3.2)	2
LPA6L6H	3/8"	3/8"	1.00"	(25.4)	2.08"	(52.8)	0.125"	(3.2)	2
LPA6L9H	3/8"	9/16"	1.38"	(35.1)	2.09"	(53.1)	0.187"	(4.7)	2
LPA8L4H	1/2"	1/4"	1.38"	(35.1)	2.09"	(53.1)	0.093"	(2.4)	2
LPA8L6H	1/2"	3/8"	1.38"	(35.1)	2.09"	(53.1)	0.125"	(3.2)	2
LPA8L9H	1/2"	9/16"	1.38"	(35.1)	2.09"	(53.1)	0.250"	(6.4)	2

High Pressure Male x Low Pressure Female

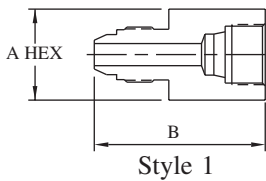

Style 1

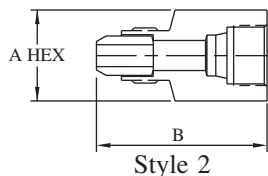

Style 2

Catalog Number	Male H/P	Female L/P	A		B		Port		Style
LPA4H2L	1/4"	1/8"	0.63"	(16.0)	1.43"	(36.3)	0.125"	(3.2)	2
LPA4H4L	1/4"	1/4"	0.75"	(19.1)	1.68"	(42.7)	0.082"	(2.1)	1
LPA4H6L	1/4"	3/8"	0.75"	(19.1)	1.68"	(42.7)	0.125"	(3.2)	2
LPA4H8L	1/4"	1/2"	0.75"	(19.1)	1.68"	(42.7)	0.125"	(3.2)	1
LPA6H2L	3/8"	1/8"	0.75"	(19.1)	1.62"	(41.1)	0.093"	(2.4)	1
LPA6H4L	3/8"	1/4"	0.75"	(19.1)	1.74"	(44.2)	0.125"	(3.2)	1
LPA6H6L	3/8"	3/8"	0.75"	(19.1)	2.00"	(50.8)	0.125"	(3.2)	1
LPA6H8L	3/8"	1/2"	0.75"	(19.1)	2.00"	(50.8)	0.218"	(5.5)	2
LPA9H2L	9/16"	1/8"	1.18"	(30.0)	2.06"	(52.3)	0.093"	(2.4)	2
LPA9H4L	9/16"	1/4"	1.18"	(30.0)	2.05"	(52.1)	0.187"	(4.7)	2
LPA9H6L	9/16"	3/8"	1.18"	(30.0)	2.06"	(52.3)	0.281"	(7.1)	2
LPA9H8L	9/16"	1/2"	1.13"	(28.7)	1.62"	(41.1)	0.281"	(7.1)	2

NOTE: See page ACC-1 to determine maximum allowable working pressure (MAWP)

All dimensions are for reference only and are subject to change.
Dimensions in parentheses are millimeters (mm).

MALE-FEMALE ADAPTERS

Low Pressure Male x Medium Pressure Female

Catalog Number	Male L/P	Female M/P	A		B		Port		Style
LPA2L4M	1/8"	1/4"	0.75"	(19.1)	1.50"	(38.1)	0.093"	(2.4)	1
LPA2L6M	1/8"	3/8"	0.75"	(19.1)	1.75"	(44.5)	0.093"	(2.4)	1
LPA2L9M	1/8"	9/16"	1.00"	(25.4)	2.00"	(50.8)	0.093"	(2.4)	1
LPA4L4M	1/4"	1/4"	0.75"	(19.1)	1.52"	(38.6)	0.125"	(3.2)	2
LPA4L6M	1/4"	3/8"	0.75"	(19.1)	1.77"	(45.0)	0.187"	(4.7)	2
LPA4L9M	1/4"	9/16"	1.00"	(25.4)	1.89"	(48.0)	0.187"	(4.7)	2
LPA4L12M	1/4"	3/4"	1.38"	(35.1)	2.27"	(57.7)	0.187"	(4.7)	2
LPA6L4M	3/8"	1/4"	0.75"	(19.1)	1.77"	(45.0)	0.109"	(2.8)	2
LPA6L6M	3/8"	3/8"	0.75"	(19.1)	2.02"	(51.3)	0.203"	(5.2)	2
LPA6L9M	3/8"	9/16"	1.00"	(25.4)	2.27"	(57.7)	0.312"	(7.9)	2
LPA6L12M	3/8"	3/4"	1.00"	(25.4)	2.31"	(58.7)	0.312"	(7.9)	2
LPA8L4M	1/2"	1/4"	0.88"	(22.4)	1.84"	(46.7)	0.109"	(2.8)	2
LPA8L6M	1/2"	3/8"	0.88"	(22.4)	2.09"	(53.1)	0.203"	(5.2)	2
LPA8L9M	1/2"	9/16"	1.00"	(25.4)	2.34"	(59.4)	0.359"	(9.1)	2
LPA8L12M	1/2"	3/4"	1.38"	(35.1)	2.34"	(59.4)	0.437"	(11.1)	2

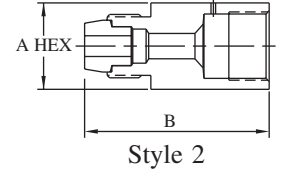
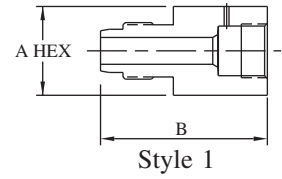

Medium Pressure Male x Low Pressure Female

Catalog Number	Male M/P	Female L/P	A		B		Port		Style
LPA4M2L	1/4"	1/8"	0.75"	(19.1)	1.50"	(38.1)	0.093"	(2.4)	1
LPA4M4L	1/4"	1/4"	0.75"	(19.1)	1.50"	(38.1)	0.109"	(2.8)	1
LPA4M6L	1/4"	3/8"	1.00"	(25.4)	1.65"	(41.9)	0.109"	(2.8)	1
LPA4M8L	1/4"	1/2"	1.00"	(25.4)	1.88"	(47.8)	0.109"	(2.8)	1
LPA6M2L	3/8"	1/8"	0.63"	(16.0)	1.25"	(31.8)	0.093"	(2.4)	2
LPA6M4L	3/8"	1/4"	0.75"	(19.1)	1.50"	(38.1)	0.187"	(4.7)	2
LPA6M6L	3/8"	3/8"	0.75"	(19.1)	1.50"	(38.1)	0.312"	(7.9)	2
LPA6M8L	3/8"	1/2"	0.75"	(19.1)	1.50"	(38.1)	0.250"	(6.4)	2
LPA9M2L	9/16"	1/8"	0.88"	(22.4)	1.50"	(38.1)	0.093"	(2.4)	2
LPA9M4L	9/16"	1/4"	0.88"	(22.4)	1.50"	(38.1)	0.187"	(4.7)	2
LPA9M6L	9/16"	3/8"	0.88"	(22.4)	1.50"	(38.1)	0.312"	(7.9)	2
LPA9M8L	9/16"	1/2"	1.00"	(25.4)	1.50"	(38.1)	0.312"	(7.9)	2
LPA12M2L	3/4"	1/8"	1.13"	(28.7)	2.00"	(50.8)	0.093"	(2.4)	2
LPA12M4L	3/4"	1/4"	1.13"	(28.7)	2.38"	(60.5)	0.187"	(4.7)	1
LPA12M6L	3/4"	3/8"	1.18"	(30.0)	1.62"	(41.1)	0.312"	(7.9)	3
LPA12M8L	3/4"	1/2"	1.38"	(35.1)	2.25"	(57.2)	0.437"	(11.1)	2
LPA16M2L	1"	1/8"	1.38"	(35.1)	2.19"	(55.6)	0.093"	(2.4)	3
LPA16M4L	1"	1/4"	1.38"	(35.1)	2.19"	(55.6)	0.187"	(4.7)	3
LPA16M6L	1"	3/8"	1.38"	(35.1)	2.25"	(57.2)	0.312"	(7.9)	2
LPA16M8L	1"	1/2"	1.38"	(35.1)	2.00"	(50.8)	0.312"	(7.9)	2

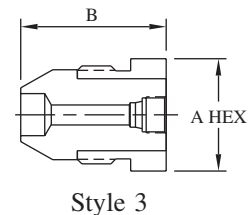
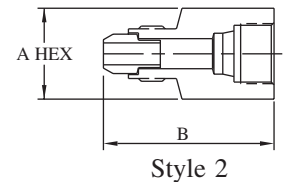
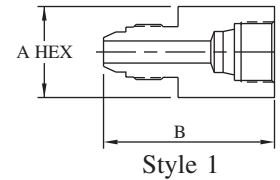

NOTE: See page ACC-1 to determine maximum allowable working pressure (MAWP)



All dimensions are for reference only and are subject to change.
Dimensions in parentheses are millimeters (mm).

MALE-FEMALE ADAPTERS

Low Pressure Male x NPT Female

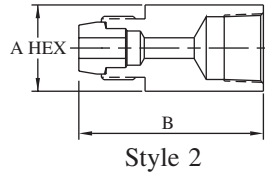
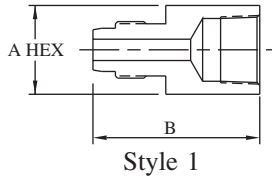

Catalog Number	Male L/P	Female NPT	A		B		Port		Style
LPA2L2P	1/8"	1/8"	0.75"	(19.1)	1.50"	(38.1)	0.093"	(2.4)	1
LPA2L4P	1/8"	1/4"	0.75"	(19.1)	1.50"	(38.1)	0.093"	(2.4)	1
LPA2L6P	1/8"	3/8"	0.75"	(19.1)	1.50"	(38.1)	0.093"	(2.4)	1
LPA2L8P	1/8"	1/2"	0.75"	(19.1)	1.50"	(38.1)	0.093"	(2.4)	1
LPA4L2P	1/4"	1/8"	0.63"	(16.0)	1.27"	(32.3)	0.187"	(4.7)	2
LPA4L4P	1/4"	1/4"	0.75"	(19.1)	1.52"	(38.6)	0.187"	(4.7)	2
LPA4L6P	1/4"	3/8"	1.00"	(25.4)	1.58"	(40.1)	0.187"	(4.7)	2
LPA4L8P	1/4"	1/2"	1.38"	(35.1)	1.89"	(48.0)	0.187"	(4.7)	2
LPA6L2P	3/8"	1/8"	0.75"	(19.1)	1.63"	(41.4)	0.125"	(3.2)	1
LPA6L4P	3/8"	1/4"	0.75"	(19.1)	1.65"	(41.9)	0.312"	(7.9)	2
LPA6L6P	3/8"	3/8"	0.75"	(19.1)	1.65"	(41.9)	0.312"	(7.9)	2
LPA6L8P	3/8"	1/2"	1.38"	(35.1)	1.89"	(48.0)	0.312"	(7.9)	2
LPA8L2P	1/2"	1/8"	1.00"	(25.4)	1.89"	(48.0)	0.437"	(11.1)	2
LPA8L4P	1/2"	1/4"	1.00"	(25.4)	1.81"	(46.0)	0.437"	(11.1)	1
LPA8L6P	1/2"	3/8"	1.00"	(25.4)	1.84"	(46.7)	0.437"	(11.1)	2
LPA8L8P	1/2"	1/2"	1.38"	(35.1)	2.09"	(53.1)	0.437"	(11.1)	2
LPA8L12P	1/2"	3/4"	1.75"	(44.5)	2.38"	(60.5)	0.437"	(11.1)	1

NPT Male x Low Pressure Female

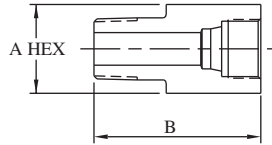

Catalog Number	Male NPT	Female L/P	A		B		Port	
LPA2P2L	1/8"	1/8"	0.50"	(12.7)	1.00"	(25.4)	0.093"	(2.4)
LPA2P4L	1/8"	1/4"	0.75"	(19.1)	1.50"	(38.1)	0.125"	(3.2)
LPA2P6L	1/8"	3/8"	0.75"	(19.1)	1.50"	(38.1)	0.125"	(3.2)
LPA2P8L	1/8"	1/2"	0.75"	(19.1)	1.50"	(38.1)	0.187"	(4.7)
LPA4P2L	1/4"	1/8"	0.75"	(19.1)	1.50"	(38.1)	0.093"	(2.4)
LPA4P4L	1/4"	1/4"	0.75"	(19.1)	1.50"	(38.1)	0.187"	(4.7)
LPA4P6L	1/4"	3/8"	0.75"	(19.1)	1.62"	(41.1)	0.187"	(4.7)
LPA4P8L	1/4"	1/2"	1.00"	(25.4)	2.00"	(50.8)	0.187"	(4.7)
LPA6P2L	3/8"	1/8"	0.75"	(19.1)	1.50"	(38.1)	0.093"	(2.4)
LPA6P4L	3/8"	1/4"	0.75"	(19.1)	1.62"	(41.1)	0.187"	(4.7)
LPA6P6L	3/8"	3/8"	0.75"	(19.1)	1.62"	(41.1)	0.250"	(6.4)
LPA6P8L	3/8"	1/2"	1.00"	(25.4)	2.00"	(50.8)	0.344"	(8.7)
LPA8P2L	1/2"	1/8"	1.00"	(25.4)	1.50"	(38.1)	0.093"	(2.4)
LPA8P4L	1/2"	1/4"	1.00"	(25.4)	1.75"	(44.5)	0.187"	(4.7)
LPA8P6L	1/2"	3/8"	1.00"	(25.4)	1.75"	(44.5)	0.312"	(7.9)
LPA8P8L	1/2"	1/2"	1.00"	(25.4)	2.00"	(50.8)	0.437"	(11.1)
LPA12P8L	3/4"	1/2"	1.38"	(35.1)	2.25"	(57.2)	0.437"	(11.1)
LPA16P6L	1"	3/8"	1.38"	(35.1)	2.00"	(50.8)	0.312"	(7.9)
LPA16P8L	1"	1/2"	1.38"	(35.1)	2.25"	(57.2)	0.312"	(7.9)

NOTE: See page ACC-1 to determine maximum allowable working pressure (MAWP)

All dimensions are for reference only and are subject to change.
Dimensions in parentheses are millimeters (mm).

MALE-FEMALE ADAPTERS

NPT Male x Medium Pressure Female

Catalog Number	Male NPT	Female M/P	A		B		Port
10A2P4M	1/8"	1/4"	0.75"	(19.1)	1.50"	(38.1)	0.109" (2.8)
10A2P6M	1/8"	3/8"	0.75"	(19.1)	1.75"	(44.5)	0.203" (5.2)
10A2P9M	1/8"	9/16"	1.00"	(25.4)	2.00"	(50.8)	0.218" (5.5)
10A4P4M	1/4"	1/4"	0.75"	(19.1)	1.50"	(38.1)	0.109" (2.8)
10A4P6M	1/4"	3/8"	0.75"	(19.1)	1.75"	(44.5)	0.203" (5.2)
10A4P9M	1/4"	9/16"	1.00"	(25.4)	2.00"	(50.8)	0.250" (6.4)
10A4P12M	1/4"	3/4"	1.38"	(35.1)	2.50"	(63.5)	0.250" (6.4)
10A6P4M	3/8"	1/4"	0.75"	(19.1)	1.50"	(38.1)	0.109" (2.8)
10A6P6M	3/8"	3/8"	0.75"	(19.1)	1.75"	(44.5)	0.203" (5.2)
10A6P9M	3/8"	9/16"	1.00"	(25.4)	2.00"	(50.8)	0.359" (9.1)
10A6P12M	3/8"	3/4"	1.38"	(35.1)	2.50"	(63.5)	0.375" (9.5)
10A8P4M	1/2"	1/4"	1.00"	(25.4)	1.50"	(38.1)	0.125" (3.2)
10A8P6M	1/2"	3/8"	1.00"	(25.4)	1.75"	(44.5)	0.203" (5.2)
10A8P9M	1/2"	9/16"	1.00"	(25.4)	2.00"	(50.8)	0.359" (9.1)
10A8P12M	1/2"	3/4"	1.38"	(35.1)	2.50"	(63.5)	0.516" (13.1)
10A8P16M	1/2"	1"	1.75"	(44.5)	3.00"	(76.2)	0.437" (11.1)
10A12P4M	3/4"	1/4"	1.38"	(35.1)	2.12"	(53.8)	0.187" (4.7)
10A12P6M	3/4"	3/8"	1.38"	(35.1)	2.25"	(57.2)	0.203" (5.2)
10A12P9M	3/4"	9/16"	1.38"	(35.1)	2.25"	(57.2)	0.359" (9.1)
10A12P12M	3/4"	3/4"	1.38"	(35.1)	2.50"	(63.5)	0.500" (12.7)
10A12P16M	3/4"	1"	1.75"	(44.5)	3.00"	(76.2)	0.500" (12.7)
10A16P9M	1"	9/16"	1.38"	(35.1)	2.25"	(57.2)	0.359" (9.1)
10A16P12M	1"	3/4"	1.38"	(35.1)	2.50"	(63.5)	0.359" (9.1)
10A16P16M	1"	1"	1.75"	(44.5)	3.00"	(76.2)	0.563" (14.3)

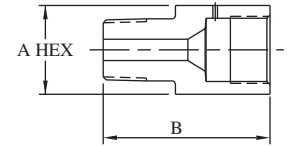

NPT Male x High Pressure Female

Catalog Number	Male NPT	Female H/P	A		B		Port
10A2P4H	1/8"	1/4"	0.75"	(19.1)	1.50"	(38.1)	0.093" (2.4)
10A2P6H	1/8"	3/8"	1.00"	(25.4)	1.75"	(44.5)	0.125" (3.2)
10A2P9H	1/8"	9/16"	1.38"	(35.1)	2.25"	(57.2)	0.187" (4.7)
10A4P4H	1/4"	1/4"	0.75"	(19.1)	1.50"	(38.1)	0.093" (2.4)
10A4P6H	1/4"	3/8"	1.00"	(25.4)	1.75"	(44.5)	0.125" (3.2)
10A4P9H	1/4"	9/16"	1.38"	(35.1)	2.25"	(57.2)	0.187" (4.7)
10A6P4H	3/8"	1/4"	0.75"	(19.1)	1.50"	(38.1)	0.093" (2.4)
10A6P6H	3/8"	3/8"	1.00"	(25.4)	1.75"	(44.5)	0.125" (3.2)
10A6P9H	3/8"	9/16"	1.38"	(35.1)	2.25"	(57.2)	0.187" (4.7)
10A8P4H	1/2"	1/4"	1.00"	(25.4)	1.62"	(41.1)	0.093" (2.4)
10A8P6H	1/2"	3/8"	1.00"	(25.4)	1.75"	(44.5)	0.125" (3.2)
10A8P9H	1/2"	9/16"	1.38"	(35.1)	2.25"	(57.2)	0.187" (4.7)
10A12P4H	3/4"	1/4"	1.13"	(28.7)	2.00"	(50.8)	0.093" (2.4)
10A12P6H	3/4"	3/8"	1.13"	(28.7)	2.00"	(50.8)	0.125" (3.2)
10A12P9H	3/4"	9/16"	1.38"	(35.1)	2.25"	(57.2)	0.187" (4.7)
10A16P4H	1"	1/4"	1.38"	(35.1)	1.75"	(44.5)	0.093" (2.4)
10A16P6H	1"	3/8"	1.38"	(35.1)	2.00"	(50.8)	0.125" (3.2)
10A16P9H	1"	9/16"	1.38"	(35.1)	2.25"	(57.2)	0.187" (4.7)

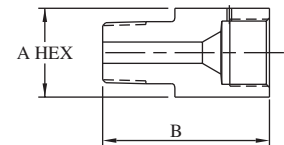

NOTE: See page ACC-1 to determine maximum allowable working pressure (MAWP)



All dimensions are for reference only and are subject to change.
Dimensions in parentheses are millimeters (mm).

MALE-FEMALE ADAPTERS

Medium Pressure Male x NPT Female

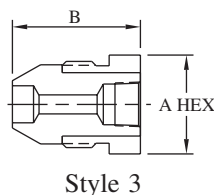
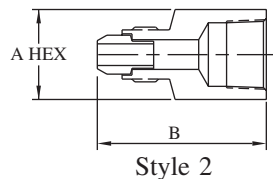
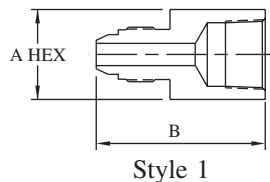

Catalog Number	Male M/P	Female NPT	A		B		Port		Style
10A4M2P	1/4"	1/8"	0.63"	(16.0)	1.56"	(39.6)	0.109"	(2.8)	1
10A4M4P	1/4"	1/4"	0.75"	(19.1)	1.63"	(41.4)	0.109"	(2.8)	1
10A4M6P	1/4"	3/8"	1.00"	(25.4)	2.00"	(50.8)	0.109"	(2.8)	1
10A4M8P	1/4"	1/2"	1.38"	(35.1)	2.19"	(55.6)	0.109"	(2.8)	1
10A6M2P	3/8"	1/8"	0.63"	(16.0)	1.62"	(41.1)	0.125"	(3.2)	2
10A6M4P	3/8"	1/4"	0.75"	(19.1)	1.88"	(47.8)	0.250"	(6.4)	2
10A6M6P	3/8"	3/8"	1.00"	(25.4)	1.88"	(47.8)	0.250"	(6.4)	2
10A6M8P	3/8"	1/2"	1.38"	(35.1)	2.13"	(54.1)	0.250"	(6.4)	2
10A9M2P	9/16"	1/8"	0.88"	(22.4)	1.88"	(47.8)	0.339"	(8.6)	2
10A9M4P	9/16"	1/4"	0.88"	(22.4)	1.88"	(47.8)	0.406"	(10.3)	2
10A9M6P	9/16"	3/8"	1.00"	(25.4)	2.38"	(60.5)	0.406"	(10.3)	2
10A9M8P	9/16"	1/2"	1.00"	(25.4)	2.38"	(60.5)	0.406"	(10.3)	2
10A9M12P	9/16"	3/4"	1.75"	(44.5)	2.62"	(66.5)	0.406"	(10.3)	2
10A9M16P	9/16"	1"	1.75"	(44.5)	2.62"	(66.5)	0.406"	(10.3)	2
10A12M2P	3/4"	1/8"	1.13"	(28.7)	2.40"	(61.0)	0.250"	(6.4)	2
10A12M4P	3/4"	1/4"	1.13"	(28.7)	2.40"	(61.0)	0.250"	(6.4)	2
10A12M6P	3/4"	3/8"	1.13"	(28.7)	2.62"	(66.5)	0.563"	(14.3)	2
10A12M8P	3/4"	1/2"	1.38"	(35.1)	2.62"	(66.5)	0.563"	(14.3)	2
10A12M12P	3/4"	3/4"	1.75"	(44.5)	2.90"	(73.7)	0.437"	(11.1)	2
10A12M16P	3/4"	1"	2.13"	(54.1)	2.62"	(66.5)	0.563"	(14.3)	2
10A16M2P	1"	1/8"	1.38"	(35.1)	2.62"	(66.5)	0.250"	(6.4)	2
10A16M4P	1"	1/4"	1.38"	(35.1)	2.62"	(66.5)	0.250"	(6.4)	1
10A16M6P	1"	3/8"	1.38"	(35.1)	2.19"	(55.6)	0.563"	(14.3)	3
10A16M8P	1"	1/2"	1.38"	(35.1)	2.80"	(71.1)	0.703"	(17.9)	2
10A16M12P	1"	3/4"	1.75"	(44.5)	2.80"	(71.1)	0.718"	(18.2)	2
10A16M16P	1"	1"	2.13"	(54.1)	3.30"	(83.8)	0.718"	(18.2)	2

High Pressure Male x NPT Female

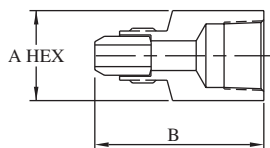

Catalog Number	Male H/P	Female NPT	A		B		Port	
10A4H2P	1/4"	1/8"	0.63"	(16.0)	1.43"	(36.3)	0.125"	(3.2)
10A4H4P	1/4"	1/4"	0.75"	(19.1)	1.68"	(42.7)	0.125"	(3.2)
10A4H6P	1/4"	3/8"	1.00"	(25.4)	1.68"	(42.7)	0.125"	(3.2)
10A4H8P	1/4"	1/2"	1.38"	(35.1)	1.93"	(49.0)	0.125"	(3.2)
10A6H2P	3/8"	1/8"	0.75"	(19.1)	1.75"	(44.5)	0.218"	(5.5)
10A6H4P	3/8"	1/4"	1.00"	(25.4)	2.00"	(50.8)	0.218"	(5.5)
10A6H6P	3/8"	3/8"	1.00"	(25.4)	2.00"	(50.8)	0.218"	(5.5)
10A6H8P	3/8"	1/2"	1.38"	(35.1)	2.38"	(60.5)	0.218"	(5.5)
10A9H2P	9/16"	1/8"	1.18"	(30.0)	2.06"	(52.3)	0.281"	(7.1)
10A9H4P	9/16"	1/4"	1.18"	(30.0)	2.06"	(52.3)	0.281"	(7.1)
10A9H6P	9/16"	3/8"	1.18"	(30.0)	2.06"	(52.3)	0.281"	(7.1)
10A9H8P	9/16"	1/2"	1.38"	(35.1)	2.06"	(52.3)	0.281"	(7.1)
10A9H12P	9/16"	3/4"	1.75"	(44.5)	2.69"	(68.3)	0.281"	(7.1)
10A9H16P	9/16"	1"	2.13"	(54.1)	2.93"	(74.4)	0.281"	(7.1)

NOTE: See page ACC-1 to determine maximum allowable working pressure (MAWP)

All dimensions are for reference only and are subject to change.
Dimensions in parentheses are millimeters (mm).

MALE-FEMALE ADAPTERS

Medium Pressure Male x Medium Pressure Female

Catalog Number	Male M/P	Female M/P	A		B		Port	Style	
20A4M6M	1/4"	3/8"	0.75"	(19.1)	1.75"	(44.5)	0.109"	(2.8)	1
20A4M9M	1/4"	9/16"	1.00"	(25.4)	2.00"	(50.8)	0.109"	(2.8)	1
20A4M12M	1/4"	3/4"	1.38"	(35.1)	2.50"	(63.5)	0.109"	(2.8)	1
20A4M16M	1/4"	1"	1.75"	(44.5)	3.00"	(76.2)	0.109"	(2.8)	1
20A6M4M	3/8"	1/4"	0.75"	(19.1)	1.88"	(47.8)	0.109"	(2.8)	2
20A6M9M	3/8"	9/16"	1.00"	(25.4)	2.38"	(60.5)	0.250"	(6.4)	2
20A6M12M	3/8"	3/4"	1.38"	(35.1)	2.55"	(64.8)	0.125"	(3.2)	2
20A6M16M	3/8"	1"	1.75"	(44.5)	3.13"	(79.5)	0.250"	(6.4)	2
20A9M4M	9/16"	1/4"	0.88"	(22.4)	1.88"	(47.8)	0.109"	(2.8)	2
20A9M6M	9/16"	3/8"	0.88"	(22.4)	1.88"	(47.8)	0.203"	(5.2)	2
20A9M12M	9/16"	3/4"	1.38"	(35.1)	2.88"	(73.2)	0.312"	(7.9)	2
20A9M16M	9/16"	1"	1.75"	(44.5)	3.38"	(85.9)	0.312"	(7.9)	2
20A12M4M	3/4"	1/4"	1.18"	(30.0)	1.62"	(41.1)	0.125"	(3.2)	3
20A12M6M	3/4"	3/8"	1.18"	(30.0)	1.62"	(41.1)	0.203"	(5.2)	3
20A12M9M	3/4"	9/16"	1.13"	(28.7)	1.69"	(42.9)	0.359"	(9.1)	4
20A12M12M	3/4"	3/4"	1.38"	(35.1)	2.65"	(67.3)	0.438"	(11.1)	2
20A12M16M	3/4"	1"	1.75"	(44.5)	3.40"	(86.4)	0.437"	(11.1)	2
20A16M4M	1"	1/4"	1.38"	(35.1)	2.19"	(55.6)	0.125"	(3.2)	3
20A16M6M	1"	3/8"	1.38"	(35.1)	2.19"	(55.6)	0.203"	(5.2)	3
20A16M9M	1"	9/16"	1.38"	(35.1)	2.19"	(55.6)	0.359"	(9.1)	3
20A16M12M	1"	3/4"	1.38"	(35.1)	3.05"	(77.5)	0.516"	(13.1)	2
20A16M16M	1"	1"	1.75"	(44.5)	3.55"	(90.2)	0.563"	(14.3)	2

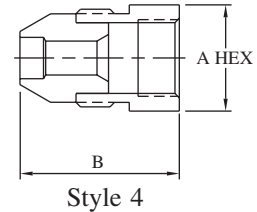
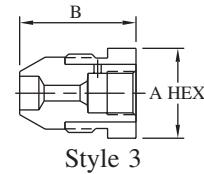
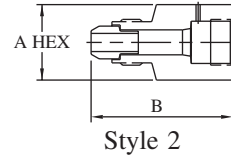
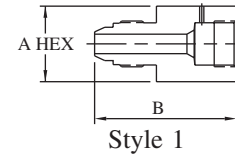

Medium Pressure Male x High Pressure Female

Catalog Number	Male M/P	Female H/P	A		B		Port	Style	
20A4M4H	1/4"	1/4"	0.75"	(19.1)	1.50"	(38.1)	0.109"	(2.8)	1
20A4M6H	1/4"	3/8"	1.00"	(25.4)	1.75"	(44.5)	0.125"	(3.2)	1
20A4M9H	1/4"	9/16"	1.00"	(25.4)	1.75"	(44.5)	0.140"	(3.6)	1
20A6M4H	3/8"	1/4"	0.75"	(19.1)	1.88"	(47.8)	0.093"	(2.4)	2
20A6M6H	3/8"	3/8"	1.00"	(25.4)	2.13"	(54.1)	0.125"	(3.2)	2
20A6M9H	3/8"	9/16"	1.38"	(35.1)	2.50"	(63.5)	0.188"	(4.8)	2
20A9M4H	9/16"	1/4"	0.88"	(22.4)	1.88"	(47.8)	0.188"	(4.8)	2
20A9M6H	9/16"	3/8"	1.00"	(25.4)	2.13"	(54.1)	0.125"	(3.2)	2
20A9M9H	9/16"	9/16"	1.38"	(35.1)	2.63"	(66.8)	0.187"	(4.7)	2
20A12M4H	3/4"	1/4"	1.18"	(30.0)	1.62"	(41.1)	0.093"	(2.4)	3
20A12M6H	3/4"	3/8"	1.13"	(28.7)	2.40"	(61.0)	0.125"	(3.2)	2
20A12M9H	3/4"	9/16"	1.38"	(35.1)	2.65"	(67.3)	0.187"	(4.7)	2
20A16M4H	1"	1/4"	1.38"	(35.1)	2.19"	(55.6)	0.093"	(2.4)	3
20A16M6H	1"	3/8"	1.38"	(35.1)	2.19"	(55.6)	0.125"	(3.2)	2
20A16M9H	1"	9/16"	1.38"	(35.1)	2.80"	(71.1)	0.188"	(4.8)	2

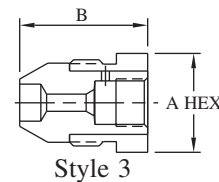
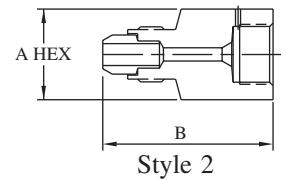
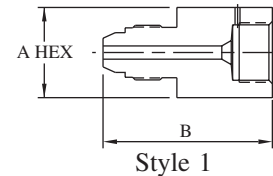

NOTE: See page ACC-1 to determine maximum allowable working pressure (MAWP)



All dimensions are for reference only and are subject to change.
Dimensions in parentheses are millimeters (mm).

Page ACC-7



MALE-FEMALE ADAPTERS

High Pressure Male x Medium Pressure Female

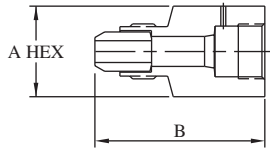

Catalog Number	Male H/P	Female M/P	A		B		Port	
20A4H4M	1/4"	1/4"	0.75"	(19.1)	1.68"	(42.7)	0.109"	(2.8)
20A4H6M	1/4"	3/8"	0.75"	(19.1)	1.93"	(49.0)	0.125"	(3.2)
20A4H9M	1/4"	9/16"	1.00"	(25.4)	2.18"	(55.4)	0.125"	(3.2)
20A4H12M	1/4"	3/4"	1.38"	(35.1)	2.68"	(68.1)	0.125"	(3.2)
20A4H16M	1/4"	1"	1.75"	(44.5)	2.75"	(69.9)	0.125"	(3.2)
20A6H4M	3/8"	1/4"	0.75"	(19.1)	1.75"	(44.5)	0.109"	(2.8)
20A6H6M	3/8"	3/8"	0.75"	(19.1)	2.00"	(50.8)	0.203"	(5.2)
20A6H9M	3/8"	9/16"	1.00"	(25.4)	2.25"	(57.2)	0.218"	(5.5)
20A6H12M	3/8"	3/4"	1.38"	(35.1)	2.75"	(69.9)	0.218"	(5.5)
20A6H16M	3/8"	1"	1.75"	(44.5)	3.25"	(82.6)	0.218"	(5.5)
20A9H4M	9/16"	1/4"	1.18"	(30.0)	2.06"	(52.3)	0.125"	(3.2)
20A9H6M	9/16"	3/8"	1.18"	(30.0)	2.06"	(52.3)	0.203"	(5.2)
20A9H9M	9/16"	9/16"	1.18"	(30.0)	2.06"	(52.3)	0.281"	(7.1)
20A9H12M	9/16"	3/4"	1.37"	(34.8)	2.81"	(71.4)	0.281"	(7.1)
20A9H16M	9/16"	1"	1.75"	(44.5)	3.31"	(84.1)	0.281"	(7.1)

High Pressure Male x High Pressure Female

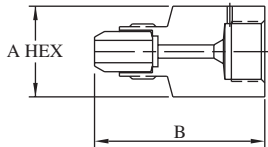

Catalog Number	Male H/P	Female H/P	A		B		Port	
60A4H4H	1/4"	1/4"	0.75"	(19.1)	1.43"	(36.3)	0.093"	(2.4)
60A4H6H	1/4"	3/8"	1.00"	(25.4)	1.93"	(49.0)	0.125"	(3.2)
60A4H9H	1/4"	9/16"	1.38"	(35.1)	2.43"	(61.7)	0.125"	(3.2)
60A6H4H	3/8"	1/4"	0.75"	(19.1)	1.75"	(44.5)	0.093"	(2.4)
60A6H9H	3/8"	9/16"	1.38"	(35.1)	2.00"	(50.8)	0.188"	(4.8)
60A9H4H	9/16"	1/4"	1.18"	(30.0)	1.75"	(44.5)	0.093"	(2.4)
60A9H6H	9/16"	3/8"	1.18"	(30.0)	1.87"	(47.5)	0.125"	(3.2)
60A9H9H	9/16"	9/16"	1.38"	(35.1)	2.56"	(65.0)	0.188"	(4.8)

NOTE: See page ACC-1 to determine maximum allowable working pressure (MAWP)

All dimensions are for reference only and are subject to change.
Dimensions in parentheses are millimeters (mm).

MALE-MALE ADAPTERS

Medium Pressure Male x NPT Male

Catalog Number	Male M/P	Male NPT	A		B		Port	Style	
MA4M2P	1/4"	1/8"	0.88"	(22.4)	2.25"	(57.2)	0.109"	(2.8)	1
MA4M4P	1/4"	1/4"	0.88"	(22.4)	2.25"	(57.2)	0.109"	(2.8)	1
MA4M6P	1/4"	3/8"	0.88"	(22.4)	2.25"	(57.2)	0.109"	(2.8)	1
MA4M8P	1/4"	1/2"	1.00"	(25.4)	2.50"	(63.5)	0.109"	(2.8)	1
MA4M12P	1/4"	3/4"	1.38"	(35.1)	2.38"	(60.5)	0.109"	(2.8)	1
MA6M2P	3/8"	1/8"	0.75"	(19.1)	2.12"	(53.8)	0.187"	(4.7)	2
MA6M4P	3/8"	1/4"	0.75"	(19.1)	2.37"	(60.2)	0.250"	(6.4)	2
MA6M6P	3/8"	3/8"	0.75"	(19.1)	2.37"	(60.2)	0.250"	(6.4)	2
MA6M8P	3/8"	1/2"	1.00"	(25.4)	2.50"	(63.5)	0.198"	(5.0)	1
MA6M12P	3/8"	3/4"	1.38"	(35.1)	2.37"	(60.2)	0.250"	(6.4)	2
MA9M2P	9/16"	1/8"	1.00"	(25.4)	2.50"	(63.5)	0.281"	(7.1)	2
MA9M4P	9/16"	1/4"	0.88"	(22.4)	2.63"	(66.8)	0.250"	(6.4)	2
MA9M6P	9/16"	3/8"	1.00"	(25.4)	2.38"	(60.5)	0.375"	(9.5)	2
MA9M8P	9/16"	1/2"	0.88"	(22.4)	2.63"	(66.8)	0.359"	(9.1)	2
MA9M12P	9/16"	3/4"	1.13"	(28.7)	2.88"	(73.2)	0.359"	(9.1)	2
MA9M16P	9/16"	1"	1.38"	(35.1)	2.82"	(71.6)	0.406"	(10.3)	2
MA12M2P	3/4"	1/8"	1.38"	(35.1)	2.75"	(69.9)	0.562"	(14.3)	2
MA12M4P	3/4"	1/4"	1.13"	(28.7)	2.75"	(69.9)	0.250"	(6.4)	1
MA12M6P	3/4"	3/8"	1.13"	(28.7)	3.15"	(80.0)	0.375"	(9.5)	2
MA12M8P	3/4"	1/2"	1.13"	(28.7)	3.40"	(86.4)	0.375"	(9.5)	2
MA12M12P	3/4"	3/4"	1.75"	(44.5)	3.40"	(86.4)	0.250"	(6.4)	2
MA16P12M	3/4"	1"	1.38"	(35.1)	3.29"	(83.6)	0.562"	(14.3)	2
MA16M2P	1"	1/8"	1.38"	(35.1)	3.00"	(76.2)	0.718"	(18.2)	2
MA16M4P	1"	1/4"	1.38"	(35.1)	3.00"	(76.2)	0.250"	(6.4)	1
MA16M6P	1"	3/8"	1.50"	(38.1)	2.50"	(63.5)	0.375"	(9.5)	2
MA16M8P	1"	1/2"	1.38"	(35.1)	3.30"	(83.8)	0.437"	(11.1)	2
MA16M12P	1"	3/4"	1.38"	(35.1)	3.38"	(85.9)	0.500"	(12.7)	1
MA16M16P	1"	1"	1.38"	(35.1)	3.67"	(93.2)	0.562"	(14.3)	2

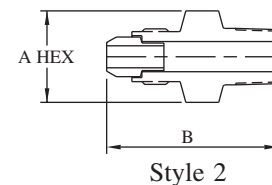
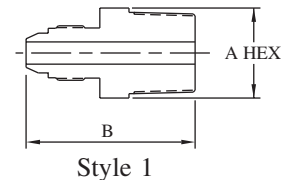

Medium Pressure Male x Medium Pressure Male

Catalog Number	Male M/P	Male M/P	A		B		Port	Style	
MA4M4M	1/4"	1/4"	0.88"	(22.4)	2.25"	(57.2)	0.109"	(2.8)	1
MA4M6M	1/4"	3/8"	0.88"	(22.4)	2.63"	(66.8)	0.109"	(2.8)	3
MA4M9M	1/4"	9/16"	0.88"	(22.4)	2.63"	(66.8)	0.109"	(2.8)	3
MA4M12M	1/4"	3/4"	1.13"	(28.7)	2.75"	(69.9)	0.109"	(2.8)	1
MA6M6M	3/8"	3/8"	0.75"	(19.1)	2.75"	(69.9)	0.250"	(6.4)	2
MA6M16M	3/8"	1"	1.38"	(35.1)	3.15"	(80.0)	0.250"	(6.4)	2
MA9M6M	9/16"	3/8"	1.00"	(25.4)	2.75"	(69.9)	0.250"	(6.4)	2
MA9M9M	9/16"	9/16"	0.88"	(22.4)	3.00"	(76.2)	0.312"	(7.9)	2
MA9M12M	9/16"	3/4"	1.13"	(28.7)	2.86"	(72.6)	0.406"	(10.3)	2
MA9M16M	9/16"	1"	1.38"	(35.1)	3.25"	(82.6)	0.500"	(12.7)	1
MA12M6M	3/4"	3/8"	1.13"	(28.7)	2.74"	(69.6)	0.250"	(6.4)	2
MA12M12M	3/4"	3/4"	1.13"	(28.7)	3.55"	(90.2)	0.516"	(13.1)	2
MA12M16M	3/4"	1"	1.38"	(35.1)	3.50"	(88.9)	0.500"	(12.7)	1
MA16M4M	1"	1/4"	1.38"	(35.1)	3.30"	(83.8)	0.562"	(14.3)	2
MA16M16M	1"	1"	1.38"	(35.1)	4.10"	(104.1)	0.688"	(17.5)	2

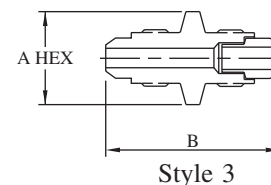
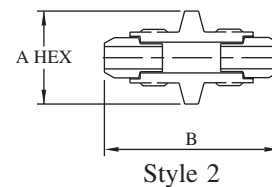
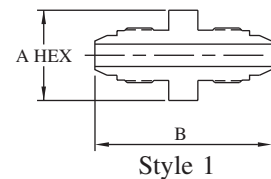

NOTE: See page ACC-1 to determine maximum allowable working pressure (MAWP)



All dimensions are for reference only and are subject to change.
Dimensions in parentheses are millimeters (mm).

MALE-MALE ADAPTERS

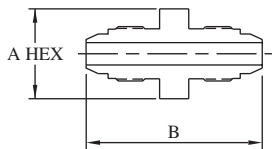

Style 1

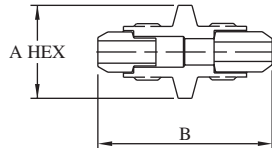

Style 2

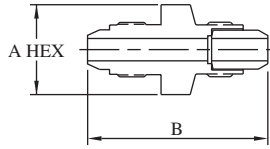

Style 3

Medium Pressure Male x High Pressure Male

Catalog Number	Male M/P	Male H/P	A	B	Port	Style
MA4M4H	1/4"	1/4"	0.88" (22.4)	2.43" (61.7)	0.109" (2.8)	3
MA4M6H	1/4"	3/8"	0.75" (19.1)	2.46" (62.5)	0.109" (2.8)	1
MA4M9H	1/4"	9/16"	1.13" (28.7)	2.50" (63.5)	0.109" (2.8)	3
MA6M4H	3/8"	1/4"	0.75" (19.1)	2.56" (65.0)	0.125" (3.2)	2
MA6M6H	3/8"	3/8"	1.00" (25.4)	2.45" (62.2)	0.250" (6.4)	2
MA6M9H	3/8"	9/16"	1.13" (28.7)	2.99" (75.9)	0.250" (6.4)	2
MA9M4H	9/16"	1/4"	1.00" (25.4)	2.56" (65.0)	0.125" (3.2)	2
MA9M6H	9/16"	3/8"	1.00" (25.4)	2.62" (66.5)	0.218" (5.5)	2
MA9M9H	9/16"	9/16"	1.13" (28.7)	3.18" (80.8)	0.281" (7.1)	2
MA12M4H	3/4"	1/4"	1.38" (35.1)	3.00" (76.2)	0.125" (3.2)	1
MA6H12M	3/4"	3/8"	1.38" (35.1)	2.81" (71.4)	0.125" (3.2)	1
MA12M9H	3/4"	9/16"	1.38" (35.1)	3.00" (76.2)	0.281" (7.1)	2
MA16M4H	1"	1/4"	1.38" (35.1)	3.11" (79.0)	0.125" (3.2)	2
MA16M6H	1"	3/8"	1.38" (35.1)	3.50" (88.9)	0.218" (5.5)	2
MA16M9H	1"	9/16"	1.38" (35.1)	3.61" (91.7)	0.281" (7.1)	2

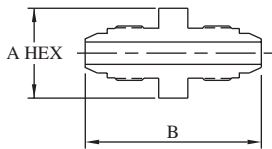

Style 1

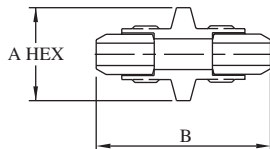

Style 2

High Pressure Male x High Pressure Male

Catalog Number	Male H/P	Male H/P	A	B	Port	Style
MA4H4H	1/4"	1/4"	0.75" (19.1)	2.12" (53.8)	0.125" (3.2)	2
MA6H4H	3/8"	1/4"	0.75" (19.1)	2.42" (61.5)	0.082" (2.1)	1
MA6H6H	3/8"	3/8"	0.75" (19.1)	2.50" (63.5)	0.218" (5.5)	2
MA9H4H	9/16"	1/4"	1.13" (28.7)	2.99" (75.9)	0.125" (3.2)	2
MA9H6H	9/16"	3/8"	1.18" (30.0)	3.06" (77.7)	0.218" (5.5)	2
MA9H9H	9/16"	9/16"	1.18" (30.0)	3.37" (85.6)	0.218" (5.5)	2

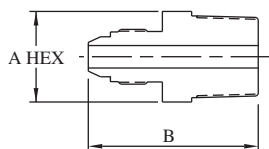

Style 1

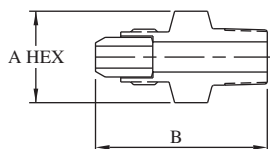

Style 2

High Pressure Male x NPT Male

Catalog Number	Male H/P	Male NPT	A	B	Port	Style
MA4H2P	1/4"	1/8"	1.00" (25.4)	2.18" (55.4)	0.125" (3.2)	1
MA4H4P	1/4"	1/4"	1.00" (25.4)	2.18" (55.4)	0.125" (3.2)	2
MA4H6P	1/4"	3/8"	0.75" (19.1)	1.86" (47.2)	0.125" (3.2)	2
MA4H8P	1/4"	1/2"	1.00" (25.4)	2.18" (55.4)	0.125" (3.2)	2
MA4H12P	1/4"	3/4"	1.38" (35.1)	2.18" (55.4)	0.125" (3.2)	2
MA4H16P	1/4"	1"	1.38" (35.1)	2.68" (68.1)	0.125" (3.2)	2
MA6H2P	3/8"	1/8"	1.00" (25.4)	2.75" (69.9)	0.188" (4.8)	2
MA6H4P	3/8"	1/4"	1.00" (25.4)	2.75" (69.9)	0.218" (5.5)	2
MA6H6P	3/8"	3/8"	0.81" (20.6)	2.19" (55.6)	0.218" (5.5)	2
MA6H8P	3/8"	1/2"	1.00" (25.4)	3.00" (76.2)	0.125" (3.2)	1
MA6H12P	3/8"	3/4"	1.13" (28.7)	3.00" (76.2)	0.218" (5.5)	2
MA6H16P	3/8"	1"	1.13" (28.7)	3.00" (76.2)	0.218" (5.5)	2
MA9H2P	9/16"	1/8"	1.13" (28.7)	3.00" (76.2)	0.188" (4.8)	2
MA9H4P	9/16"	1/4"	1.13" (28.7)	2.81" (71.4)	0.250" (6.4)	2
MA9H6P	9/16"	3/8"	1.13" (28.7)	2.81" (71.4)	0.281" (7.1)	2
MA9H8P	9/16"	1/2"	1.18" (30.0)	3.00" (76.2)	0.281" (7.1)	2
MA9H12P	9/16"	3/4"	1.13" (28.7)	2.63" (66.8)	0.281" (7.1)	2
MA9H16P	9/16"	1"	1.38" (35.1)	3.00" (76.2)	0.281" (7.1)	2

NOTE: See page ACC-1 to determine maximum allowable working pressure (MAWP)

All dimensions are for reference only and are subject to change.
Dimensions in parentheses are millimeters (mm).

FEMALE-FEMALE COUPLINGS

Low Pressure Female x Low Pressure Female

Catalog Number	Female L/P	Female L/P	A		B		Port	
LPC2L4L	1/8"	1/4"	0.75"	(19.1)	1.50"	(38.1)	0.093"	(2.4)
LPC2L6L	1/8"	3/8"	0.75"	(19.1)	1.75"	(44.5)	0.093"	(2.4)
LPC2L8L	1/8"	1/2"	1.00"	(25.4)	2.00"	(50.8)	0.093"	(2.4)
LPC4L6L	1/4"	3/8"	0.75"	(19.1)	1.75"	(44.5)	0.187"	(4.7)
LPC4L8L	1/4"	1/2"	1.00"	(25.4)	2.00"	(50.8)	0.187"	(4.7)
LPC6L8L	3/8"	1/2"	1.00"	(25.4)	2.00"	(50.8)	0.312"	(7.9)

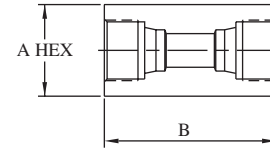

Low Pressure Female x High Pressure Female

Catalog Number	Female L/P	Female H/P	A		B		Port	
LPC2L4H	1/8"	1/4"	0.75"	(19.1)	1.50"	(38.1)	0.093"	(2.4)
LPC2L6H	1/8"	3/8"	1.00"	(25.4)	2.00"	(50.8)	0.093"	(2.4)
LPC2L9H	1/8"	9/16"	1.38"	(35.1)	2.25"	(57.2)	0.093"	(2.4)
LPC4L4H	1/4"	1/4"	0.75"	(19.1)	1.50"	(38.1)	0.093"	(2.4)
LPC4L6H	1/4"	3/8"	1.00"	(25.4)	1.75"	(44.5)	0.125"	(3.2)
LPC4L9H	1/4"	9/16"	1.38"	(35.1)	2.25"	(57.2)	0.187"	(4.7)
LPC6L4H	3/8"	1/4"	0.75"	(19.1)	1.50"	(38.1)	0.093"	(2.4)
LPC6L6H	3/8"	3/8"	1.00"	(25.4)	1.75"	(44.5)	0.125"	(3.2)
LPC6L9H	3/8"	9/16"	1.38"	(35.1)	2.25"	(57.2)	0.187"	(4.7)
LPC8L4H	1/2"	1/4"	1.00"	(25.4)	1.62"	(41.1)	0.093"	(2.4)
LPC8L6H	1/2"	3/8"	1.38"	(35.1)	2.00"	(50.8)	0.125"	(3.2)
LPC8L9H	1/2"	9/16"	1.38"	(35.1)	2.25"	(57.2)	0.187"	(4.7)

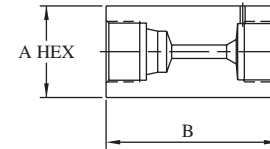

Low Pressure Female x Medium Pressure Female

Catalog Number	Female L/P	Female M/P	A		B		Port	
LPC2L4M	1/8"	1/4"	0.75"	(19.1)	1.50"	(38.1)	0.093"	(2.4)
LPC2L6M	1/8"	3/8"	1.00"	(25.4)	1.50"	(38.1)	0.093"	(2.4)
LPC2L9M	1/8"	9/16"	1.00"	(25.4)	2.00"	(50.8)	0.093"	(2.4)
LPC4L4M	1/4"	1/4"	0.75"	(19.1)	1.50"	(38.1)	0.103"	(2.6)
LPC4L6M	1/4"	3/8"	0.75"	(19.1)	1.75"	(44.5)	0.203"	(5.2)
LPC4L9M	1/4"	9/16"	1.00"	(25.4)	2.00"	(50.8)	0.187"	(4.7)
LPC6L4M	3/8"	1/4"	0.75"	(19.1)	1.50"	(38.1)	0.103"	(2.6)
LPC6L6M	3/8"	3/8"	0.75"	(19.1)	1.75"	(44.5)	0.203"	(5.2)
LPC6L9M	3/8"	9/16"	1.00"	(25.4)	2.00"	(50.8)	0.312"	(7.9)
LPC6L12M	3/8"	3/4"	1.38"	(35.1)	2.50"	(63.5)	0.312"	(7.9)
LPC8L4M	1/2"	1/4"	0.75"	(19.1)	2.00"	(50.8)	0.103"	(2.6)
LPC8L6M	1/2"	3/8"	1.00"	(25.4)	2.00"	(50.8)	0.203"	(5.2)
LPC8L9M	1/2"	9/16"	1.00"	(25.4)	2.00"	(50.8)	0.359"	(9.1)
LPC8L12M	1/2"	3/4"	1.38"	(35.1)	2.50"	(63.5)	0.437"	(11.1)

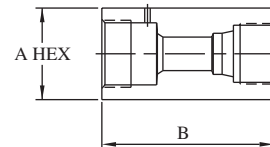

NOTE: See page ACC-1 to determine maximum allowable working pressure (MAWP)



All dimensions are for reference only and are subject to change.
Dimensions in parentheses are millimeters (mm).

FEMALE-FEMALE COUPLINGS

Low Pressure Female x NPT Female

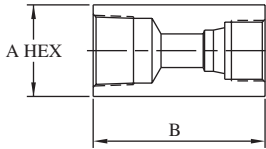

Catalog Number	Female L/P	Female NPT	A		B		Port	
LPC2L2P	1/8"	1/8"	0.50"	(12.7)	1.50"	(38.1)	0.093"	(2.4)
LPC2L4P	1/8"	1/4"	0.75"	(19.1)	1.50"	(38.1)	0.093"	(2.4)
LPC2L6P	1/8"	3/8"	1.00"	(25.4)	1.56"	(39.6)	0.093"	(2.4)
LPC2L8P	1/8"	1/2"	1.38"	(35.1)	2.00"	(50.8)	0.093"	(2.4)
LPC4L2P	1/4"	1/8"	0.75"	(19.1)	1.75"	(44.5)	0.187"	(4.7)
LPC4L4P	1/4"	1/4"	0.75"	(19.1)	1.50"	(38.1)	0.187"	(4.7)
LPC4L6P	1/4"	3/8"	1.00"	(25.4)	2.12"	(53.8)	0.187"	(4.7)
LPC4L8P	1/4"	1/2"	1.38"	(35.1)	2.00"	(50.8)	0.187"	(4.7)
LPC6L2P	3/8"	1/8"	0.75"	(19.1)	1.62"	(41.1)	0.187"	(4.7)
LPC6L4P	3/8"	1/4"	0.75"	(19.1)	1.62"	(41.1)	0.312"	(7.9)
LPC6L6P	3/8"	3/8"	1.00"	(25.4)	1.75"	(44.5)	0.312"	(7.9)
LPC6L8P	3/8"	1/2"	1.38"	(35.1)	2.25"	(57.2)	0.312"	(7.9)
LPC8L2P	1/2"	1/8"	1.00"	(25.4)	2.00"	(50.8)	0.339"	(8.6)
LPC8L4P	1/2"	1/4"	1.00"	(25.4)	2.00"	(50.8)	0.437"	(11.1)
LPC8L6P	1/2"	3/8"	1.00"	(25.4)	2.00"	(50.8)	0.437"	(11.1)
LPC8L8P	1/2"	1/2"	1.00"	(25.4)	2.00"	(50.8)	0.437"	(11.1)
LPC8L12P	1/2"	3/4"	1.75"	(44.5)	2.50"	(63.5)	0.437"	(11.1)

Medium Pressure Female x NPT Female

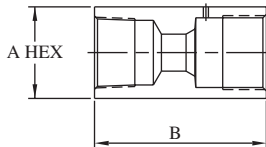

Catalog Number	Female M/P	Female NPT	A		B		Port	
10F4M2P	1/4"	1/8"	0.75"	(19.1)	1.50"	(38.1)	0.109"	(2.8)
10F4M4P	1/4"	1/4"	0.75"	(19.1)	1.50"	(38.1)	0.125"	(3.2)
10F4M6P	1/4"	3/8"	1.00"	(25.4)	1.62"	(41.1)	0.125"	(3.2)
10F4M8P	1/4"	1/2"	1.38"	(35.1)	2.12"	(53.8)	0.125"	(3.2)
10F6M2P	3/8"	1/8"	0.75"	(19.1)	1.75"	(44.5)	0.203"	(5.2)
10F6M4P	3/8"	1/4"	0.75"	(19.1)	1.75"	(44.5)	0.203"	(5.2)
10F6M6P	3/8"	3/8"	1.00"	(25.4)	1.68"	(42.7)	0.203"	(5.2)
10F6M8P	3/8"	1/2"	1.38"	(35.1)	2.12"	(53.8)	0.203"	(5.2)
10F9M2P	9/16"	1/8"	1.00"	(25.4)	2.00"	(50.8)	0.339"	(8.6)
10F9M4P	9/16"	1/4"	1.00"	(25.4)	2.00"	(50.8)	0.359"	(9.1)
10F9M6P	9/16"	3/8"	1.00"	(25.4)	2.00"	(50.8)	0.359"	(9.1)
10F9M8P	9/16"	1/2"	1.38"	(35.1)	2.25"	(57.2)	0.359"	(9.1)
10F9M12P	9/16"	3/4"	1.75"	(44.5)	2.50"	(63.5)	0.359"	(9.1)
10F9M16P	9/16"	1"	1.88"	(47.8)	2.44"	(62.0)	0.359"	(9.1)
10F12M2P	3/4"	1/8"	1.38"	(35.1)	2.50"	(63.5)	0.339"	(8.6)
10F12M4P	3/4"	1/4"	1.38"	(35.1)	2.50"	(63.5)	0.437"	(11.1)
10F12M6P	3/4"	3/8"	1.38"	(35.1)	2.50"	(63.5)	0.516"	(13.1)
10F12M8P	3/4"	1/2"	1.38"	(35.1)	2.50"	(63.5)	0.516"	(13.1)
10F12M12P	3/4"	3/4"	1.75"	(44.5)	2.50"	(63.5)	0.516"	(13.1)
10F12M16P	3/4"	1"	2.13"	(54.1)	2.75"	(69.9)	0.516"	(13.1)
10F16M2P	1"	1/8"	1.75"	(44.5)	3.00"	(76.2)	0.339"	(8.6)
10F16M4P	1"	1/4"	1.75"	(44.5)	3.00"	(76.2)	0.437"	(11.1)
10F16M6P	1"	3/8"	1.75"	(44.5)	3.00"	(76.2)	0.578"	(14.7)
10F16M8P	1"	1/2"	1.75"	(44.5)	3.00"	(76.2)	0.687"	(17.4)
10F16M12P	1"	3/4"	1.75"	(44.5)	3.00"	(76.2)	0.687"	(17.4)
10F16M16P	1"	1"	2.13"	(54.1)	3.50"	(88.9)	0.687"	(17.4)

NOTE: See page ACC-1 to determine maximum allowable working pressure (MAWP)

All dimensions are for reference only and are subject to change.
Dimensions in parentheses are millimeters (mm).

FEMALE-FEMALE COUPLINGS

High Pressure Female x NPT Female

Catalog Number	Female H/P	Female NPT	A		B		Port	
10F4H2P	1/4"	1/8"	0.75"	(19.1)	1.50"	(38.1)	0.093"	(2.4)
10F4H4P	1/4"	1/4"	0.75"	(19.1)	1.50"	(38.1)	0.093"	(2.4)
10F4H6P	1/4"	3/8"	1.00"	(25.4)	1.62"	(41.1)	0.093"	(2.4)
10F4H8P	1/4"	1/2"	1.38"	(35.1)	2.12"	(53.8)	0.093"	(2.4)
10F6H2P	3/8"	1/8"	1.00"	(25.4)	1.75"	(44.5)	0.125"	(3.2)
10F6H4P	3/8"	1/4"	1.00"	(25.4)	1.75"	(44.5)	0.125"	(3.2)
10F6H6P	3/8"	3/8"	1.00"	(25.4)	1.75"	(44.5)	0.125"	(3.2)
10F6H8P	3/8"	1/2"	1.38"	(35.1)	2.12"	(53.8)	0.125"	(3.2)
10F9H2P	9/16"	1/8"	1.38"	(35.1)	2.25"	(57.2)	0.187"	(4.7)
10F9H4P	9/16"	1/4"	1.38"	(35.1)	2.25"	(57.2)	0.187"	(4.7)
10F9H6P	9/16"	3/8"	1.38"	(35.1)	2.25"	(57.2)	0.187"	(4.7)
10F9H8P	9/16"	1/2"	1.38"	(35.1)	2.25"	(57.2)	0.187"	(4.7)
10F9H12P	9/16"	3/4"	1.38"	(35.1)	2.50"	(63.5)	0.187"	(4.7)

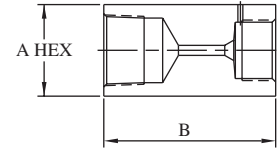

Medium Pressure Female x Medium Pressure Female

Catalog Number	Female M/P	Female M/P	A		B		Port	
20F4M6M	1/4"	3/8"	0.75"	(19.1)	1.75"	(44.5)	0.109"	(2.8)
20F4M9M	1/4"	9/16"	1.00"	(25.4)	2.00"	(50.8)	0.109"	(2.8)
20F4M12M	1/4"	3/4"	1.38"	(35.1)	2.50"	(63.5)	0.109"	(2.8)
20F4M16M	1/4"	1"	1.75"	(44.5)	3.00"	(76.2)	0.109"	(2.8)
20F6M9M	3/8"	9/16"	1.00"	(25.4)	2.00"	(50.8)	0.203"	(5.2)
20F6M12M	3/8"	3/4"	1.38"	(35.1)	2.50"	(63.5)	0.203"	(5.2)
20F6M16M	3/8"	1"	1.75"	(44.5)	3.00"	(76.2)	0.203"	(5.2)
20F9M12M	9/16"	3/4"	1.38"	(35.1)	2.50"	(63.5)	0.312"	(7.9)
20F9M16M	9/16"	1"	1.75"	(44.5)	3.00"	(76.2)	0.359"	(9.1)
20F12M16M	3/4"	1"	1.75"	(44.5)	3.00"	(76.2)	0.516"	(13.1)

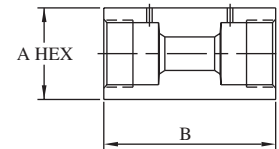

Medium Pressure Female x High Pressure Female

Catalog Number	Female M/P	Female H/P	A		B		Port	
20F4M4H	1/4"	1/4"	0.75"	(19.1)	1.50"	(38.1)	0.093"	(2.4)
20F4M6H	1/4"	3/8"	1.00"	(25.4)	1.75"	(44.5)	0.109"	(2.8)
20F4M9H	1/4"	9/16"	1.38"	(35.1)	2.25"	(57.2)	0.109"	(2.8)
20F6M4H	3/8"	1/4"	0.75"	(19.1)	1.75"	(44.5)	0.093"	(2.4)
20F6M6H	3/8"	3/8"	1.00"	(25.4)	1.75"	(44.5)	0.125"	(3.2)
20F6M9H	3/8"	9/16"	1.38"	(35.1)	2.25"	(57.2)	0.187"	(4.7)
20F9M4H	9/16"	1/4"	1.00"	(25.4)	2.00"	(50.8)	0.093"	(2.4)
20F9M6H	9/16"	3/8"	1.00"	(25.4)	2.00"	(50.8)	0.125"	(3.2)
20F9M9H	9/16"	9/16"	1.38"	(35.1)	2.25"	(57.2)	0.187"	(4.7)
20F12M4H	3/4"	1/4"	1.38"	(35.1)	2.50"	(63.5)	0.093"	(2.4)
20F12M6H	3/4"	3/8"	1.38"	(35.1)	2.50"	(63.5)	0.125"	(3.2)
20F12M9H	3/4"	9/16"	1.38"	(35.1)	2.50"	(63.5)	0.187"	(4.7)
20F16M4H	1"	1/4"	1.75"	(44.5)	3.00"	(76.2)	0.093"	(2.4)
20F16M6H	1"	3/8"	1.75"	(44.5)	3.00"	(76.2)	0.125"	(3.2)
20F16M9H	1"	9/16"	1.75"	(44.5)	3.00"	(76.2)	0.187"	(4.7)

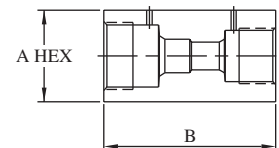

High Pressure Female x High Pressure Female

Catalog Number	Female H/P	Female H/P	A		B		Port	
60F4H6H	1/4"	3/8"	1.00"	(25.4)	1.75"	(44.5)	0.093"	(2.4)
60F4H9H	1/4"	9/16"	1.38"	(35.1)	2.25"	(57.2)	0.093"	(2.4)
60F6H9H	3/8"	9/16"	1.38"	(35.1)	2.25"	(57.2)	0.125"	(3.2)

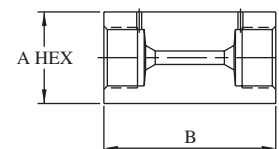

NOTE: See page ACC-1 to determine maximum allowable working pressure (MAWP)



All dimensions are for reference only and are subject to change.
Dimensions in parentheses are millimeters (mm).

HIGH PRESSURE HOSE

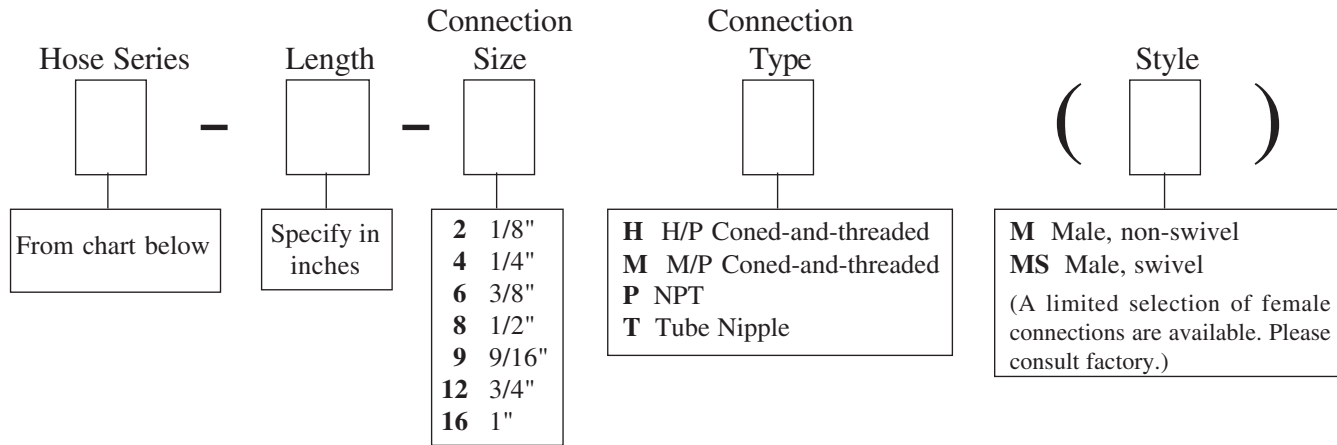

Example:

16.4H-.25-120-8P (M x MS) specifies a 0.25" ID Hose rated 16,400 PSI, 120" long, with 1/2" NPT connections, one end swivel.

BuTech offers a variety of high pressure hose for waterjet cutting, high pressure testing and hydraulics.

Outer covers are manufactured from Extruded Nylon 11 or can be specified in polyurethane. Hose cores are Nylon 11 with one braided plus two spiral wound layers of plated high strength steel wire for pressure support, or Delrin or Nylon 11 with four spiral wound layers of plated high strength steel wire for pressure support.

All hose assemblies are tested to 1.5 x Working pressure and are available with choice of female or male NPT end connections in 1/8", 1/4", 3/8", 1/2", 3/4", and 1" sizes. Operating temperature range is -40° to +140°F (-40° to 60°C).



Hose Series	Working Pressure		Hose I.D.		Hose O.D.		Insert I.D.	
	PSI	bar	Inches	MM	Inches	MM	Inches	MM
6.4H-1.00	6,400	440	1.00	25.4	1.34	34.0	0.72	18.3
6.5H-1.00	6,500	450	1.00	25.4	1.37	34.8	0.69	17.5
8H-.14	8,000	550	0.14	3.6	0.27	6.9	0.07	1.8
8.1H-.81	8,100	560	0.81	20.6	1.14	29.0	0.56	14.2
8.4H-.50	8,400	580	0.50	12.7	0.81	20.6	0.35	8.9
9.28H-.11	9,280	640	0.11	2.8	0.23	5.8	0.08	2.0
10.3H-.40	10,300	710	0.40	10.2	0.70	17.8	0.23	5.8
10.4H-.25	10,400	720	0.25	6.4	0.50	12.7	0.17	4.3
10.4H-.50	10,400	720	0.50	12.7	0.81	20.6	0.35	8.9
12H-.25	12,000	830	0.25	6.4	0.52	13.2	0.13	3.3
12.4H-.50	12,400	850	0.50	12.7	0.87	22.1	0.35	8.9
13.05H-1.00	13,050	900	1.00	25.4	1.46	37.1	0.69	17.5
13.2H-.25	13,200	910	0.25	6.4	0.50	12.7	0.17	4.3
13.6H-.32	13,600	940	0.32	8.1	0.62	15.7	0.18	4.6
14H-.25	14,000	970	0.25	6.4	0.50	12.7	0.17	4.3
15H-.17	15,000	1030	0.17	4.3	0.31	7.9	0.10	2.5
15H-.20	15,000	1030	0.20	5.1	0.42	10.7	0.13	3.3
15H-.81	15,000	1030	0.81	20.6	1.19	30.2	0.53	13.5
16.4H-.25	16,400	1130	0.25	6.4	0.54	13.7	0.13	3.3
17.4H-.16	17,400	1200	0.16	4.1	0.39	9.9	0.08	2.0
20.3H-.80	20,300	1400	0.80	20.3	1.30	33.0	0.53	13.5
20.4H-.50	20,400	1410	0.50	12.7	0.88	22.4	0.30	7.6
22.5H-.25	22,500	1550	0.25	6.4	0.50	12.7	0.13	3.3
23H-.33	23,000	1590	0.33	8.4	0.61	15.5	0.18	4.6
26H-.20	26,000	1790	0.20	5.1	0.43	10.9	0.07	1.8
26H-.50	26,000	1790	0.50	12.7	0.97	24.6	0.31	7.9
30H-.15	30,000	2070	0.15	3.8	0.37	9.4	0.10	2.5
36H-.33	36,000	2480	0.33	8.4	0.68	17.3	0.18	4.6
36.25H-.20	36,250	2500	0.20	5.1	0.50	12.7	0.09	2.3
40H-.20	40,000	2760	0.20	5.1	0.50	12.7	0.09	2.3
40.6H-.15	40,600	2800	0.15	3.8	0.42	10.7	0.08	2.0
48H-.20	48,000	3310	0.20	5.1	0.57	14.5	0.08	2.0
60H-.20	60,000	4140	0.20	5.1	1.57	39.9	0.08	2.0

All dimensions are for reference only and are subject to change.
Dimensions in parentheses are millimeters (mm).

THERMOCOUPLES & GAUGE SNUBBERS

BuTech Thermocouples permit quick and accurate temperature monitoring at any point in the system. Sheath lengths are standardized for use with any tee or cross shown in this catalog. To order custom lengths, add the desired length to the catalog number. (Example: 20TCJ6-8" would be an 8" sheath length that would fit into the standard 3/8" M/P connection.)



- Standard quick connectors, both male and female, supplied with thermocouple
- Small diameter sheath to give fast response time
- Sheath has grounded junction
- 300 series SS sheath standard, other materials available on request
- Can be directly installed into any standard tee or cross.
- Working pressures to 60,000 PSI (4140 bar)
- 1/4" thermocouple supplied complete with collar and gland; other sizes supplied complete with 316SS adapter and necessary collars and glands to fit into standard connection.
- Standard thermocouples available with either type J or type K calibration. Other types available on special order.
- Temperature at the tip of the thermocouple can range to 2,000°F (1093°C)

Connection	Catalog Number		MAWP
	Type J Calibration	Type K Calibration	
1/4" M/P	20TCJ4	20TCK4	20,000 PSI 1380 bar
3/8" M/P	20TCJ6	20TCK6	20,000 PSI 1380 bar
9/16" M/P	20TCJ9	20TCK9	20,000 PSI 1380 bar
3/4" M/P	20TCJ12	20TCK12	20,000 PSI 1380 bar
1" M/P	20TCJ16	20TCK16	20,000 PSI 1380 bar
1/4" H/P	60TCJ4	60TCK4	60,000 PSI 4140 bar
3/8" H/P	60TCJ6	60TCK6	60,000 PSI 4140 bar
9/16" H/P	60TCJ9	60TCK9	60,000 PSI 4140 bar

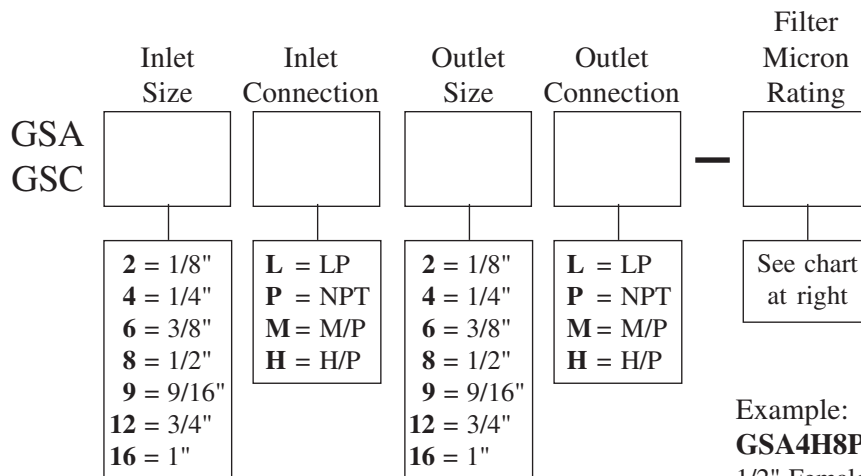

Micron Rating	Service Recommendations	Replacement Disc P/N
2	Gases, Severe Pulsing	PH-1103
5	Air, Gases, Vapors	PH-1104
10	Water, Light Oils	PH-1105
20	Heavy Oils	PH-1021

Example:
GSA4H8P-5 specifies a snubber with 1/4" H/P Male inlet and 1/2" Female NPT outlet with a 5 micron disc

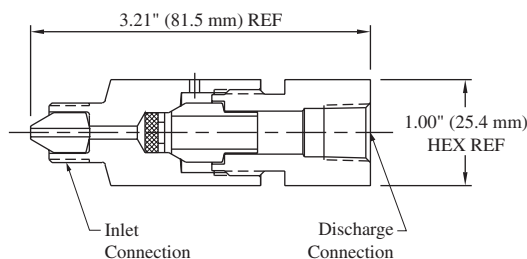

BuTech Gauge Snubbers protect gauges and instruments from pressure surges and shock. This is accomplished through the use of porous sintered 316 stainless steel filter discs. BuTech gauge snubbers are available with a wide variety of connection configurations for pressures up to 60,000 PSI @ 72°F (4140 bar @ 22°C). **GSA** series has a male inlet with a female outlet, **GSC** series has female inlet and outlet.

All dimensions are for reference only and are subject to change.
Dimensions in parentheses are millimeters (mm).



PRESSURE GAUGES

BuTech offers a line of gauges for indication of system pressure. All gauges are supplied with 1/4" H/P Coned and Threaded connections. Various adapters are available for use with medium and high pressure component systems.

Design Features

- Designed to Class AA standards: 1/4 of 1% accuracy
- Impact resistant aluminum case
- Black epoxy finish
- Solid front provides maximum safety with a solid wall between the Bourdon tube and window
- Blowout disc covers entire rear of gauge for pressure relief should Bourdon tube fail
- 316SS Bourdon tube and socket
- Other materials are available on request

Options

- Electric Contact Face - Add **-ECF** to catalog number
- Liquid Filled - Add **-LF** to catalog number

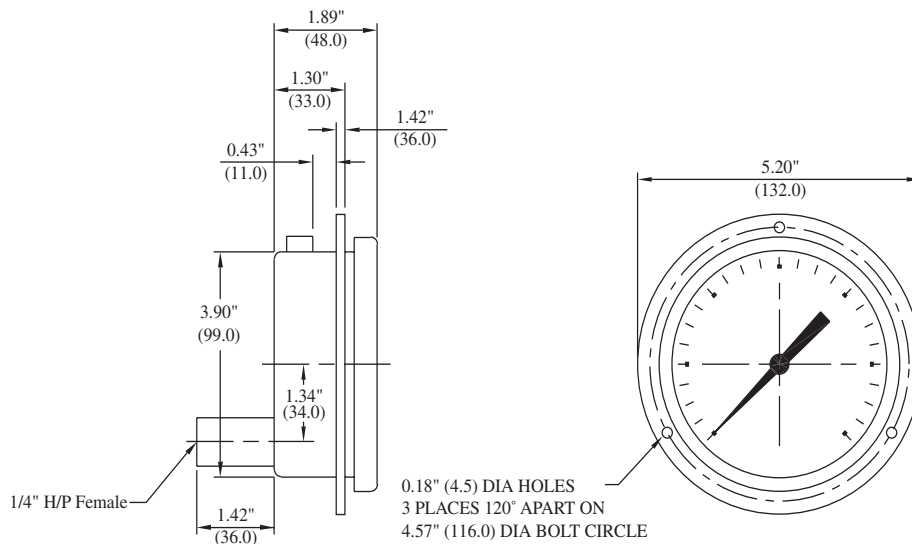

Pressure Range	Pressure Divisions	Bottom Connected Gauges		Back Connected Gauges	
		Wall Mount	Flush Mount	Wall Mount	Flush Mount
1,000 PSI 70 bar	10 PSI 0.7 bar	1MG	1MG-PM	1MGB	1MGB-PM
2,000 PSI 140 bar	20 PSI 1.4 bar	2MG	2MG-PM	2MGB	2MGB-PM
3,000 PSI 210 bar	25 PSI 1.7 bar	3MG	3MG-PM	3MGB	3MGB-PM
5,000 PSI 340 bar	50 PSI 3.4 bar	5MG	5MG-PM	5MGB	5MGB-PM
7,500 PSI 520 bar	50 PSI 3.4 bar	7.5MG	7.5MG-PM	7.5MGB	7.5MGB-PM
10,000 PSI 690 bar	100 PSI 6.9 bar	10MG	10MG-PM	10MGB	10MGB-PM

All dimensions are for reference only and are subject to change.
Dimensions in parentheses are millimeters (mm).

PRESSURE GAUGES

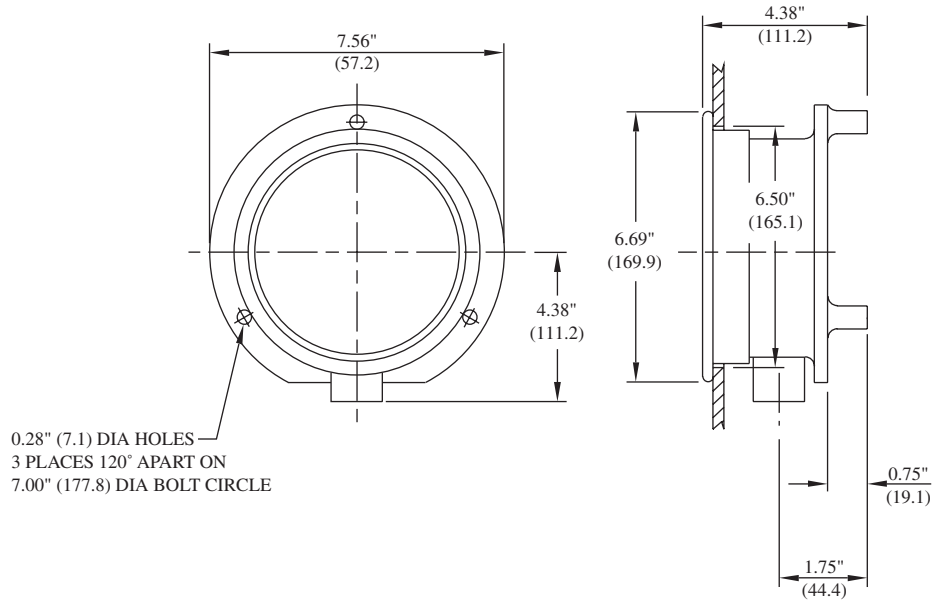

Pressure Range	Pressure Divisions	Bottom Connected Gauges		Back Connected Gauges	
		Wall Mount	Flush Mount	Wall Mount	Flush Mount
15,000 PSI 1030 bar	100 PSI 7 bar	15AG	15AG-PM	15AGB	15AGB-PM
20,000 PSI 1380 bar	200 PSI 14 bar	20AG	20AG-PM	20AGB	20AGB-PM
30,000 PSI 2070 bar	250 PSI 17 bar	30AG	30AG-PM	30AGB	30AGB-PM
50,000 PSI 3450 bar	500 PSI 34 bar	50AG	50AG-PM	50AGB	50AGB-PM
75,000 PSI 5170 bar	500 PSI 34 bar	75AG	75AG-PM	75AGB	75AGB-PM
100,000 PSI 6890 bar	1,000 PSI 69 bar	100AG	100AG-PM	100AGB	100AGB-PM

All dimensions are for reference only and are subject to change.
Dimensions in parentheses are millimeters (mm).

EQUIPMENT FOR SOUR GAS SERVICE

BuTech Sour Gas Valves, Fittings and Tubing are designed to withstand H₂S Sour Oil and Gas high pressure environments. BuTech components are designed for shutoff service, gauge mounting, or installation of tubing systems for recording of pressures at remote locations. Other applications include research and testing laboratories engaged in the use of hydrogen sulfide.

Available in a variety of body styles, the SOG valves are designed for operation at pressures ranging to 30,000 PSI at 100°F (2070 bar at 38°C).

BuTech wellhead components meet NACE MR-01-75 and standards issued by the American Petroleum Institute.

Manufacturing and assembly processes are subject to rigid quality control procedures including non-destructive testing at appropriate stages to ensure specification compliance on component products. Records are maintained to verify compliance in material procurement, heat treating, and testing. Certification of testing and specification compliance is available upon request.

Needle Valve Features:

- 316 annealed stainless steel body
- One-piece K-Monel Stem in two styles:
 - Vee style for on-off service
 - Regulating style for on-off and flow control service
- Glass-filled teflon and Nylatron packings
- Integral through holes for bracket mounting. A panel-mounting option is also available (see page SOG-2)
- Wide range of options allow customizing of valve
- Positive gland locking device

Tube Sizes: 1/4" through 9/16"
Pressures to 30,000 PSI (2070 bar)
Type: H/P Cone-and-Thread

Tube O.D.	Connection	Orifice	Cv*	MAWP+
1/4"	1/4" H/P	0.093" (2.4 mm)	0.08	30,000 PSI 2070 bar
3/8"	3/8" H/P	0.125" (3.2 mm)	0.09	30,000 PSI 2070 bar
9/16"	9/16" H/P	0.125" (3.2 mm)	0.14	30,000 PSI 2070 bar

*Cv values listed are for 2-way straight pattern valves.

For 2-way angle pattern valves, increase Cv value by 50%.

+Maximum allowable working pressure at 72° F (22° C)

Equipment	Page
Adapters	SOG-12
Anti-Vibration Glands	SOG-15
Bleed Valves	SOG-3
Bulkhead Couplings	SOG-10
Caps	SOG-15
Check Valves	SOG-16
Collars	SOG-15
Couplings	SOG-11
Crosses	SOG-10
Elbows	SOG-10
Filters	SOG-17
Glands	SOG-15
Needle Valves, 20,000 PSI	SOG-4
Needle Valves, 30,000 PSI	SOG-7
Nipples	SOG-14
Plugs	SOG-15
Safety Heads	SOG-18
Sub-Sea Equipment	SOG-19
Tees	SOG-10
Tubing	SOG-14
Wellhead Gauge Valves	SOG-3

Equipment for sour gas service supplied without collars and glands unless otherwise specified

All dimensions are for reference only and are subject to change.
 Dimensions in parentheses are millimeters (mm)



ORDERING INFORMATION & REPLACEMENT PARTS

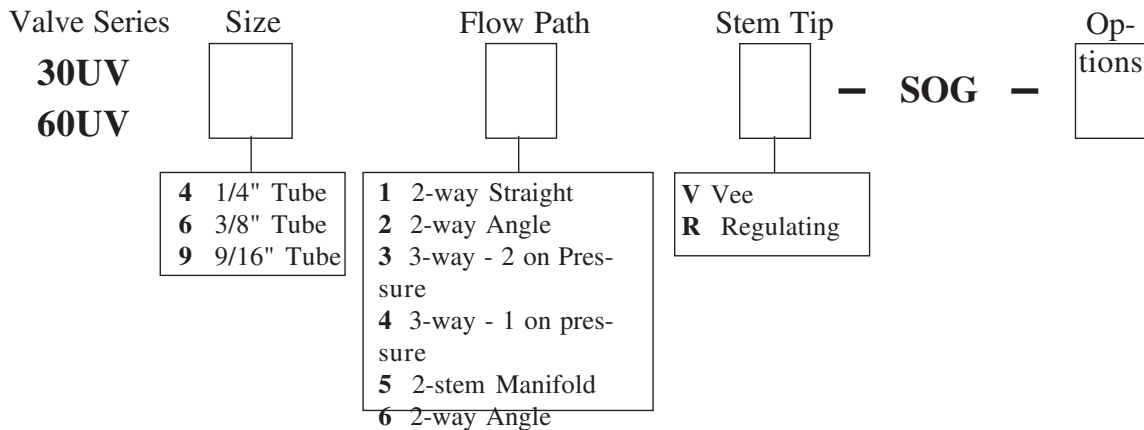

Examples:

30UV42V-SOG specifies a 2-way angle valve for 1/4" tube with a Vee stem

60UV91R-SOG-PM specifies a 2-way straight valve for 9/16" tube with regulating stem and panel-mount packing gland option

Panel Mount Option

-PM Panel-mount packing gland

Valve Model	Panel Hole Size	Max Panel Thickness	H
30UV	0.84" (21.3)	0.37" (9.4)	0.48" (12.2)
60UV	0.84" (21.3)	0.37" (9.4)	0.48" (12.2)

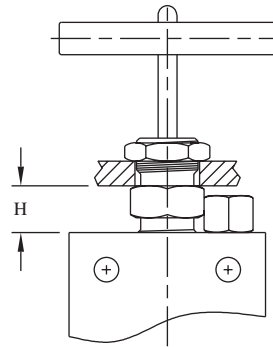

Replacement Parts

BuTech offers replacement parts in a variety of packages so you can purchase just the parts you need.

Replacement Stem Kit contains just the stem

Replacement Packing Kit contains all soft packing rings

Repair Kits contain stem, stem sleeve, stem nuts and washers, packings and packing washers (replacement seat where applicable)

Valve Series	Repair Kits		Replacement Stem	Replacement Packings	Replacement Valve Body
	All others	Replaceable Seat			
30UV4	RK-30UV4*-SOG	RK-30UV46*-SOG	30S4*-SOG	30PK4	30UV4+-SOG
30UV6	RK-30UV6*-SOG	RK-30UV66*-SOG	30S6*-SOG	30PK6	30UV6+-SOG
30UV9	RK-30UV9*-SOG	RK-30UV96*-SOG	30S9*-SOG	30PK9	30UV9+-SOG
60UV4	RK-60UV4*-SOG	RK-60UV46*-SOG	60S4*-SOG	60PK4	60UV4+-SOG
60UV6	RK-60UV6*-SOG	RK-60UV66*-SOG	60S6*-SOG	60PK6	60UV6+-SOG
60UV9	RK-60UV9*-SOG	RK-60UV96*-SOG	60S9*-SOG	60PK9	60UV9+-SOG

*Complete catalog number by adding **V** or **R** for stem type

+Complete catalog number by adding the flow path designator:

- 1 2-way straight
- 2 2-way angle
- 3 3-way, 2 connections on pressure
- 4 3-way, 1 connection on pressure
- 5 2-stem manifold
- 6 2-way angle with replaceable seat

All dimensions are for reference only and are subject to change.
Dimensions in parentheses are millimeters (mm)

WELLHEAD GAUGE & BLEED VALVES

BuTech Wellhead Gauge and Bleed valves are standard 316 stainless steel annealed material for SOG service and comply with NACE MR-01-75. Special materials available on request.

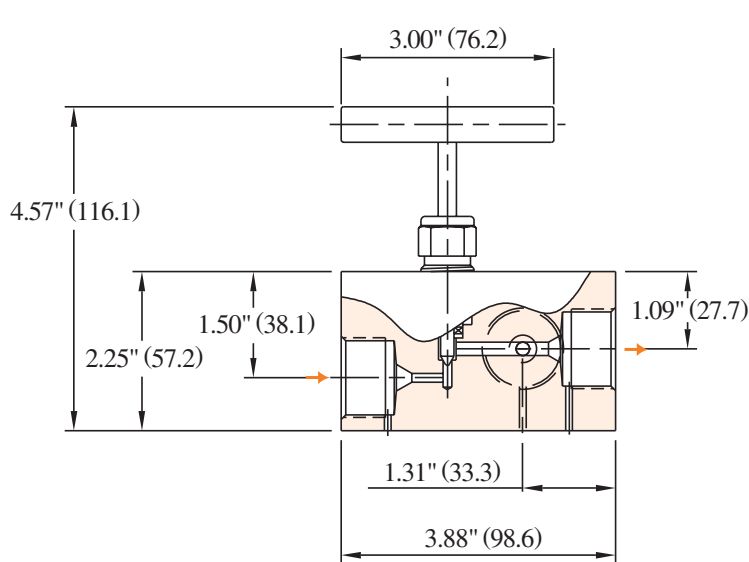

Wellhead Gauge Valve 30WGV97V-SOG

- One inlet, three outlet ports
- Ideal for sampling or instrument calibration
- Packing located below stem threads
- Metal-to-metal seat for bubble-tight shutoff
- One-piece stem
- Collars & Glands not included

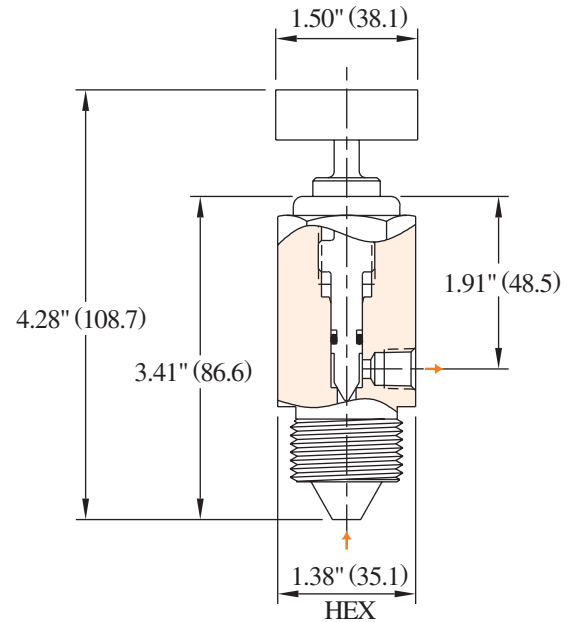

Bleed Valve 30ABV9H2P-SOG

- Vent port tapped for safe plumbing
- Positive blow-out prevention on stem
- Easy T-handle operation
- Metal-to-metal seat for bubble-tight shutoff
- One-piece stem
- Compatible with standard API test and gauge connections for 20,000 PSI (1380 bar) service

Catalog Number	30WGV97V-SOG	30ABV9H2P-SOG
Service	Sour Oil & Gas	Sour Oil & Gas
Inlet Port	9/16" Female H/P	9/16" Male H/P
Discharge Port	(3) 9/16" Female H/P	1/8" Female NPT
Pressure Rating at 72°F (22°C)	20,000 PSI 1380 bar	20,000 PSI 1380 bar
Standard Material Other materials available upon request	316 annealed stainless steel	316 annealed stainless steel

All dimensions are for reference only and are subject to change.
Dimensions in parentheses are millimeters (mm)

NEEDLE VALVES FOR 20,000 PSI (1380 BAR)

1/4" H/P TUBE
CONED AND THREADED

2-way Straight

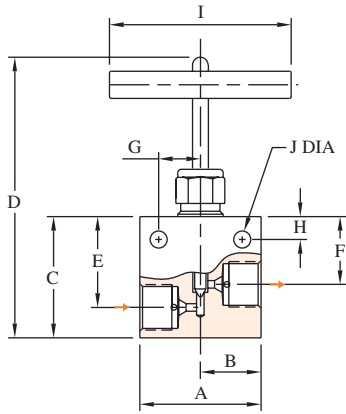

Figure 1

2-way Angle

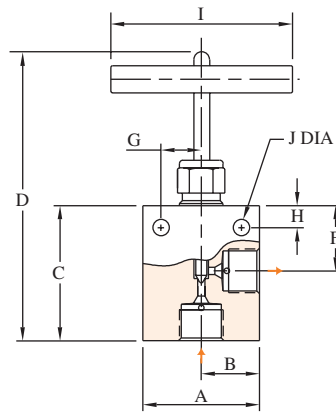

Figure 2

3-way Two on Pressure

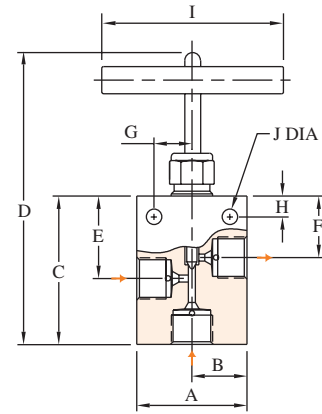

Figure 3

Catalog Number	Stem Style	A	B	C	D	E	F	G	H	I	J	K	L	Thk.	Fig
30UV41V-SOG	Vee	2.00"	1.00"	2.00"	4.77"	1.50"	1.12"	0.69"	0.38"	3.00"	0.28"	---	---	1.00"	1
30UV41R-SOG	Reg	(50.8)	(25.4)	(50.8)	(121.2)	(38.1)	(28.4)	(17.5)	(9.7)	(76.2)	(7.1)	---	---	(25.4)	
30UV42V-SOG	Vee	2.00"	1.00"	2.00"	4.77"	---	1.12"	0.69"	0.38"	3.00"	0.28"	---	---	1.00"	2
30UV42R-SOG	Reg	(50.8)	(25.4)	(50.8)	(121.2)	---	(28.4)	(17.5)	(9.7)	(76.2)	(7.1)	---	---	(25.4)	
30UV43V-SOG	Vee	2.00"	1.00"	2.12"	4.89"	1.50"	1.12"	0.69"	0.38"	3.00"	0.28"	---	---	1.00"	3
30UV43R-SOG	Reg	(50.8)	(25.4)	(53.8)	(124.2)	(38.1)	(28.4)	(17.5)	(9.7)	(76.2)	(7.1)	---	---	(25.4)	
30UV44V-SOG	Vee	2.00"	1.00"	2.00"	4.77"	1.12"	1.12"	0.69"	0.38"	3.00"	0.28"	---	---	1.00"	4
30UV44R-SOG	Reg	(50.8)	(25.4)	(50.8)	(121.2)	(28.4)	(28.4)	(17.5)	(9.7)	(76.2)	(7.1)	---	---	(25.4)	
30UV45V-SOG	Vee	2.00"	1.00"	3.06"	8.60"	1.53"	1.12"	0.69"	0.38"	3.00"	0.28"	---	---	1.00"	5
30UV45R-SOG	Reg	(50.8)	(25.4)	(77.7)	(218.4)	(38.9)	(28.4)	(17.5)	(9.7)	(76.2)	(7.1)	---	---	(25.4)	
30UV46V-SOG	Vee	2.00"	1.00"	2.38"	5.15"	---	1.12"	0.69"	0.38"	3.00"	0.28"	0.75"	1.47"	1.00"	6
30UV46R-SOG	Reg	(50.8)	(25.4)	(60.5)	(130.8)	---	(28.4)	(17.5)	(9.7)	(76.2)	(7.1)	(19.1)	(37.3)	(25.4)	

See page SOG-1 for orifice and Cv

3-way One on Pressure

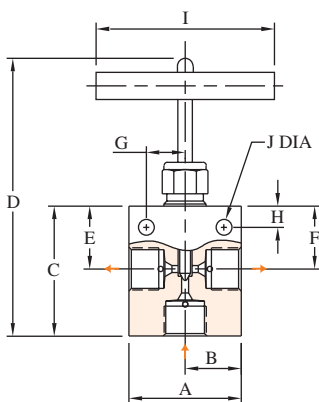

Figure 4

2-stem Manifold

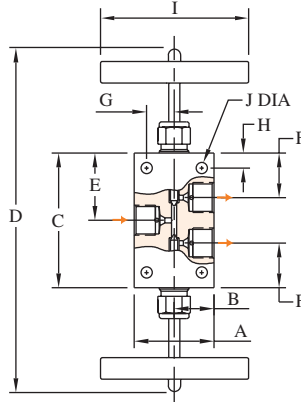

Figure 5

Replaceable Seat

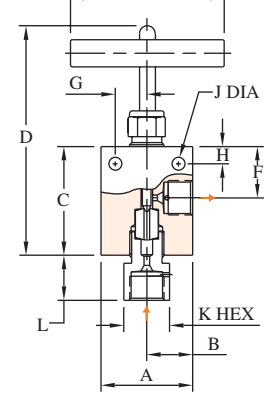

Figure 6

All dimensions are for reference only and are subject to change.
Dimensions in parentheses are millimeters (mm)

NEEDLE VALVES FOR 20,000 PSI (1380 BAR)

**3/8" H/P TUBE
CONED AND THREADED**

2-way Straight

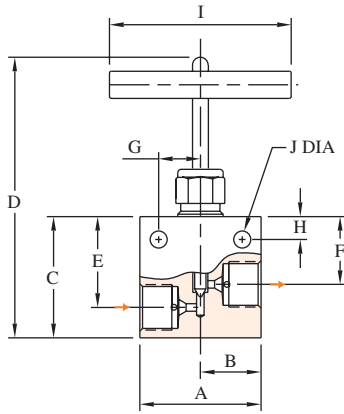

Figure 1

2-way Angle

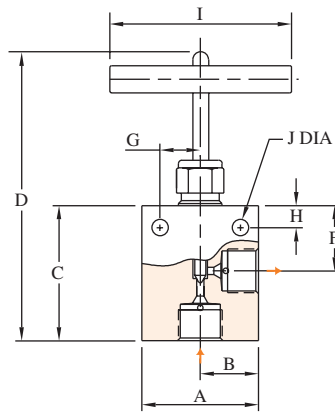

Figure 2

3-way Two on Pressure

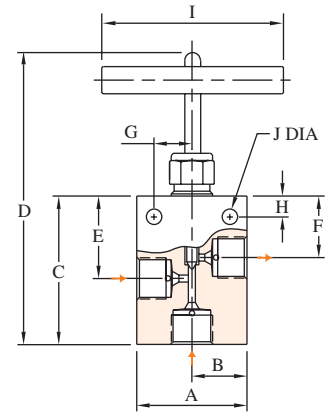

Figure 3

Catalog Number	Stem Style	A	B	C	D	E	F	G	H	I	J	K	L	Thk.	Fig
30UV61V-SOG	Vee	2.00"	1.00"	2.00"	4.77"	1.50"	1.12"	0.69"	0.38"	3.00"	0.28"	---	---	1.00"	1
30UV61R-SOG	Reg	(50.8)	(25.4)	(50.8)	(121.2)	(38.1)	(28.4)	(17.5)	(9.7)	(76.2)	(7.1)	---	---	(25.4)	
30UV62V-SOG	Vee	2.00"	1.00"	2.12"	4.89"	---	1.12"	0.69"	0.38"	3.00"	0.28"	---	---	1.00"	2
30UV62R-SOG	Reg	(50.8)	(25.4)	(53.8)	(124.2)	---	(28.4)	(17.5)	(9.7)	(76.2)	(7.1)	---	---	(25.4)	
30UV63V-SOG	Vee	2.00"	1.00"	2.50"	5.32"	1.50"	1.12"	0.69"	0.38"	3.00"	0.28"	---	---	1.00"	3
30UV63R-SOG	Reg	(50.8)	(25.4)	(63.5)	(135.1)	(38.1)	(28.4)	(17.5)	(9.7)	(76.2)	(7.1)	---	---	(25.4)	
30UV64V-SOG	Vee	2.00"	1.00"	2.12"	4.89"	1.12"	1.12"	0.69"	0.38"	3.00"	0.28"	---	---	1.00"	4
30UV64R-SOG	Reg	(50.8)	(25.4)	(53.8)	(124.2)	(28.4)	(28.4)	(17.5)	(9.7)	(76.2)	(7.1)	---	---	(25.4)	
30UV65V-SOG	Vee	2.00"	1.00"	3.25"	8.79"	1.62"	1.12"	0.69"	0.38"	3.00"	0.28"	---	---	1.00"	5
30UV65R-SOG	Reg	(50.8)	(25.4)	(82.6)	(223.3)	(41.1)	(28.4)	(17.5)	(9.7)	(76.2)	(7.1)	---	---	(25.4)	
30UV66V-SOG	Vee	2.00"	1.00"	2.38"	5.15"	---	1.12"	0.69"	0.38"	3.00"	0.28"	1.00"	1.15"	1.00"	6
30UV66R-SOG	Reg	(50.8)	(25.4)	(60.5)	(130.8)	---	(28.4)	(17.5)	(9.7)	(76.2)	(7.1)	(25.4)	(29.2)	(25.4)	

See page SOG-1 for orifice and Cv

3-way One on Pressure

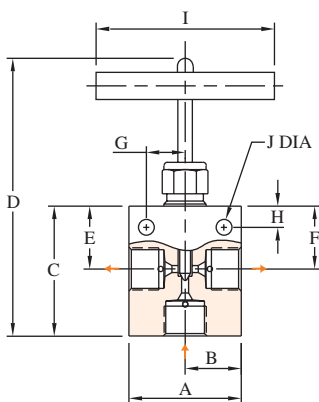

Figure 4

2-stem Manifold

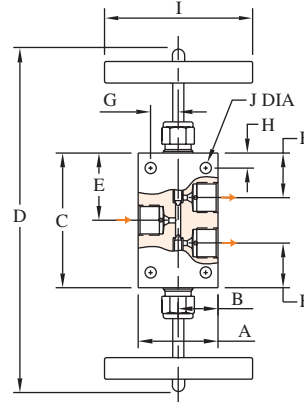

Figure 5

Replaceable Seat

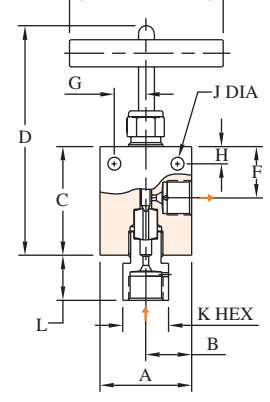

Figure 6

All dimensions are for reference only and are subject to change.
Dimensions in parentheses are millimeters (mm)



NEEDLE VALVES FOR 20,000 PSI (1380 BAR)

9/16" H/P TUBE
CONED AND THREADED

2-way Straight

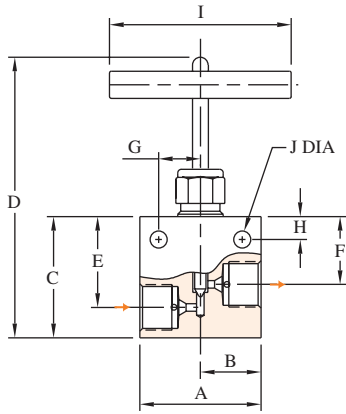

Figure 1

2-way Angle

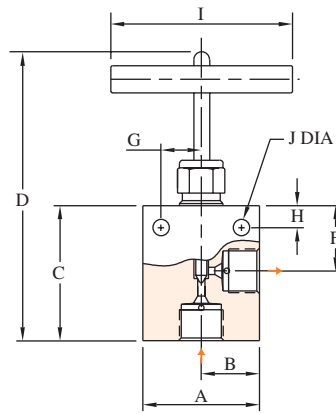

Figure 2

3-way Two on Pressure

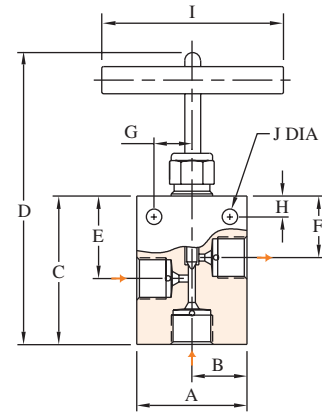

Figure 3

Catalog Number	Stem Style	A	B	C	D	E	F	G	H	I	J	K	L	Thk.	Fig
30UV91V-SOG	Vee	2.62"	1.31"	2.44"	5.20"	1.56"	1.12"	0.69"	0.38"	3.00"	0.25"	---	---	1.50"	1
30UV91R-SOG	Reg	(66.5)	(33.3)	(62.0)	(132.1)	(39.6)	(28.4)	(17.5)	(9.7)	(76.2)	(6.4)	---	---	(38.1)	
30UV92V-SOG	Vee	2.62"	1.31"	3.00"	5.44"	---	1.62"	0.69"	0.38"	3.00"	0.28"	---	---	1.50"	2
30UV92R-SOG	Reg	(66.5)	(33.3)	(76.2)	(138.2)	---	(41.1)	(17.5)	(9.7)	(76.2)	(7.1)	---	---	(38.1)	
30UV93V-SOG	Vee	2.62"	1.31"	2.88"	5.65"	1.56"	1.12"	0.69"	0.38"	3.00"	0.28"	---	---	1.50"	3
30UV93R-SOG	Reg	(66.5)	(33.3)	(73.2)	(143.5)	(39.6)	(28.4)	(17.5)	(9.7)	(76.2)	(7.1)	---	---	(38.1)	
30UV94V-SOG	Vee	2.62"	1.31"	2.44"	5.21"	1.12"	1.12"	0.69"	0.38"	3.00"	0.28"	---	---	1.50"	4
30UV94R-SOG	Reg	(66.5)	(33.3)	(62.0)	(132.3)	(28.4)	(28.4)	(17.5)	(9.7)	(76.2)	(7.1)	---	---	(38.1)	
30UV95V-SOG	Vee	2.62"	1.31"	4.75"	10.29"	2.38"	1.62"	0.69"	0.50"	3.00"	0.28"	---	---	1.50"	5
30UV95R-SOG	Reg	(66.5)	(33.3)	(120.7)	(261.4)	(60.5)	(41.1)	(17.5)	(12.7)	(76.2)	(7.1)	---	---	(38.1)	
30UV96V-SOG	Vee	2.62"	1.31"	2.44"	5.21"	---	1.19"	0.69"	0.38"	3.00"	0.28"	1.38"	1.65"	1.50"	6
30UV96R-SOG	Reg	(66.5)	(33.3)	(62.0)	(132.3)	---	(30.2)	(17.5)	(9.7)	(76.2)	(7.1)	(35.1)	(41.9)	(38.1)	

See page SOG-1 for orifice and Cv

3-way One on Pressure

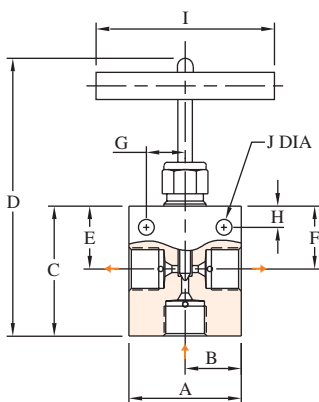

Figure 4

2-stem Manifold

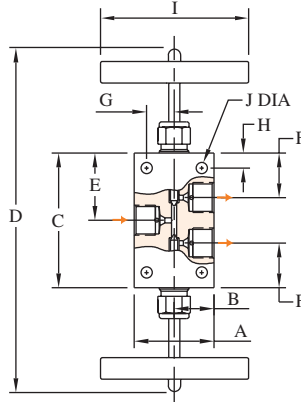

Figure 5

Replaceable Seat

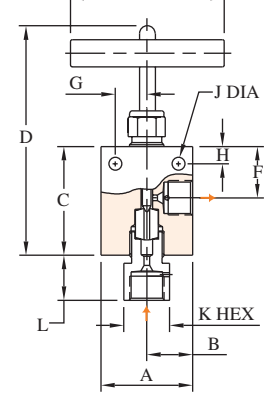

Figure 6

All dimensions are for reference only and are subject to change.
Dimensions in parentheses are millimeters (mm)

NEEDLE VALVES FOR 30,000 PSI (2070 BAR)

1/4" H/P TUBE
CONED AND THREADED

2-way Straight

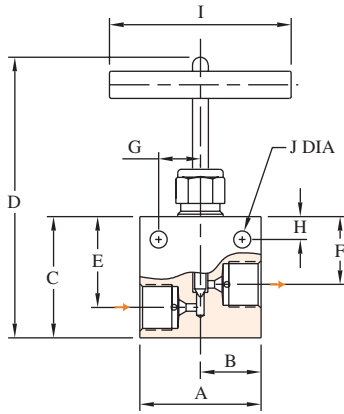

Figure 1

2-way Angle

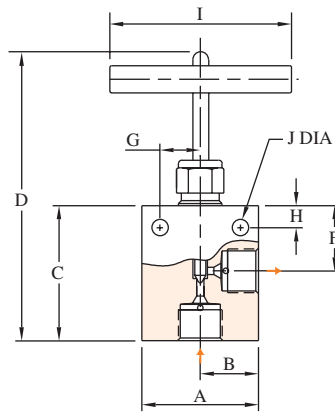

Figure 2

3-way Two on Pressure

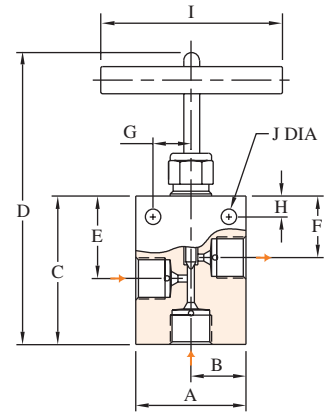

Figure 3

Catalog Number	Stem Style	A	B	C	D	E	F	G	H	I	J	K	L	Thk.	Fig
60UV41V-SOG	Vee	2.00"	1.00"	2.12"	4.90"	1.69"	1.31"	0.69"	0.38"	3.00"	0.25"	---	---	1.00"	1
60UV41R-SOG	Reg	(50.8)	(25.4)	(53.8)	(124.5)	(42.9)	(33.3)	(17.5)	(9.7)	(76.2)	(6.4)	---	---	(25.4)	
60UV42V-SOG	Vee	2.00"	1.00"	2.38"	5.16"	---	1.31"	0.69"	0.38"	3.00"	0.25"	---	---	1.00"	2
60UV42R-SOG	Reg	(50.8)	(25.4)	(60.5)	(131.1)	---	(33.3)	(17.5)	(9.7)	(76.2)	(6.4)	---	---	(25.4)	
60UV43V-SOG	Vee	2.00"	1.00"	2.38"	5.16"	1.69"	1.31"	0.69"	0.38"	3.00"	0.25"	---	---	1.00"	3
60UV43R-SOG	Reg	(50.8)	(25.4)	(60.5)	(131.1)	(42.9)	(33.3)	(17.5)	(9.7)	(76.2)	(6.4)	---	---	(25.4)	
60UV44V-SOG	Vee	2.00"	1.00"	2.38"	5.16"	1.31"	1.31"	0.69"	0.38"	3.00"	0.25"	---	---	1.00"	4
60UV44R-SOG	Reg	(50.8)	(25.4)	(60.5)	(131.1)	(33.3)	(33.3)	(17.5)	(9.7)	(76.2)	(6.4)	---	---	(25.4)	
60UV45V-SOG	Vee	2.00"	1.00"	3.44"	9.00"	1.72"	1.31"	0.69"	0.38"	3.00"	0.25"	---	---	1.00"	5
60UV45R-SOG	Reg	(50.8)	(25.4)	(87.4)	(228.6)	(43.7)	(33.3)	(17.5)	(9.7)	(76.2)	(6.4)	---	---	(25.4)	
60UV46V-SOG	Vee	2.00"	1.00"	2.62"	5.40"	---	1.31"	0.69"	0.38"	3.00"	0.25"	0.75"	1.29"	1.00"	6
60UV46R-SOG	Reg	(50.8)	(25.4)	(66.5)	(137.2)	---	(33.3)	(17.5)	(9.7)	(76.2)	(6.4)	(19.1)	(32.8)	(25.4)	

See page SOG-1 for orifice and Cv

3-way One on Pressure

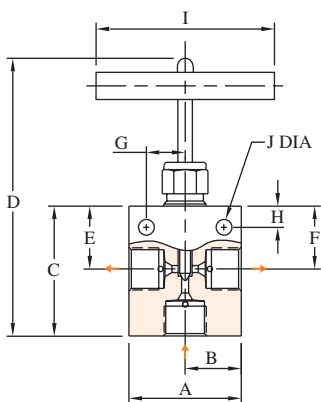

Figure 4

2-stem Manifold

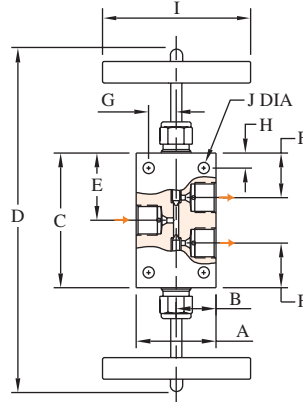

Figure 5

Replaceable Seat

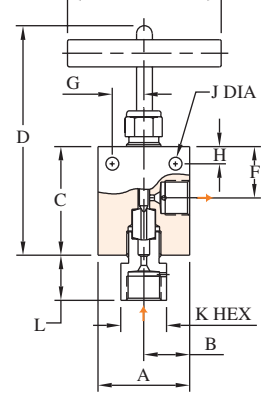

Figure 6

All dimensions are for reference only and are subject to change.
Dimensions in parentheses are millimeters (mm)



NEEDLE VALVES FOR 30,000 PSI (2070 BAR)

3/8" H/P TUBE
CONED AND THREADED

2-way Straight

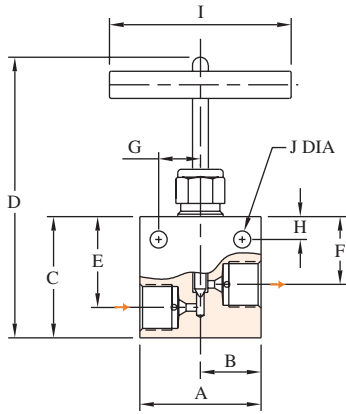

Figure 1

2-way Angle

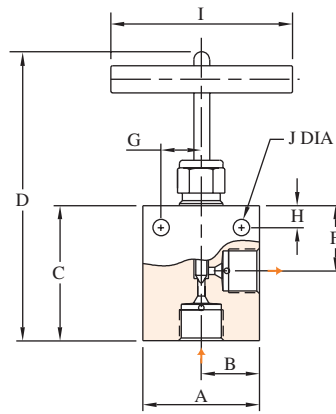

Figure 2

3-way Two on Pressure

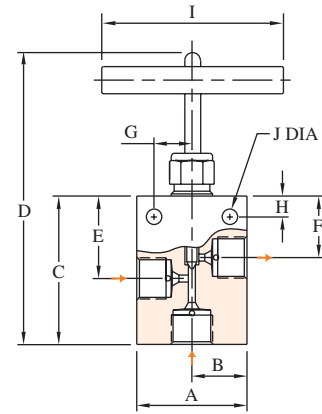

Figure 3

Catalog Number	Stem Style	A	B	C	D	E	F	G	H	I	J	K	L	Thk.	Fig
60UV61V-SOG	Vee	2.00"	1.00"	2.25"	5.03"	1.69"	1.31"	0.69"	0.38"	3.00"	0.25"	---	---	1.00"	1
60UV61R-SOG	Reg	(50.8)	(25.4)	(57.2)	(127.8)	(42.9)	(33.3)	(17.5)	(9.7)	(76.2)	(6.4)	---	---	(25.4)	
60UV62V-SOG	Vee	2.00"	1.00"	2.62"	5.40"	---	1.31"	0.69"	0.38"	3.00"	0.25"	---	---	1.00"	2
60UV62R-SOG	Reg	(50.8)	(25.4)	(66.5)	(137.2)	---	(33.3)	(17.5)	(9.7)	(76.2)	(6.4)	---	---	(25.4)	
60UV63V-SOG	Vee	2.00"	1.00"	2.75"	5.53"	1.69"	1.31"	0.69"	0.38"	3.00"	0.25"	---	---	1.00"	3
60UV63R-SOG	Reg	(50.8)	(25.4)	(69.9)	(140.5)	(42.9)	(33.3)	(17.5)	(9.7)	(76.2)	(6.4)	---	---	(25.4)	
60UV64V-SOG	Vee	2.00"	1.00"	2.62"	5.40"	1.31"	1.31"	0.69"	0.38"	3.00"	0.25"	---	---	1.00"	4
60UV64R-SOG	Reg	(50.8)	(25.4)	(66.5)	(137.2)	(33.3)	(33.3)	(17.5)	(9.7)	(76.2)	(6.4)	---	---	(25.4)	
60UV65V-SOG	Vee	2.00"	1.00"	3.75"	9.31"	1.88"	1.31"	0.69"	0.38"	3.00"	0.25"	---	---	1.00"	5
60UV65R-SOG	Reg	(50.8)	(25.4)	(95.3)	(236.5)	(47.8)	(33.3)	(17.5)	(9.7)	(76.2)	(6.4)	---	---	(25.4)	
60UV66V-SOG	Vee	2.00"	1.00"	2.62"	5.40"	---	1.31"	0.69"	0.38"	3.00"	0.25"	1.00"	1.21"	1.00"	6
60UV66R-SOG	Reg	(50.8)	(25.4)	(66.5)	(137.2)	---	(33.3)	(17.5)	(9.7)	(76.2)	(6.4)	(25.4)	(30.7)	(25.4)	

See page SOG-1 for orifice and Cv

3-way One on Pressure

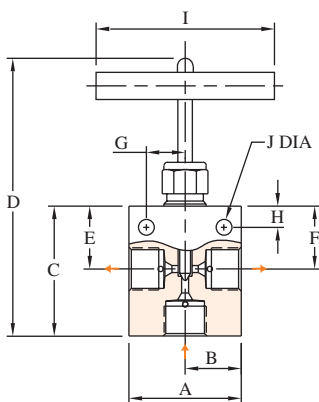

Figure 4

2-stem Manifold

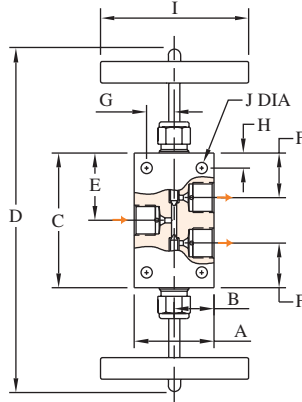

Figure 5

Replaceable Seat

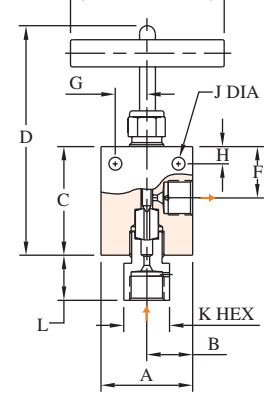

Figure 6

All dimensions are for reference only and are subject to change.
Dimensions in parentheses are millimeters (mm)

NEEDLE VALVES FOR 30,000 PSI (2070 BAR)

9/16" H/P TUBE
CONED AND THREADED

2-way Straight

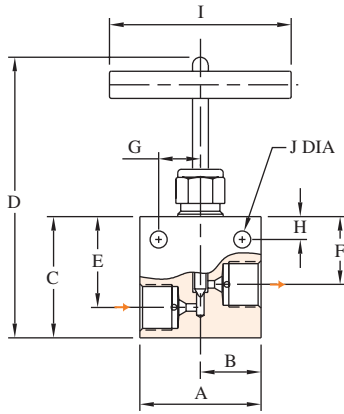

Figure 1

2-way Angle

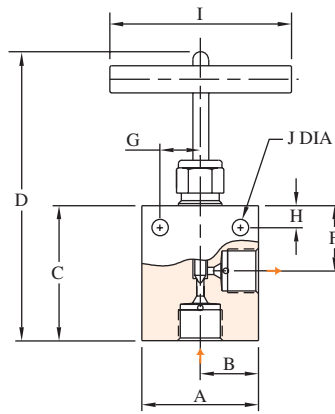

Figure 2

3-way Two on Pressure

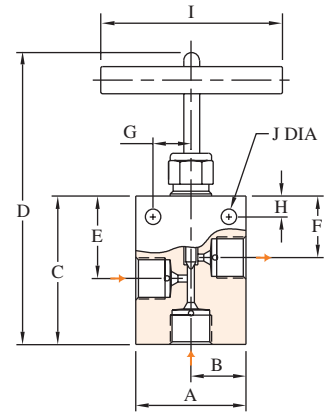

Figure 3

Catalog Number	Stem Style	A	B	C	D	E	F	G	H	I	J	K	L	Thk.	Fig
60UV91V-SOG	Vee	2.62"	1.31"	2.50"	5.28"	1.69"	1.31"	0.69"	0.38"	3.00"	0.28"	---	---	1.50"	1
60UV91R-SOG	Reg	(66.5)	(33.3)	(63.5)	(134.1)	(42.9)	(33.3)	(17.5)	(9.7)	(76.2)	(7.1)	---	---	(38.1)	
60UV92V-SOG	Vee	2.62"	1.31"	2.81"	5.59"	---	1.31"	0.69"	0.38"	3.00"	0.28"	---	---	1.50"	2
60UV92R-SOG	Reg	(66.5)	(33.3)	(71.4)	(142.0)	---	(33.3)	(17.5)	(9.7)	(76.2)	(7.1)	---	---	(38.1)	
60UV93V-SOG	Vee	2.62"	1.31"	3.03"	5.81"	1.75"	1.31"	0.69"	0.38"	3.00"	0.28"	---	---	1.50"	3
60UV93R-SOG	Reg	(66.5)	(33.3)	(77.0)	(147.6)	(44.5)	(33.3)	(17.5)	(9.7)	(76.2)	(7.1)	---	---	(38.1)	
60UV94V-SOG	Vee	2.62"	1.31"	2.81"	5.59"	1.31"	1.31"	0.69"	0.38"	3.00"	0.28"	---	---	1.50"	4
60UV94R-SOG	Reg	(66.5)	(33.3)	(71.4)	(142.0)	(33.3)	(33.3)	(17.5)	(9.7)	(76.2)	(7.1)	---	---	(38.1)	
60UV95V-SOG	Vee	2.62"	1.31"	4.12"	9.68"	2.06"	1.31"	0.69"	0.50"	3.00"	0.28"	---	---	1.50"	5
60UV95R-SOG	Reg	(66.5)	(33.3)	(104.6)	(245.9)	(52.3)	(33.3)	(17.5)	(12.7)	(76.2)	(7.1)	---	---	(38.1)	
60UV96V-SOG	Vee	2.62"	1.31"	2.62"	5.40"	---	1.31"	0.69"	0.38"	3.00"	0.28"	1.38"	1.39"	1.50"	6
60UV96R-SOG	Reg	(66.5)	(33.3)	(66.5)	(137.2)	---	(33.3)	(17.5)	(9.7)	(76.2)	(7.1)	(35.1)	(35.3)	(38.1)	

See page SOG-1 for orifice and Cv

3-way One on Pressure

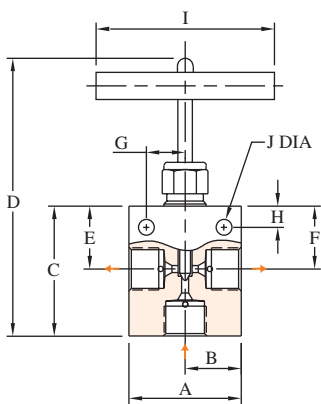

Figure 4

2-stem Manifold

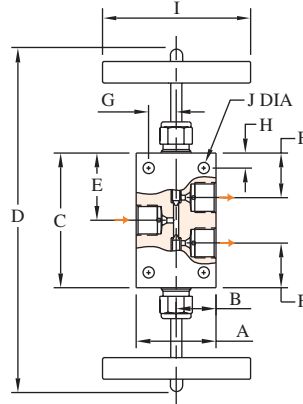

Figure 5

Replaceable Seat

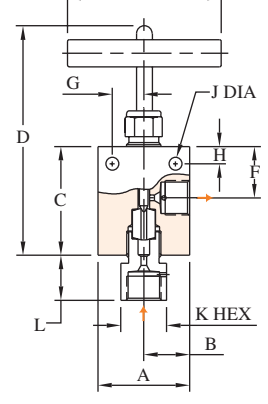
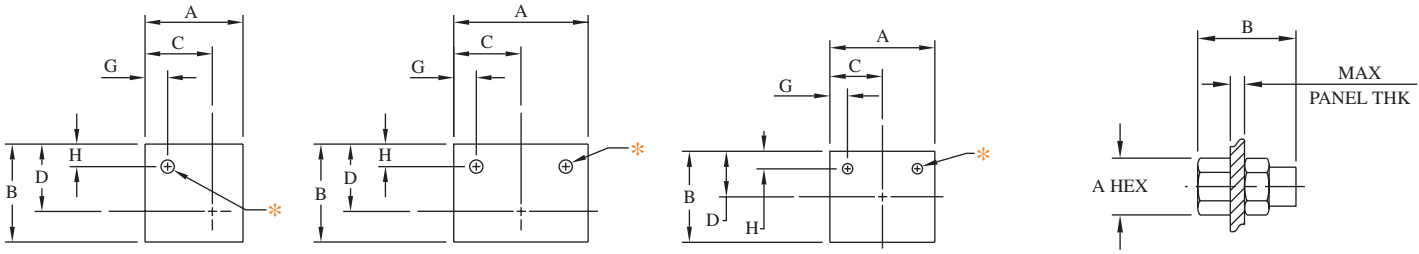

Figure 6

All dimensions are for reference only and are subject to change.
Dimensions in parentheses are millimeters (mm)



SOUR GAS EQUIPMENT



ELBOWS

Catalog				Block					Mounting Holes*		
Number	Connection	Port	MAWP	A	B	C	D	Thickness	G	H	Dia.
60L4-SOG	1/4" H/P Tube	0.093" (2.4)	30,000 PSI 2070 bar	1.50" (38.1)	1.00" (25.4)	0.88" (22.4)	0.63" (16.0)	0.75" (19.1)	0.25" (6.4)	0.15" (3.8)	0.22" (5.6)
60L6-SOG	3/8" H/P Tube	0.125" (3.2)	30,000 PSI 2070 bar	2.00" (50.8)	1.50" (38.1)	1.25" (31.8)	1.00" (25.4)	1.00" (25.4)	0.38" (9.7)	0.31" (7.9)	0.22" (5.6)
60L9-SOG	9/16" H/P Tube	0.187" (4.7)	30,000 PSI 2070 bar	2.62" (66.5)	1.88" (47.8)	1.88" (47.8)	1.13" (28.6)	1.50" (38.1)	2.32" (58.9)	1.38" (35.1)	0.28" (7.1)

TEES

Catalog				Block					Mounting Holes*		
Number	Connection	Port	MAWP	A	B	C	D	Thickness	G	H	Dia.
60T4-SOG	1/4" H/P Tube	0.093" (2.4)	30,000 PSI 2070 bar	2.00" (50.8)	1.25" (31.8)	1.00" (25.4)	0.88" (22.4)	1.00" (25.4)	0.25" (6.4)	0.12" (3.0)	0.17" (4.3)
60T6-SOG	3/8" H/P Tube	0.125" (3.2)	30,000 PSI 2070 bar	2.00" (50.8)	1.56" (39.6)	1.00" (25.4)	1.06" (26.9)	1.00" (25.4)	0.31" (7.9)	0.31" (7.9)	0.22" (5.6)
60T9-SOG	9/16" H/P Tube	0.187" (4.7)	30,000 PSI 2070 bar	2.62" (66.5)	2.12" (53.8)	1.31" (33.3)	1.38" (35.1)	1.50" (38.1)	0.37" (9.4)	0.38" (9.5)	0.28" (7.1)

CROSSES

Catalog				Block					Mounting Holes*		
Number	Connection	Port	MAWP	A	B	C	D	Thickness	G	H	Dia.
60X4-SOG	1/4" H/P Tube	0.093" (2.4)	30,000 PSI 2070 bar	2.00" (50.8)	1.25" (31.8)	1.00" (25.4)	0.62" (15.7)	1.00" (25.4)	0.25" (6.4)	0.12" (3.0)	0.17" (4.3)
60X6-SOG	3/8" H/P Tube	0.125" (3.2)	30,000 PSI 2070 bar	2.00" (50.8)	2.12" (53.8)	1.00" (25.4)	1.06" (26.9)	1.00" (25.4)	0.31" (7.9)	0.31" (7.9)	0.22" (5.6)
60X9-SOG	9/16" H/P Tube	0.187" (4.7)	30,000 PSI 2070 bar	2.62" (66.5)	2.75" (69.9)	1.31" (33.3)	1.38" (35.1)	1.50" (38.1)	0.38" (9.7)	0.38" (9.5)	0.28" (7.1)

BULKHEADS

Catalog				Max Panel			Panel
Number	Connection	Port	MAWP	A	B	Thickness	Hole
60BF4-SOG	1/4" H/P Tube	0.093" (2.4)	30,000 PSI 2070 bar	1.00" (25.4)	2.00" (50.8)	0.50" (12.7)	0.81" (20.6)
60BF6-SOG	3/8" H/P Tube	0.125" (3.2)	30,000 PSI 2070 bar	1.38" (35.1)	2.38" (60.5)	0.38" (9.7)	1.12" (28.4)
60BF9-SOG	9/16" H/P Tube	0.187" (4.7)	30,000 PSI 2070 bar	1.87" (47.5)	2.75" (69.9)	0.62" (15.7)	1.75" (44.5)

*Mounting holes provided when the catalog number is suffixed by "-MH" when ordering.

All dimensions are for reference only and are subject to change.
Dimensions in parentheses are millimeters (mm)



SOUR GAS COUPLINGS

COUPLINGS, H/P TUBE TO H/P TUBE

Catalog Number	Female H/P	Female H/P	Port	MAWP	A	B
60F4-SOG	1/4"	1/4"	0.093" (2.4)	30,000 PSI 2070 bar	0.75" (19.1)	1.38" (35.1)
60F4H6H-SOG	1/4"	3/8"	0.093" (2.4)	30,000 PSI 2070 bar	1.00" (25.4)	1.75" (44.5)
60F4H9H-SOG	1/4"	9/16"	0.093" (2.4)	30,000 PSI 2070 bar	1.38" (35.1)	2.25" (57.2)
60F6-SOG	3/8"	3/8"	0.125" (3.2)	30,000 PSI 2070 bar	1.00" (25.4)	1.75" (44.5)
60F6H9H-SOG	3/8"	9/16"	0.125" (3.2)	30,000 PSI 2070 bar	1.38" (35.1)	2.25" (57.2)
60F9-SOG	9/16"	9/16"	0.187" (4.7)	30,000 PSI 2070 bar	1.38" (35.1)	2.25" (57.2)

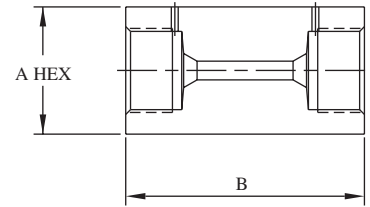

COUPLINGS, H/P TUBE TO PIPE

Catalog Number	Female H/P	Female NPT	Port	MAWP	A	B
10F4H2P-SOG	1/4"	1/8"	0.093" (2.4)	10,000 PSI 690 bar	0.75" (19.1)	1.50" (38.1)
10F4H4P-SOG	1/4"	1/4"	0.093" (2.4)	10,000 PSI 690 bar	0.75" (19.1)	1.50" (38.1)
10F4H6P-SOG	1/4"	3/8"	0.093" (2.4)	10,000 PSI 690 bar	1.00" (25.4)	1.62" (41.1)
10F4H8P-SOG	1/4"	1/2"	0.093" (2.4)	10,000 PSI 690 bar	1.38" (35.1)	2.12" (53.8)
10F6H2P-SOG	3/8"	1/8"	0.125" (3.2)	10,000 PSI 690 bar	1.00" (25.4)	1.75" (44.5)
10F6H4P-SOG	3/8"	1/4"	0.125" (3.2)	10,000 PSI 690 bar	1.00" (25.4)	1.75" (44.5)
10F6H6P-SOG	3/8"	3/8"	0.125" (3.2)	10,000 PSI 690 bar	1.00" (25.4)	1.75" (44.5)
10F6H8P-SOG	3/8"	1/2"	0.125" (3.2)	10,000 PSI 690 bar	1.38" (35.1)	2.12" (53.8)
10F9H2P-SOG	9/16"	1/8"	0.187" (4.7)	10,000 PSI 690 bar	1.38" (35.1)	2.25" (57.2)
10F9H4P-SOG	9/16"	1/4"	0.187" (4.7)	10,000 PSI 690 bar	1.38" (35.1)	2.25" (57.2)
10F9H6P-SOG	9/16"	3/8"	0.187" (4.7)	10,000 PSI 690 bar	1.38" (35.1)	2.25" (57.2)
10F9H8P-SOG	9/16"	1/2"	0.187" (4.7)	10,000 PSI 690 bar	1.38" (35.1)	2.25" (57.2)

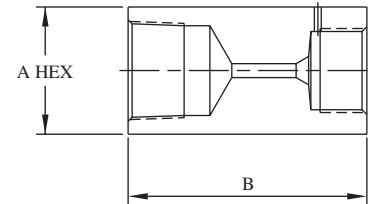

REPLACEABLE SEAT COUPLINGS

Catalog Number	Connection	Port	MAWP	A	B
60UF4-SOG	1/4" H/P Tube	0.093" (2.4)	30,000 PSI 2070 bar	0.75" (19.1)	1.50" (38.1)
60UF6-SOG	3/8" H/P Tube	0.125" (3.2)	30,000 PSI 2070 bar	1.38" (35.1)	1.75" (44.5)
60UF9-SOG	9/16" H/P Tube	0.187" (4.7)	30,000 PSI 2070 bar	1.38" (35.1)	2.25" (57.2)

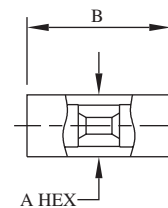

All dimensions are for reference only and are subject to change.
Dimensions in parentheses are millimeters (mm)

Page SOG-11

ButTech
MILTON ROY

2121 EBCO Drive, Suite 1 • Erie, PA 16506 USA • Ph: (814) 833-4904 • Fax: (814) 833-2612 • E-mail: hq@butech-valve.com



SOUR GAS ADAPTERS

H/P Male X NPT Female

Catalog Number	Male H/P	Female NPT	Port	MAWP	A	B
10A4H2P-SOG	1/4"	1/8"	0.125" (3.2)	10,000 PSI 690 bar	0.63" (16.0)	1.43" (36.3)
10A4H4P-SOG	1/4"	1/4"	0.125" (3.2)	10,000 PSI 690 bar	0.75" (19.1)	1.68" (42.7)
10A4H6P-SOG	1/4"	3/8"	0.125" (3.2)	10,000 PSI 690 bar	1.00" (25.4)	1.68" (42.7)
10A4H8P-SOG	1/4"	1/2"	0.125" (3.2)	10,000 PSI 690 bar	1.38" (35.1)	1.93" (49.0)
10A6H2P-SOG	3/8"	1/8"	0.218" (5.5)	10,000 PSI 690 bar	0.75" (19.1)	1.75" (44.5)
10A6H4P-SOG	3/8"	1/4"	0.218" (5.5)	10,000 PSI 690 bar	1.00" (25.4)	2.00" (50.8)
10A6H6P-SOG	3/8"	3/8"	0.218" (5.5)	10,000 PSI 690 bar	1.00" (25.4)	2.00" (50.8)
10A6H8P-SOG	3/8"	1/2"	0.218" (5.5)	10,000 PSI 690 bar	1.38" (35.1)	2.38" (60.5)
10A9H2P-SOG	9/16"	1/8"	0.281" (7.1)	10,000 PSI 690 bar	1.18" (30.0)	2.06" (52.3)
10A9H4P-SOG	9/16"	1/4"	0.281" (7.1)	10,000 PSI 690 bar	1.18" (30.0)	2.06" (52.3)
10A9H6P-SOG	9/16"	3/8"	0.281" (7.1)	10,000 PSI 690 bar	1.18" (30.0)	2.06" (52.3)
10A9H8P-SOG	9/16"	1/2"	0.281" (7.1)	10,000 PSI 690 bar	1.38" (35.1)	2.06" (52.3)
10A9H12P-SOG	9/16"	3/4"	0.281" (7.1)	10,000 PSI 690 bar	1.75" (44.5)	2.69" (68.3)

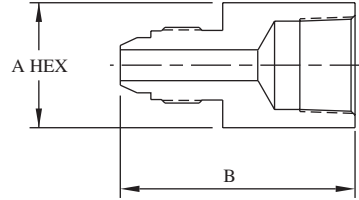

NPT Male X H/P Female

Catalog Number	Male NPT	Female H/P	Port	MAWP	A	B
10A2P4H-SOG	1/8"	1/4"	0.093" (2.4)	10,000 PSI 690 bar	0.75" (19.1)	1.50" (38.1)
10A2P6H-SOG	1/8"	3/8"	0.125" (3.2)	10,000 PSI 690 bar	1.00" (25.4)	1.75" (44.5)
10A2P9H-SOG	1/8"	9/16"	0.187" (4.7)	10,000 PSI 690 bar	1.38" (35.1)	2.25" (57.2)
10A4P4H-SOG	1/4"	1/4"	0.093" (2.4)	10,000 PSI 690 bar	0.75" (19.1)	1.50" (38.1)
10A4P6H-SOG	1/4"	3/8"	0.125" (3.2)	10,000 PSI 690 bar	1.00" (25.4)	1.75" (44.5)
10A4P9H-SOG	1/4"	9/16"	0.187" (4.7)	10,000 PSI 690 bar	1.38" (35.1)	2.25" (57.2)
10A6P4H-SOG	3/8"	1/4"	0.093" (2.4)	10,000 PSI 690 bar	0.75" (19.1)	1.50" (38.1)
10A6P6H-SOG	3/8"	3/8"	0.125" (3.2)	10,000 PSI 690 bar	1.00" (25.4)	1.75" (44.5)
10A6P9H-SOG	3/8"	9/16"	0.187" (4.7)	10,000 PSI 690 bar	1.38" (35.1)	2.25" (57.2)
10A8P4H-SOG	1/2"	1/4"	0.093" (2.4)	10,000 PSI 690 bar	1.00" (25.4)	1.62" (41.1)
10A8P6H-SOG	1/2"	3/8"	0.125" (3.2)	10,000 PSI 690 bar	1.00" (25.4)	1.75" (44.5)
10A8P9H-SOG	1/2"	9/16"	0.187" (4.7)	10,000 PSI 690 bar	1.38" (35.1)	2.25" (57.2)
10A12P9H-SOG	3/4"	9/16"	0.187" (4.7)	10,000 PSI 690 bar	1.38" (35.1)	2.25" (57.2)
10A16P4H-SOG	1"	1/4"	0.093" (2.4)	10,000 PSI 690 bar	1.38" (35.1)	1.75" (44.5)

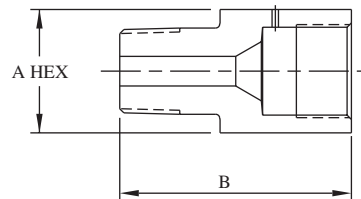

All dimensions are for reference only and are subject to change.
Dimensions in parentheses are millimeters (mm)

SOUR GAS ADAPTERS

H/P Male X H/P Female

Catalog Number	Male H/P	Female H/P	Port	MAWP	A	B
60A4H4H-SOG	1/4"	1/4"	0.093" (2.4)	30,000 PSI 2070 bar	0.75" (19.1)	1.43" (36.3)
60A4H6H-SOG	1/4"	3/8"	0.125" (3.2)	30,000 PSI 2070 bar	1.00" (25.4)	1.93" (49.0)
60A4H9H-SOG	1/4"	9/16"	0.125" (3.2)	30,000 PSI 2070 bar	1.38" (35.1)	2.43" (61.7)
60A6H4H-SOG	3/8"	1/4"	0.093" (2.4)	30,000 PSI 2070 bar	0.75" (19.1)	1.75" (44.5)
60A6H9H-SOG	3/8"	9/16"	0.188" (4.8)	30,000 PSI 2070 bar	1.38" (35.1)	2.50" (63.5)
60A9H4H-SOG	9/16"	1/4"	0.093" (2.4)	30,000 PSI 2070 bar	1.18" (30.0)	2.06" (52.3)
60A9H6H-SOG	9/16"	3/8"	0.125" (3.2)	30,000 PSI 2070 bar	1.18" (30.0)	2.06" (52.3)
60A9H9H-SOG	9/16"	9/16"	0.188" (4.8)	30,000 PSI 2070 bar	1.38" (35.1)	2.56" (65.0)

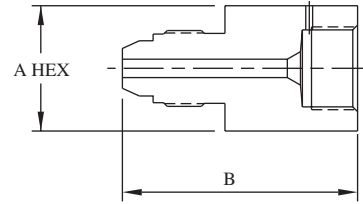

H/P Male X H/P Male

Catalog Number	Male H/P	Male H/P	Port	MAWP	A	B
MA4H4H-SOG	1/4"	1/4"	0.125" (3.2)	30,000 PSI 2070 bar	0.75" (19.1)	2.12" (53.8)
MA6H4H-SOG	3/8"	1/4"	0.082" (2.1)	30,000 PSI 2070 bar	0.75" (19.1)	2.42" (61.5)
MA6H6H-SOG	3/8"	3/8"	0.218" (5.5)	30,000 PSI 2070 bar	0.75" (19.1)	2.50" (63.5)
MA9H4H-SOG	9/16"	1/4"	0.125" (3.2)	30,000 PSI 2070 bar	1.13" (28.7)	2.99" (75.9)
MA9H6H-SOG	9/16"	3/8"	0.218" (5.5)	30,000 PSI 2070 bar	1.18" (30.0)	3.06" (77.7)
MA9H9H-SOG	9/16"	9/16"	0.218" (5.5)	30,000 PSI 2070 bar	1.18" (30.0)	3.37" (85.6)

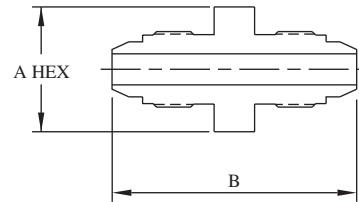

H/P Male X NPT Male

Catalog Number	Male H/P	Male NPT	Port	MAWP	A	B
MA4H2P-SOG	1/4"	1/8"	0.125" (3.2)	10,000 PSI 690 bar	1.00" (25.4)	2.18" (55.4)
MA4H4P-SOG	1/4"	1/4"	0.125" (3.2)	10,000 PSI 690 bar	1.00" (25.4)	2.18" (55.4)
MA4H6P-SOG	1/4"	3/8"	0.125" (3.2)	10,000 PSI 690 bar	0.75" (19.1)	1.86" (47.2)
MA4H8P-SOG	1/4"	1/2"	0.125" (3.2)	10,000 PSI 690 bar	1.00" (25.4)	2.18" (55.4)
MA6H2P-SOG	3/8"	1/8"	0.218" (5.5)	10,000 PSI 690 bar	1.38" (35.1)	2.75" (69.9)
MA6H4P-SOG	3/8"	1/4"	0.218" (5.5)	10,000 PSI 690 bar	1.00" (25.4)	2.75" (69.9)
MA6H6P-SOG	3/8"	3/8"	0.218" (5.5)	10,000 PSI 690 bar	0.81" (20.6)	2.19" (55.6)
MA6H8P-SOG	3/8"	1/2"	0.125" (3.2)	10,000 PSI 690 bar	1.00" (25.4)	3.00" (76.2)
MA9H2P-SOG	9/16"	1/8"	0.281" (7.1)	10,000 PSI 690 bar	1.13" (28.7)	2.81" (71.4)
MA9H4P-SOG	9/16"	1/4"	0.250" (6.4)	10,000 PSI 690 bar	1.13" (28.7)	2.81" (71.4)
MA9H6P-SOG	9/16"	3/8"	0.281" (7.1)	10,000 PSI 690 bar	1.13" (28.7)	2.81" (71.4)
MA9H8P-SOG	9/16"	1/2"	0.188" (4.8)	10,000 PSI 690 bar	1.18" (30.0)	3.00" (76.2)
MA9H12P-SOG	9/16"	3/4"	0.281" (7.1)	10,000 PSI 690 bar	1.13" (28.7)	2.63" (66.8)

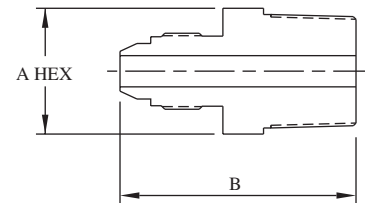

All dimensions are for reference only and are subject to change.
Dimensions in parentheses are millimeters (mm)

SOUR GAS NIPPLES AND TUBING

Coned and Threaded Nipples

BuTech stocks pre-cut coned and threaded nipples in lengths up to 12" (305 mm). In addition, nipples can be purchased to any custom length.

All nipples are 316 stainless steel, annealed in compliance with NACE MR-01-75.

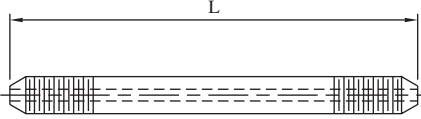

Connection	Length							MAWP
	2.75" (69.9)	3.00" (76.2)	4.00" (101.6)	6.00" (152.4)	8.00" (203.2)	10.00" (254.0)	12.00" (304.8)	
1/4" H/P	60N442-SOG	60N443-SOG	60N444-SOG	60N446-SOG	60N448-SOG	60N4410-SOG	60N4412-SOG	30,000 PSI 2070 bar
3/8" H/P		60N663-SOG	60N664-SOG	60N666-SOG	60N668-SOG	60N6610-SOG	60N6612-SOG	30,000 PSI 2070 bar
9/16" H/P			60N994-SOG	60N996-SOG	60N998-SOG	60N9910-SOG	60N9912-SOG	30,000 PSI 2070 bar

Tubing

Catalog Number	Connection	O.D.	I.D.	MAWP
60-083-316-SOG	1/4" H/P	0.250" (6.4)	0.083" (2.1)	30,000 PSI 2070 bar
60-125-316-SOG	3/8" H/P	0.375" (9.5)	0.125" (3.2)	30,000 PSI 2070 bar
60-188-316-SOG	9/16" H/P	0.562" (14.3)	0.188" (4.8)	30,000 PSI 2070 bar

BuTech offers a complete selection of austenitic seamless annealed stainless steel tubing for high pressure applications where both high strength and corrosion resistance are desired. Tubing is available in standard 20-24 foot lengths (6-7 meters), however, longer lengths are available on request.

All tubing is 316 stainless steel, annealed in compliance with NACE MR-01-75.



See Section T for Coning Tools, Threading Tools and Tube Vises!

SOUR GAS CONNECTION COMPONENTS

Connection Components

All BuTech valves and fittings for Sour Gas Service are supplied without glands and collars. To order these components separately, use catalog numbers listed below. When using a plug, the collar is not required.

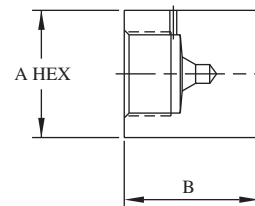

Tube Size	Collar	Gland	Plug
1/4" H/P	60C4-SOG	60G4-SOG	60P4-SOG
3/8" H/P	60C6-SOG	60G6-SOG	60P6-SOG
9/16" H/P	60C9-SOG	60G9-SOG	60P9-SOG

Cap	A	B	C	D
60CA4-SOG	0.75" (19.1)	1.06" (26.9)	0.63" (16.0)	0.60" (15.2)
60CA6-SOG	1.00" (25.4)	1.25" (31.8)	0.81" (20.6)	0.72" (18.3)
60CA9-SOG	1.38" (35.1)	1.62" (41.1)	1.18" (30.0)	0.96" (24.4)

Anti-Vibration Collet Glands

In standard high pressure connection systems, the bending stresses imposed by excessive vibration or shock on the the threaded area of the tubing may cause premature fatigue failure at the back of the thread. By using a BuTech Anti-Vibration Collet Gland, the stress concentration is transferred back to the unthreaded section of the tubing. This transfer and the spring-type gripping action of the collet, strengthens the entire assembly, resulting in virtually unlimited vibration fatigue life. Anti-Vibration Collet Glands are recommended whenever locating a valve or fitting on an unsupported line near a compressor, on equipment subjected to road vibrations, or areas where extreme shock is present.

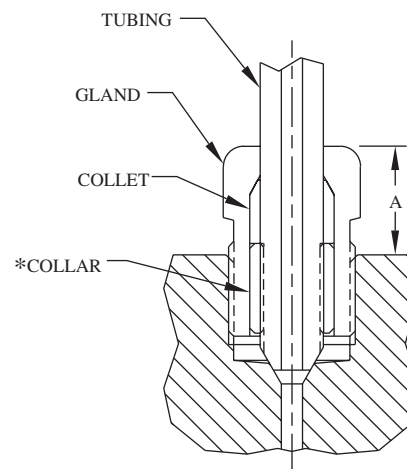

Connection	Catalog Number	Gland Hex Size	Height 'A'	Collar*
1/4" H/P	60AVG4-SOG	0.62" (15.7)	0.50" (12.7)	60C4
3/8" H/P	60AVG6-SOG	0.81" (20.6)	0.75" (19.1)	60C6
9/16" H/P	60AVG9-SOG	1.18" (30.0)	0.94" (23.9)	60C9

Anti-vibration glands are manufactured of 316 stainless steel and are available with an optional bonded dry-film Moly lubricant (add suffix **-MC** to catalog number)

*Collars are not included with anti-vibration assembly and must be ordered separately.



All dimensions are for reference only and are subject to change.
Dimensions in parentheses are millimeters (mm)

SOUR GAS CHECK VALVES

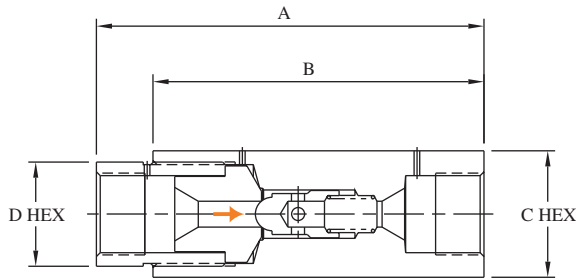

BuTech ball check valves prevent reverse flow where leak-tight shutoff is not necessary. Standard materials of construction are 316 stainless steel with 17-4PH poppet for longer life, and 300 series stainless steel spring.

Note: For 316 stainless steel wetted parts, add **-316WP** to the catalog number.

Cracking pressure: 15 PSI (1 bar) approximate
Operating Temperature Range:

-420° to +1200°F
(-251° to +648°C)

BALL CHECK VALVES

Catalog Number	Connection	MAWP	Cv	A	B	C	D
60BC4-SOG	1/4" H/P Tube	30,000 PSI 2070 bar	0.15	3.31" (84.1)	2.50" (63.5)	1.12" (28.4)	0.88" (22.4)
60BC6-SOG	3/8" H/P Tube	30,000 PSI 2070 bar	0.28	3.75" (95.3)	3.00" (76.2)	1.38" (35.1)	1.12" (28.4)
60BC9-SOG	9/16" H/P Tube	30,000 PSI 2070 bar	0.63	4.57" (116.1)	3.38" (85.9)	1.50" (38.1)	1.38" (35.1)

To order a valve with a cracking pressure other than the standard 15 PSI, add the cracking pressure to the end of the catalog number. Example: A 60BC9-SOG with 50 PSI cracking pressure would be ordered as **60BC9-SOG-50**.

Cracking pressures available up to 100 PSI (7 bar)

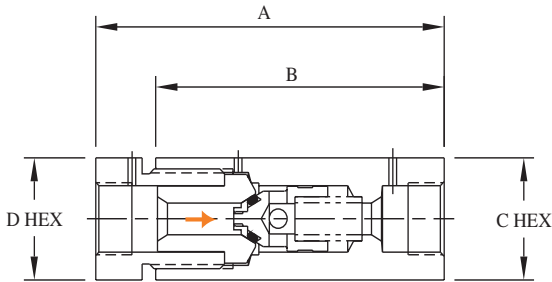

BuTech o-ring check valves reliably prevent backflow where leak-tight shutoff for liquids or gases is required. Standard materials of construction are 316 stainless steel with Buna-N o-ring and 300 series stainless steel spring.

Cracking pressure: 15 PSI (1 bar) approximate
Operating Temperature Ranges:

O-ring Material	Operating Temperature Range	Catalog Suffix
Buna-N	-65° to +250°F (-54° to +121°C)	----
Viton	-40° to +500°F (-40° to +260°C)	-VA
Teflon	-320° to +400°F (-195° to +204°C)	-TFE
Kalrez	-20° to +550°F (-29° to +288°C)	-HT

O-RING CHECK VALVES

Catalog Number	Connection	MAWP	Cv	A	B	C	D
60SC4-SOG	1/4" H/P Tube	30,000 PSI 2070 bar	0.15	3.31" (84.1)	2.50" (63.5)	1.12" (28.4)	0.88" (22.4)
60SC6-SOG	3/8" H/P Tube	30,000 PSI 2070 bar	0.28	3.75" (95.3)	3.00" (76.2)	1.38" (35.1)	1.12" (28.4)
60SC9-SOG	9/16" H/P Tube	30,000 PSI 2070 bar	0.63	4.57" (116.1)	3.38" (85.9)	1.50" (38.1)	1.38" (35.1)

To order a valve with a cracking pressure other than the standard 15 PSI, add the cracking pressure to the end of the catalog number. Example: A 60SC4-SOG with 40 PSI cracking pressure would be ordered as **60SC4-SOG-40**.

Cracking pressures available up to 100 PSI (7 bar)

All dimensions are for reference only and are subject to change.
Dimensions in parentheses are millimeters (mm)

SOUR GAS FILTERS

BuTech line filters are used in system lines to remove contaminating particles from the system fluid. Upstream filter of larger micron rating than downstream filter to prevent clogging of downstream filter.

Standard materials of construction are 316 stainless steel with 300 series stainless steel filter discs. Available in nominal ratings of: 0.5, 2, 5, 10, 20, 40, and 100 micron.

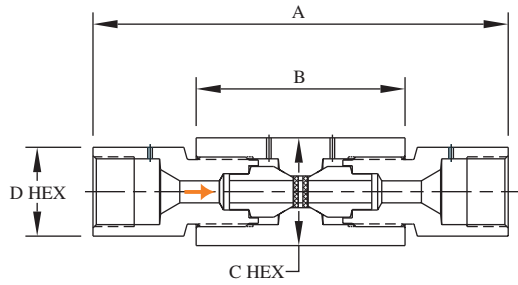

LINE FILTERS

Catalog Number	Connection	MAWP	Area*	A	B	C	D
60LF4-SOG	1/4" H/P Tube	30,000 PSI 2070 bar	0.15 in ² 97 mm ²	4.06" (103.1)	2.62" (66.5)	1.38" (35.1)	0.88" (22.4)
60LF6-SOG	3/8" H/P Tube	30,000 PSI 2070 bar	0.15 in ² 97 mm ²	4.56" (115.8)	2.62" (66.5)	1.38" (35.1)	1.00" (25.4)
60LF9-SOG	9/16" H/P Tube	30,000 PSI 2070 bar	0.15 in ² 97 mm ²	6.00" (152.4)	3.62" (91.9)	1.50" (38.1)	1.38" (35.1)

*Effective area of filter element

Micron rating of filter must be specified. To order, complete the catalog number with the desired micron rating, upstream first:

60LF4-SOG-40/20

specifies a line filter with 1/4" H/P connections, a 40 micron filter upstream and 20 micron downstream.

BuTech sintered cup filters offer maximum filtration surface area for removal of contaminating particles from the fluid system. They may be used in systems which require high flow rates with minimum pressure drop.

Standard materials of construction are 316 stainless steel with 300 series stainless steel filter discs. Available in nominal ratings of: 5, 10, 20, 40, and 100 micron.

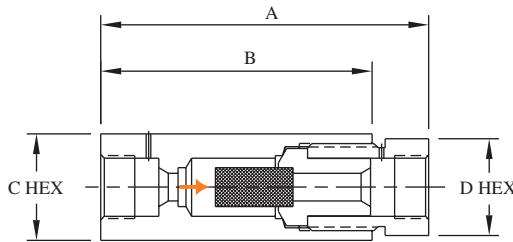

SINTERED CUP FILTERS

Catalog Number	Connection	MAWP	Area*	A	B	C	D
60SCF4-SOG	1/4" H/P Tube	30,000 PSI 2070 bar	0.44 in ² 284 mm ²	3.32" (84.3)	2.50" (63.5)	1.12" (28.4)	0.88" (22.4)
60SCF6-SOG	3/8" H/P Tube	30,000 PSI 2070 bar	0.54 in ² 348 mm ²	3.75" (95.3)	3.00" (76.2)	1.38" (35.1)	1.12" (28.4)
60SCF9-SOG	9/16" H/P Tube	30,000 PSI 2070 bar	0.86 in ² 555 mm ²	4.70" (119.4)	3.37" (85.6)	1.50" (38.1)	1.38" (35.1)

*Effective area of filter element

Micron rating of filter must be specified. To order, complete the catalog number with the desired micron rating:

60SCF4-SOG-20

specifies a line filter with 1/4" H/P connections and a 20 micron filter.

All dimensions are for reference only and are subject to change.
Dimensions in parentheses are millimeters (mm)

Page SOG-17



SOUR GAS SAFETY HEADS & RUPTURE DISCS

BuTech safety head assemblies serve as holders for standard rupture discs (sold separately). Safety heads with rupture discs are used as simple and inexpensive overpressure relief devices. System pressure is relieved as a result of rupture of the replaceable disc.

The safety head assemblies shown are designed for use in high pressure systems up to 20,000 PSI (1380 bar). They can be installed directly into any of our standard couplings, elbows, tees, or crosses. Their versatility also allows direct installation into a standard 3-way valve. The result is a combination valve/safety head with beneficial cost and space advantages.

Standard material of construction is 316 stainless steel.

Safety head assemblies and rupture discs are available in two styles:

The **1/4A** style features a 1/4" blow-out diameter, an angular seat and can be ordered in pressures from 900 to 60,000 PSI (62 to 4140 bar)

The **1/2F** style features a 1/2" blow-out diameter, a flat seat and can be ordered in pressures from 500 to 10,000 PSI (34 to 689 bar). This style also has a reversible hold-down ring which greatly reduces the possibility of premature disc failure associated with installation errors inherent in some designs.

Rupture discs are available in a wide range of burst ratings. Factors such as corrosion, fatigue and temperature may affect the burst pressure of the disc and cause premature failure. This problem may sometimes be overcome by frequent replacement of the disc. All discs rated over 500 PSI (34 bar) have a manufacturing tolerance of 3% under to 6% over the specified rupture pressure rating.

Rupture Discs are not included in the safety head assembly. To order discs separately, use the following part numbering system:

<u>Style</u>	<u>Material</u>	<u>Pressure:</u>
4=1/4" Angled 8=1/2" Flat	IN=Inconel	List desired pressure at 72°F (21°C) in KSI.

Examples:

An Inconel disc rated for 18,000 PSI in 1/4" Angled style would be ordered as **4IN18.00**

An Inconel disc rated for 750 PSI in 1/2" Flat style would be ordered as **8IN0.750**

SAFETY HEADS - 1/4" ANGLED DISC

Catalog Number	Connection	MAWP	A	B	C	Discharge
60SH4-1/4A-SOG	1/4" H/P Tube	30,000 PSI 2070 bar	1.00" (25.4)	2.75" (69.9)	1.00" (25.4)	3/8" FNPT
60SH6-1/4A-SOG	3/8" H/P Tube	30,000 PSI 2070 bar	1.00" (25.4)	2.81" (71.4)	1.00" (25.4)	3/8" FNPT
60SH9-1/4A-SOG	9/16" H/P Tube	30,000 PSI 2070 bar	1.38" (35.1)	2.88" (73.0)	1.00" (25.4)	3/8" FNPT

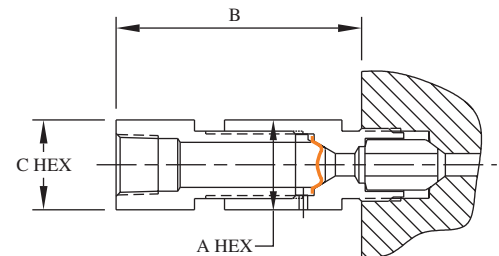

SAFETY HEADS - 1/2" FLAT DISC

Catalog Number	Connection	MAWP	A	B	C	Discharge
60SH4-1/2F-SOG	1/4" H/P Tube	10,000 PSI 689 bar	1.00" (25.4)	2.68" (68.1)	1.00" (25.4)	3/8" FNPT
60SH6-1/2F-SOG	3/8" H/P Tube	10,000 PSI 689 bar	1.00" (25.4)	2.81" (71.4)	1.00" (25.4)	3/8" FNPT
60SH9-1/2F-SOG	9/16" H/P Tube	10,000 PSI 689 bar	1.38" (35.1)	2.81" (71.4)	1.00" (25.4)	3/8" FNPT

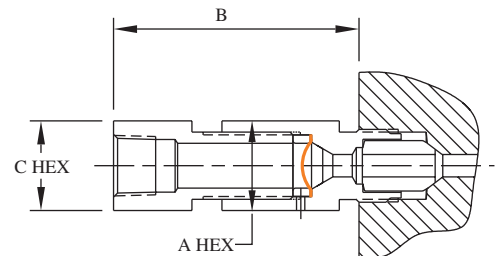

All dimensions are for reference only and are subject to change.
Dimensions in parentheses are millimeters (mm)

Tested to 14,000 feet (over 4200 meters)

As a supplier of equipment to the petroleum industry for over twenty years, BuTech offers an extensive line of check valves, needle valves, 2-, 3-, 4- & 5-way ball valves with 3/16" to 1" ports, as well as fittings, tubing and related equipment for petroleum production.



Our Sub-Sea Valves are custom designed for instrumentation, process control and chemical injection applications in the harshest environments. Designed for Remote Operated Vehicle (ROV) operation, these valves provide rugged protection, safety and reliability in template control panels, sub-sea wellheads and christmas trees.

Manufactured to meet the requirements of NACE MR-01-75, API Spec. 6A and 17D, and numerous other specifications, BuTech Sub-Sea Valves ensure trouble-free operation in hydrogen sulfides, corrosion inhibitors, paraffin thinners, hydraulic fluids and many other chemicals.

Please call the BuTech sales staff for custom design of a valve to meet your needs.



TOOLS AND INSTALLATION

Safe, leak-free operation of any high-pressure system is dependent on correctly prepared and installed connections. This section outlines proper instructions for the machining and assembly of BuTech L/P, M/P, and H/P connections. In addition, this section also offers hand and power tools to make the preparation of the tubing easier.



Equipment	Page
Tube Bender	T-5
Coning Tools, Manual	T-6
Coning Tools, Power	T-8
Threading Tools, Manual	T-7
Threading Tools, Power	T-9
Tube Vises	T-10
Connection Makeup, L/P	T-2
Connection Makeup, M/P	T-3
Connection Makeup, H/P	T-4



All dimensions are for reference only and are subject to change without notice.
Dimensions in parentheses are millimeters (mm).

LOW PRESSURE CONNECTIONS

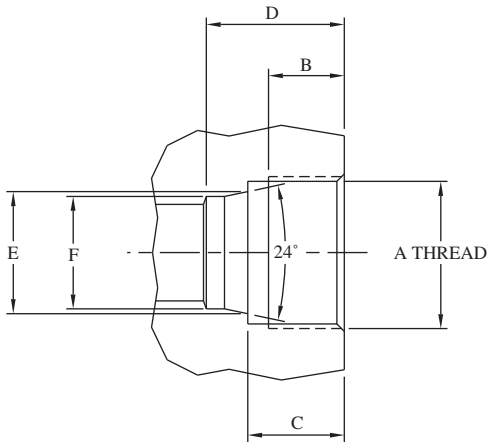

Connection	A Thread	B	C	D	E	F
1/8" L/P	3/8"-24	0.22" (5.6)	0.31" (7.9)	0.47" (11.9)	0.19" (4.8)	0.128" (3.3)
1/4" L/P	3/4"-16	0.34" (8.6)	0.44" (11.2)	0.69" (17.5)	0.35" (8.9)	0.257" (6.5)
1/4" SL/P	1/2"-20	0.38" (9.7)	0.44" (11.2)	0.69" (17.5)	0.35" (8.9)	0.257" (6.5)
3/8" L/P	3/4"-16	0.38" (9.7)	0.44" (11.2)	0.69" (17.5)	0.47" (11.9)	0.386" (9.8)
3/8" SL/P	5/8"-18	0.38" (9.7)	0.47" (11.9)	0.75" (19.1)	0.47" (11.9)	0.386" (9.8)
1/2" L/P	13/16"-16	0.41" (10.4)	0.50" (12.7)	0.81" (20.6)	0.60" (15.2)	0.515" (13.1)

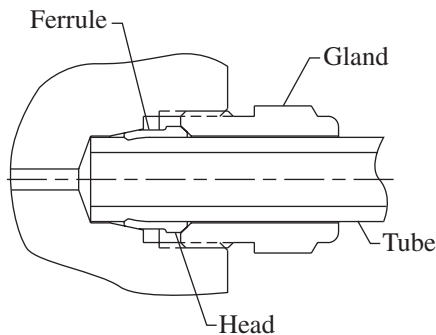

Tube Size	Engagement Allowance
1/8"	0.50" (12.7)
1/4"	0.75" (19.1)
3/8"	0.75" (19.1)
1/2"	0.88" (22.4)

Assembly Procedure

1. Cut tubing to desired length and de-burr, allowing extra length for proper engagement (see chart above)
2. Place gland nut and ferrule on tubing, making sure head of ferrule is toward gland nut. Push tubing into fitting until it bottoms.
3. Screw gland nut into connection until finger-tight.
4. Tighten gland nut approximately 1-1/4 turn with an open-end wrench.

Re-Assembly Procedure

1. Insert tubing with gland nut and ferrule into fitting
2. Screw gland nut into connection until finger-tight.
3. Tighten gland nut approximately 3/8 of a turn with an open-end wrench.

All dimensions are for reference only and are subject to change without notice.
Dimensions in parentheses are millimeters (mm).

MEDIUM PRESSURE CONNECTIONS

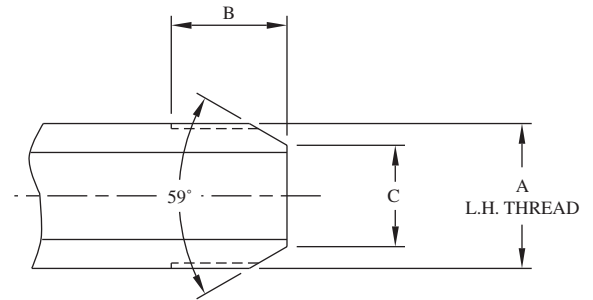
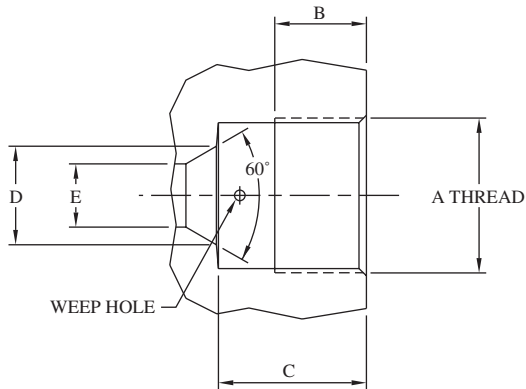

Connection	A Thread	B	C	D	E
1/4" M/P	7/16"-20	0.28" (7.1)	0.50" (12.7)	0.19" (4.8)	0.109" (2.8)
3/8" M/P	9/16"-18	0.38" (9.7)	0.62" (15.7)	0.31" (7.9)	0.203" (5.2)
9/16" M/P	13/16"-16	0.44" (11.2)	0.75" (19.1)	0.50" (12.7)	0.312" (7.9)
3/4" M/P	3/4"-14 NPSM	0.50" (12.7)	0.94" (23.9)	0.62" (15.7)	0.437" (11.1)
1" M/P	1-3/8"-12	0.81" (20.6)	1.31" (33.3)	0.88" (22.4)	0.562" (14.3)

Connection	A Thread*	B	C
1/4" M/P	1/4"-28	0.34" (8.6)	0.140" (3.6)
3/8" M/P	3/8"-24	0.44" (11.2)	0.250" (6.4)
9/16" M/P	9/16"-18	0.50" (12.7)	0.406" (10.3)
3/4" M/P	3/4"-16	0.62" (15.7)	0.562" (14.3)
1" M/P	1"-14	0.78" (19.8)	0.718" (18.2)

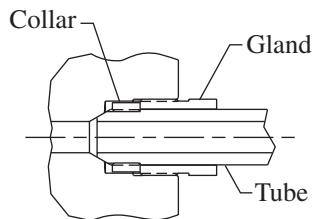

Assembly Procedure

1. Slip gland nut onto tubing or nipple.
2. Screw collar onto threaded end of tubing or nipple. Allow one or two threads to be exposed on tubing or nipple between collar and coned tubing.
3. Lubricate male threads of gland nut with a non-hardening lubricant suitable for use on stainless steel. Lubricant chosen should also be compatible with working temperature requirements.
4. Insert tubing into female connection of valve or fitting. Screw gland into connection until finger-tight.
5. Tighten gland nut to torque value shown at right which corresponds to connection size being assembled.

Tube Size	Engagement Allowance	Required Torque
1/4"	0.55" (14.0)	20 lb-ft 27 Nm
3/8"	0.69" (17.5)	30 lb-ft 41 Nm
9/16"	0.84" (21.3)	55 lb-ft 75 Nm
3/4"	1.01" (25.7)	90 lb-ft 122 Nm
1"	1.47" (37.3)	125 lb-ft 170 Nm



All dimensions are for reference only and are subject to change without notice.
Dimensions in parentheses are millimeters (mm).

HIGH PRESSURE CONNECTIONS

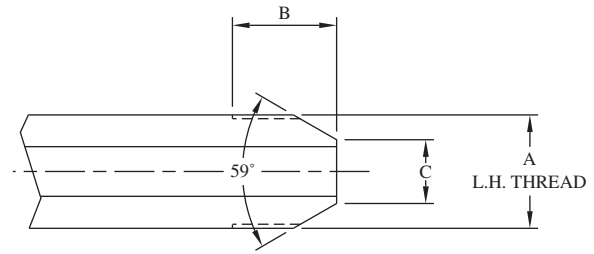
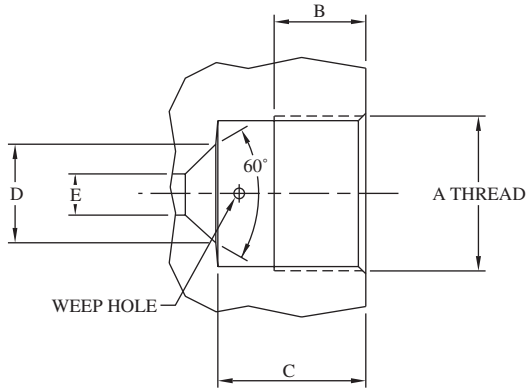

Connection	A Thread	B	C	D	E
1/4" H/P	9/16"-18	0.38" (9.7)	0.44" (11.2)	0.17" (4.3)	0.093" (2.4)
3/8" H/P	3/4"-16	0.53" (13.5)	0.62" (15.7)	0.26" (6.6)	0.125" (3.2)
9/16" H/P 60,000 PSI	1-1/8"-12	0.62" (15.7)	0.75" (19.1)	0.38" (9.7)	0.188" (4.8)
9/16" H/P 40,000 PSI	1-1/8"-12	0.62" (15.7)	0.75" (19.1)	0.38" (9.7)	0.188" (4.8)
1" H/P	1-3/8"-12	0.81" (20.6)	1.31" (33.3)	0.88" (22.2)	0.438" (11.1)

Connection	A Thread	B	C
1/4" H/P	1/4"-28	0.56" (14.2)	0.125" (3.2)
3/8" H/P	3/8"-24	0.75" (19.1)	0.219" (5.6)
9/16" H/P 60,000 PSI	9/16"-18	0.94" (23.9)	0.281" (7.1)
9/16" H/P 40,000 PSI	9/16"-18	0.94" (23.9)	0.281" (7.1)
1" H/P	1"-14	0.92" (23.2)	0.562" (14.3)

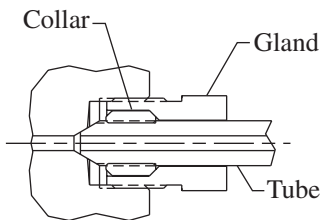

Assembly Procedure

- Slip gland nut onto tubing or nipple.
- Screw collar onto threaded end of tubing or nipple. Allow one or two threads to be exposed on tubing or nipple between collar and coned tubing.
- Lubricate male threads of gland nut with a non-hardening lubricant suitable for use on stainless steel. Lubricant chosen should also be compatible with working temperature requirements.
- Insert tubing into female connection of valve or fitting. Screw gland into connection until finger-tight.
- Tighten gland nut to torque value shown at right which corresponds to connection size being assembled.

Tube Size	Engagement Allowance	Required Torque
1/4"	0.49" (12.4)	25 lb-ft 34 Nm
3/8"	0.68" (17.3)	50 lb-ft 68 Nm
9/16"	0.86" (21.8)	100 lb-ft 136 Nm
1"	1.60" (40.6)	150 lb-ft 203 Nm

All dimensions are for reference only and are subject to change without notice.
Dimensions in parentheses are millimeters (mm).

TUBE BENDER

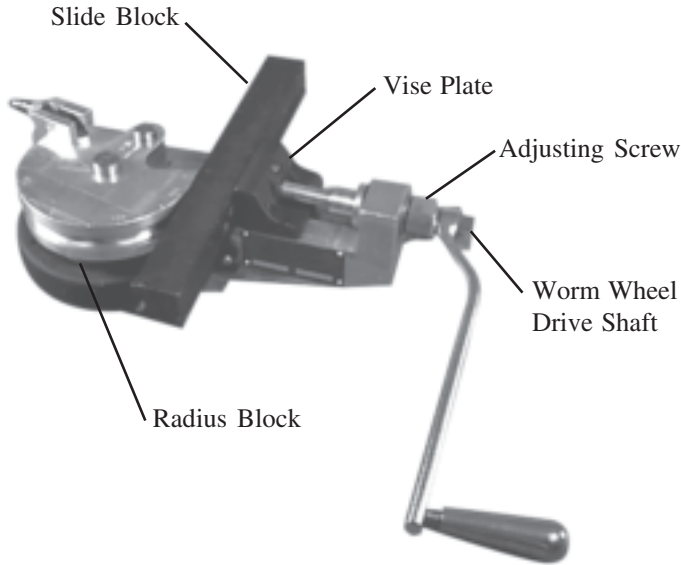

The BuTech tube bender is designed to bend heavy wall tubing and provide fast, accurate and reliable bending with only one setup. The tube bender is complete with slide block, radius block and bending shoes in a portable, lockable case.

This unit is compact and weight is held to a minimum. It may be easily transported to any area for service use where a vise is available for holding the bender.

The bender operating mechanism consists of a cast aluminum frame and base, with a manual crank-operated steel worm gear mechanism. A 60:1 gear ratio enables the operator to make bends up to 180° in one continuous smooth operation without strain or fatigue. Center drive shaft and worm gear shaft are supported with pre-lubricated ball bearings. The worm gear has a ball-type thrust bearing.

Worm wheel and gear are enclosed for safety, and protection from external damage. Worm wheel drive can be readily disengaged to allow quick return of the radius block after bending without being returned through the gear train.

An adjustable screw vise, guided on the bender frame, is used to position the slide block against the radius die block to hold the tube for proper bending. Hardened steel face of the vise guides the slide block parallel to the bender centerline during the bending operation. The bender is designed to permit use of mandrel equipment when desired. Standard slide block is furnished with grooves for tube sizes 1/4", 3/8" and 9/16".

The crank handle which operates the bender may also be used to adjust the screw connected to the vise plate. This screw telescopes so it will not project outward to interfere with rotation of the operating handle during the bending operation.

The main base of the bender has a square boss for clamping in a bench vise, permitting 90° positioning; or the bender base can be mounted to an adapter unit and fastened to a work bench and used with mandrel equipment when extremely smooth bends in thin-wall tubing are required.

Each radius die block has graduated markings from 0° to 180° at intervals of 15° to indicate degree of bend. Each block has an integral clamp device for easy, quick, positive clamping of the tube. Radius die blocks can be furnished for all tube sizes with standard bends up to 5" radius. Each radius block is marked with tube size and radius for identification.

To order a complete tube bender, specify catalog number from chart below:

Included Radius Block sizes	Catalog Number
1/4", 3/8", 9/16"	MTB469
1/4"	MTB4
3/8"	MTB6
9/16"	MTB9

To order extra radius blocks, specify catalog number from chart below:

Tube O.D.	Catalog Number	Bend Radius	Min Tube Length*
1/4"	PH-2043	1.25" (31.75)	8.00" (203.2)
3/8"	PH-2044	1.75" (44.5)	8.00" (203.2)
9/16"	PH-2045	2.62" (66.5)	14.00" (355.6)

*For 90° bend

Case size: 22" x 9.50" x 9.75"
(559mm x 241mm x 248mm)

Weight: 25 lbs (11 kg)



All dimensions are for reference only and are subject to change without notice.
Dimensions in parentheses are millimeters (mm).



HAND CONING TOOLS

The BuTech Hand Coning Tool uses a precision collet to maintain concentricity between the tube and the cutter blades. This unique feature makes the BuTech hand coning tool the perfect tool for machining a cone at the end of a tube, or for re-dressing an existing, damaged cone connection.



Connection	Catalog Number	Replacement Parts	
		Blade	Collet
1/4" M/P	20HCT4	20BL4	PH-1905
3/8" M/P	20HCT6	20BL6	PH-1903
9/16" M/P	20HCT9	20BL9	PH-1893
3/4" M/P	20HCT12	20BL12	PH-1859
1" M/P	20HCT16	20BL16	PH-1858
1/4" H/P	60HCT4	60BL4	PH-1905
3/8" H/P	60HCT6	60BL6	PH-1903
9/16" H/P	60HCT9	60BL9	PH-1893
1" H/P	30HCT16	30BL16	PH-1858



Instructions for Operation

1. Place the body of the hand coning tool in a suitable vise. The crank handle end of the tool should be elevated slightly so that the lubricant can flow down the lubricant channel to the cutter head. Be sure to provide adequate clearance for the rotation of the crank handle.
2. Fully retract the cutter blades past the access window by turning the knurled nut counter-clockwise.
3. Loosen the gland at the front of the tool and insert the tube. The end of the tube should be even with the front of the access window (nearest the cutter blade), but should not contact the cutter blade.
4. Tighten the gland holding the tube.
5. Apply a liberal amount of lubricant to the exposed end of the tube, the cutter blades and through the lubrication channel at the crank handle. Important: Apply lubricant frequently and liberally throughout the cutting operation.
6. Turn the knurled nut clockwise to gently touch the cutter blade to the tube, then back the knurled nut off 1/4 turn.
7. Crank the handle clockwise to spin the cutter blades. Turn the knurled nut clockwise to engage and to begin cutting the tube. For best results, establish a gentle but constant feed of the knurled nut and a smooth and continuous cutter rotation. Do not try to remove too much material at once. Let the cutter blades do the work. Thin, curled machining chips should fall freely from the lower access window. Note: Back the cutter blades off the work-piece before interrupting the cut. Use compressed air or a small brush to clean the accumulation of chips from the blades and work-piece throughout the coning operation. The operation is complete when the blades begin to cut the land area at the base of the cone.
8. Back the cutter blades off the work-piece and loosen the gland to remove the tubing. Inspect the cone for completeness and surface finish.

Important: Clean the machining chips from the blade and from the collet before coning the next tube.

All dimensions are for reference only and are subject to change without notice.
Dimensions in parentheses are millimeters (mm).

HAND THREADING TOOLS

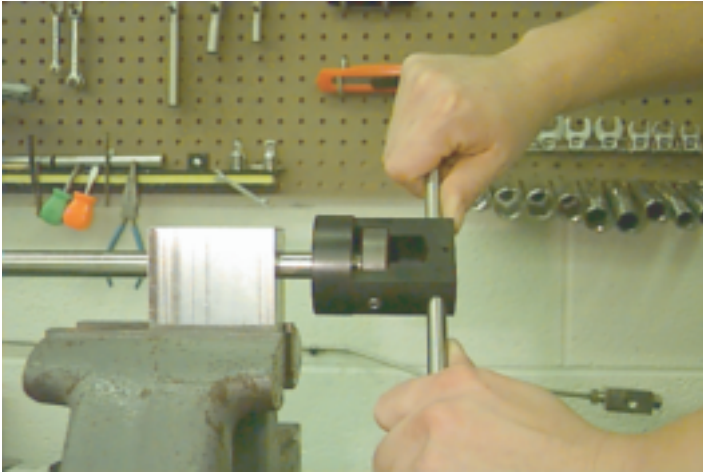

The BuTech Hand Threading Tool is designed to permit on-site end preparation for medium and high pressure tubing installations from 1/4" to 1" O.D.

The manual threading tool uses an adjustable split die and a precision guide bushing to cut a perfect thread.

Connection	Catalog Number	Replacement Parts	
		Die	Bushing
1/4" M/P	THT4-H	TD4	TB4
3/8" M/P	THT6-H	TD6	TB6
9/16" M/P	THT9-H	TD9	TB9
3/4" M/P	THT12-H	TD12	TB12
1" M/P	THT16-H	TD16	TB16
1/4" H/P	THT4-H	TD4	TB4
3/8" H/P	THT6-H	TD6	TB6
9/16" H/P	THT9-H	TD9	TB9
1" H/P	THT16-H	TD16	TB16

Instructions for Operation

1. Start with tubing that has been coned, either in a lathe, or with a BuTech Hand or Power Coning Tool.
2. Secure tube in a tube vise, with no more than the recommended length of tubing extending beyond the face of the vise.
3. Lubricate the end of the tube and slide on the threading tool.
4. Take a firm grip on the handles of the tool and, with a steady pressure, turn the tool counter-clockwise. Approximately every half turn of the tool, reverse direction to break off and remove chips. Important: Apply lubricant frequently and liberally throughout the cutting operation.
5. Continue threading until the proper length of thread is reached. Remove tool from the tubing end.

Important: Clean the chips from the die and body of the tool before threading the next tube.

Tube O.D.	Recommended Length
1/4"	1.25" - 1.50" (31.8) - (38.1)
3/8"	1.25" - 1.50" (31.8) - (38.1)
9/16"	1.75" - 2.00" (44.5) - (50.8)
3/4"	3.00" - 3.50" (76.2) - (88.9)
1"	3.00" - 3.50" (76.2) - (88.9)

Connection	Thread Length
1/4" M/P	0.34" (8.6)
3/8" M/P	0.44" (11.2)
9/16" M/P	0.50" (12.7)
3/4" M/P	0.62" (15.7)
1" M/P	0.78" (19.8)
1/4" H/P	0.56" (14.2)
3/8" H/P	0.75" (19.1)
9/16" H/P	0.94" (23.9)
1" H/P	0.92" (23.2)

All dimensions are for reference only and are subject to change without notice.
Dimensions in parentheses are millimeters (mm).



POWER CONING TOOLS

The BuTech Power Coning Tool is designed to adapt easily to any power hand drill. This unique feature makes the BuTech Power Coning Tool the perfect tool for fast machining of several tube ends.

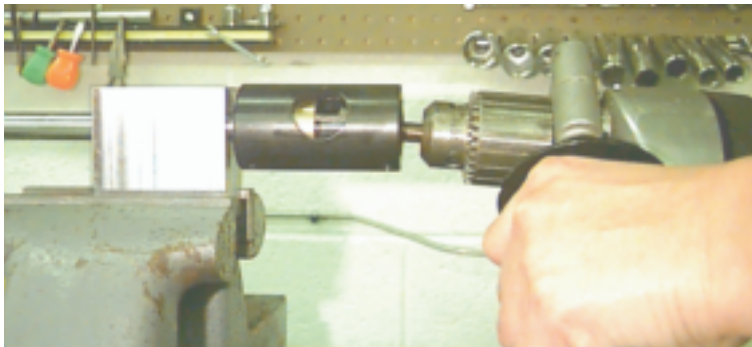

Connection	Catalog Number	Replacement Parts	
		Blade	Bushing
1/4" M/P	20CT4	20BL4	CB4
3/8" M/P	20CT6	20BL6	CB6
9/16" M/P	20CT9	20BL9	CB9
3/4" M/P	20CT12	20BL12	CB12
1" M/P	20CT16	20BL16	CB16
1/4" H/P	60CT4	60BL4	CB4
3/8" H/P	60CT6	60BL6	CB6
9/16" H/P	60CT9	60BL9	CB9
1" H/P	30CT16	30BL16	CB16

Instructions for Operation

1. Secure tube in a tube vise, with no more than the recommended length of tubing extending beyond the face of the vise.
2. Mount threading tool in a 3/8" or 1/2" variable speed power drill. Lubricate the end of the tube and slide on tool.
3. Apply a steady pressure against the end of the tube while the drill motor/tool cuts the cone. The tool can be removed any time during the coning operation for inspection. Important: Apply lubricant frequently and liberally throughout the cutting operation.
4. Continue cutting until the cone is complete. The tool will stop cutting when the tube angle and facing is complete.

Important: Clean the chips from the blade and body of the tool before coning the next tube.

Tube O.D.	Recommended Length
1/4"	1.25" - 1.50" (31.8) - (38.1)
3/8"	1.25" - 1.50" (31.8) - (38.1)
9/16"	1.75" - 2.00" (44.5) - (50.8)
3/4"	3.00" - 3.50" (76.2) - (88.9)
1"	3.00" - 3.50" (76.2) - (88.9)

All dimensions are for reference only and are subject to change without notice.
Dimensions in parentheses are millimeters (mm).

POWER THREADING TOOLS

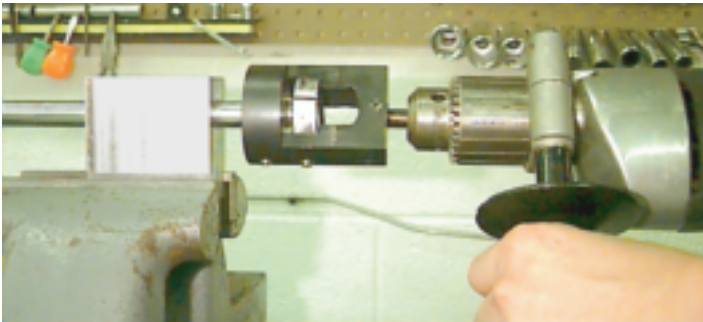

The BuTech Power Threading Tool is designed to adapt easily to any power hand drill. This unique feature makes the BuTech Power Threading Tool the perfect tool for fast machining of several tube ends.

Connection	Catalog Number	Replacement Parts	
		Die	Bushing
1/4" M/P	THT4-P	TD4	TB4
3/8" M/P	THT6-P	TD6	TB6
9/16" M/P	THT9-P	TD9	TB9
3/4" M/P	THT12-P	TD12	TB12
1" M/P	THT16-P	TD16	TB16
1/4" H/P	THT4-P	TD4	TB4
3/8" H/P	THT6-P	TD6	TB6
9/16" H/P	THT9-P	TD9	TB9
1" H/P	THT16-P	TD16	TB16

Instructions for Operation

1. Start with tubing that has been coned, either in a lathe, or with a BuTech Hand or Power Coning Tool.
2. Secure tube in a tube vise, with no more than the recommended length of tubing extending beyond the face of the vise.
3. Mount threading tool in a 3/8" or 1/2" variable speed power drill. Lubricate the end of the tube and slide on tool.
4. Make sure the drill motor is set to turn counter-clockwise. Apply a steady pressure against the end of the tube with the drill motor/tool as the threads are cut. Important: Apply lubricant frequently and liberally throughout the cutting operation.
5. Continue threading until the proper length of thread is reached. Reverse direction on the drill motor and remove tool from the tubing end.

Important: Clean the chips from the die and body of the tool before threading the next tube.

Tube O.D.	Recommended Length
1/4"	1.25" - 1.50" (31.8) - (38.1)
3/8"	1.25" - 1.50" (31.8) - (38.1)
9/16"	1.75" - 2.00" (44.5) - (50.8)
3/4"	3.00" - 3.50" (76.2) - (88.9)
1"	3.00" - 3.50" (76.2) - (88.9)

Connection	Thread Length
1/4" M/P	0.34" (8.6)
3/8" M/P	0.44" (11.2)
9/16" M/P	0.50" (12.7)
3/4" M/P	0.62" (15.7)
1" M/P	0.78" (19.8)
1/4" H/P	0.56" (14.2)
3/8" H/P	0.75" (19.1)
9/16" H/P	0.94" (23.9)
1" H/P	0.92" (23.2)



All dimensions are for reference only and are subject to change without notice.
Dimensions in parentheses are millimeters (mm).

TUBE VISES



Tube O.D.	Catalog Number
1/4"	TV4
3/8"	TV6
9/16"	TV9
3/4"	TV12
1"	TV16

- Lightweight and inexpensive.
- No collapsing of tubing.
- Better holding power on tubes.
- No soft jaws required on vises
- No marking on OD of tubing
- Use as a stop gauge when coning and threading

All dimensions are for reference only and are subject to change without notice.
Dimensions in parentheses are millimeters (mm).

TECHNICAL INFORMATION

BuTech designs all pressure-containing equipment to meet or exceed the applicable requirements of Section VIII, Division 1 or Division 2 of the ASME Boiler and Pressure Vessel Code and applicable requirements of B31.3, ASME Code for Pressure Piping, maintaining a minimum safety factor of three-to-one (3:1). Furthermore, we believe that the design and manufacture of these components in accordance with this code meets or exceeds the requirements of numerous other national and international codes, specifications and requirements.

BuTech presents this section as a guideline in assisting of proper selection of material, design features, and options for valves, fittings, and tubing that require precise control of liquid and gas flows.

All charts and tables are for reference only because of the many process variables.

BuTech's technical staff is available to assist in any questions concerning this information, or assist in selecting BuTech product.

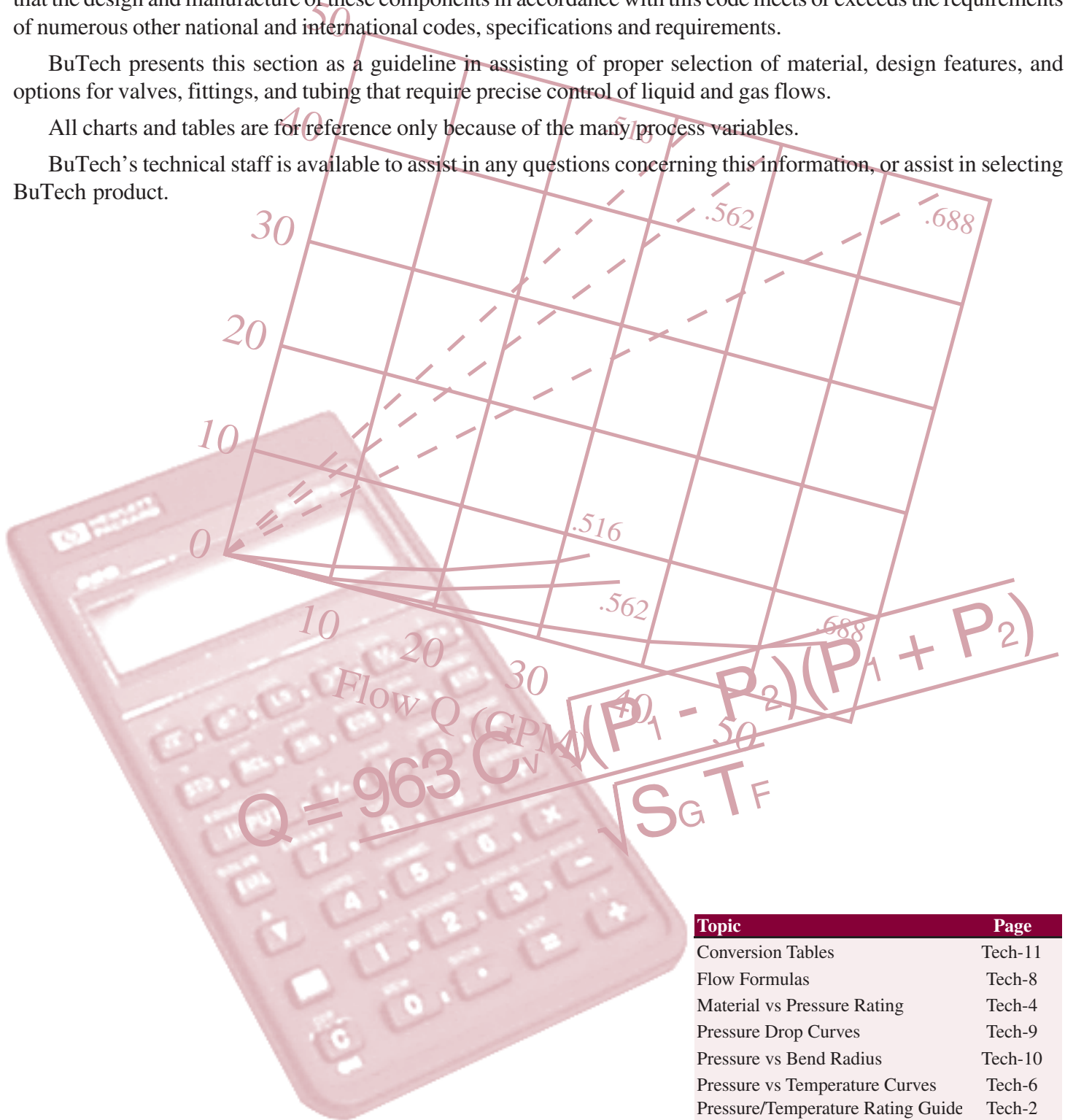

Topic	Page
Conversion Tables	Tech-11
Flow Formulas	Tech-8
Material vs Pressure Rating	Tech-4
Pressure Drop Curves	Tech-9
Pressure vs Bend Radius	Tech-10
Pressure vs Temperature Curves	Tech-6
Pressure/Temperature Rating Guide	Tech-2



PRESSURE/TEMPERATURE RATING GUIDE

Information in this rating guide is furnished for reference in approximating the pressure/temperature capabilities of BuTech valves with various options. To determine approximate ratings, the following factors should be considered:

- Refer to individual sections to determine pressure rating of component at room temperature.

- Refer to Pressure/Temperature Rating Curve on page Tech-3 to determine pressure at desired temperature.
- Refer to tubing section for pressure ratings of standard tubing at various temperatures to 800°F (427°C).
- Note maximum temperature ratings for needle valves with various packing options in the table below.
- Note temperature information checklist on page Tech-3.

Valve Series	Stem Type	Standard Glass-Filled Teflon		Standard Glass-Filled Teflon/Nylatron		Optional Virgin Teflon Packing		Optional Grafoil ¹		°F °C
		Min	Max	Min	Max	Min	Max	Min	Max	
SLPV ²	Vee or Regulating Metal to Metal	-100 (-73)	650 (343)	N/A	N/A	-100 (-73)	450 (232)	-10 (-18)	800 (427)	°F °C
SFPV	Vee or Regulating Metal to Metal	-100 (-73)	650 (343)	N/A	N/A	-100 (-73)	450 (232)	-10 (-18)	800 (427)	°F °C
DHP	Vee or Regulating Metal to Metal	-100 (-73)	650 (343)	N/A	N/A	-100 (-73)	450 (232)	-10 (-18)	800 (427)	°F °C
20UV ³	Vee or Regulating Metal to Metal	-100 (-73)	650 (343)	N/A	N/A	-100 (-73)	450 (232)	-10 (-18)	800 (427)	°F °C
30UV	Vee or Regulating Metal to Metal	-100 (-73)	650 (343)	N/A	N/A	-100 (-73)	450 (232)	-10 (-18)	800 (427)	°F °C
40UV	Vee or Regulating Metal to Metal	N/A	N/A	-100 (-73)	230 (110)	N/A	N/A	-10 (-18)	800 (427)	°F °C
60UV	Vee or Regulating Metal to Metal	N/A	N/A	-100 (-73)	230 (110)	N/A	N/A	-10 (-18)	800 (427)	°F °C

Notes:

1. Optional grafoil packing not recommended for hydrogen or helium service.
2. Compression type (L/P) connections not recommended for service above 650°F (343°C) or below 0°F (-18°C).
For these applications, BuTech recommends medium pressure M/P Coned-and-Threaded connections.
3. Chart above refers to sizes through 9/16" only. Consult factory for 3/4" and 1" sizes.

PRESSURE/TEMPERATURE RATING GUIDE

Pressure/Temperature Rating Curve for Cold Worked 316 S.S.

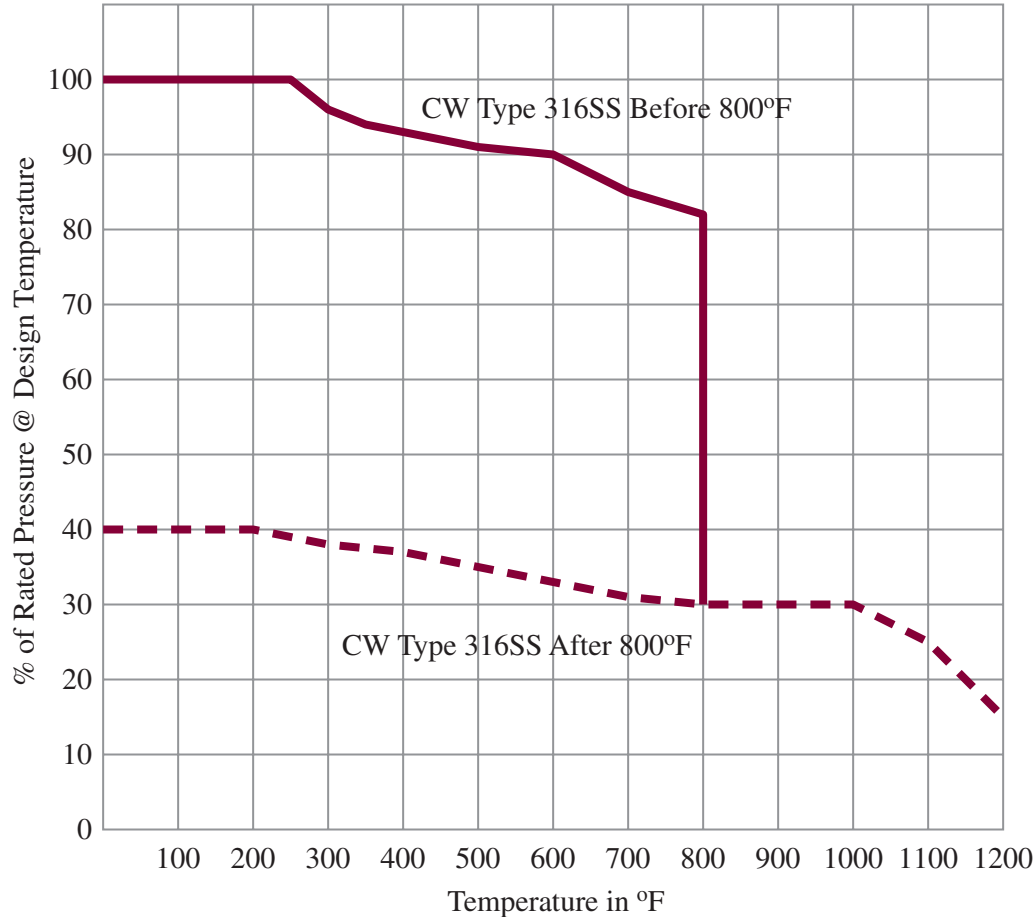

Notes:

1. This curve is valid for cold-worked type 316 stainless steel components **providing operating temperature does not exceed 800°F (426°C)**. After this temperature, the material is **PERMANENTLY** altered, and the component should be considered as annealed from then on, derating it to 40% of its cold-worked value.
2. Curves and ratings presented here are average values for reference only, and can be significantly affected by pressure and temperature characteristics of packing and trim materials. For extreme pressure/temperature requirements, please contact factory for recommendations.
3. For pressure/temperature information for other materials, please see pages Tech-4 thru Tech-7.

Temperature Information Checklist

	-423° to -100°F -253° to -73°C	-100° to 0°F -73° to -18°C	0° to 650°F -18° to 343°C	650° to 800°F 343° to 427°C	800° to 1200°F 427° to 649°C
Compression Type Connections	Not Recommended	Not Recommended	Recommended	Not Recommended	Not Recommended
Coned-and-Threaded Connections	Required	Required	Recommended	Required	Required
Extended Stuffing Box	Required (See note 1)	May be required (See note 2)	May be required (See note 2)	May be required (See note 2)	Required (See note 3)

Notes:

1. Packing temperature not to go below -100°F (-73°)
2. Extended Stuffing box required for operation below -100°F (-73°) and above 450°F (232°C) (with Teflon packing) or 600°F (315°C) (with Teflon Glass packing).
3. Packing temperature not to exceed 800°F (427°C)



MATERIAL VS. PRESSURE RATING - VALVES/FITTINGS

Material vs. Pressure Rating @ Room Temperature*									
Valve Series	Conn	Tube Size	316CW (Std)	Hastelloy C276	Inconel 600	Inconel 625	Monel 400	Super Duplex 2507	Titanium 6AL4V
SLPV2	1/8" L/P	1/8"	15,000 PSI 1030 bar	12,500 PSI 860 bar	12,500 PSI 860 bar	12,500 PSI 860 bar	11,000 PSI 760 bar	12,500 PSI 860 bar	12,500 PSI 860 bar
SLPV4	1/4" SL/P	1/4"	11,500 PSI 790 bar	10,000 PSI 690 bar	7,500 PSI 520 bar	10,000 PSI 690 bar	7,000 PSI 480 bar	11,500 PSI 790 bar	11,500 PSI 790 bar
SLPV6	3/8" SL/P	3/8"	7,500 PSI 520 bar	7,500 PSI 520 bar	7,500 PSI 520 bar	7,500 PSI 520 bar	6,500 PSI 450 bar	7,500 PSI 520 bar	7,500 PSI 520 bar
SLPV8	1/2" L/P	1/2"	5,500 PSI 380 bar	5,500 PSI 380 bar	5,500 PSI 380 bar	5,500 PSI 380 bar	4,600 PSI 320 bar	5,500 PSI 380 bar	5,500 PSI 380 bar
20UV4	1/4" M/P	1/4"	20,000 PSI 1380 bar	12,000 PSI 830 bar	9,000 PSI 620 bar	12,000 PSI 830 bar	10,000 PSI 690 bar	20,000 PSI 1380 bar	20,000 PSI 1380 bar
20UV6	3/8" M/P	3/8"	20,000 PSI 1380 bar	12,000 PSI 830 bar	9,000 PSI 620 bar	12,000 PSI 830 bar	10,000 PSI 690 bar	20,000 PSI 1380 bar	20,000 PSI 1380 bar
20UV9	9/16" M/P	9/16"	20,000 PSI 1380 bar	12,000 PSI 830 bar	9,000 PSI 620 bar	12,000 PSI 830 bar	10,000 PSI 690 bar	20,000 PSI 1380 bar	20,000 PSI 1380 bar
20V12	3/4" M/P	3/4"	20,000 PSI 1380 bar	12,000 PSI 830 bar	9,000 PSI 620 bar	12,000 PSI 830 bar	10,000 PSI 690 bar	20,000 PSI 1380 bar	20,000 PSI 1380 bar
20V16	1" M/P	1"	20,000 PSI 1380 bar	12,000 PSI 830 bar	9,000 PSI 620 bar	12,000 PSI 830 bar	10,000 PSI 690 bar	20,000 PSI 1380 bar	20,000 PSI 1380 bar
30UV4	1/4" H/P	1/4"	30,000 PSI 2070 bar	21,000 PSI 1450 bar	16,500 PSI 1140 bar	20,000 PSI 1380 bar	12,000 PSI 830 bar	30,000 PSI 2070 bar	30,000 PSI 2070 bar
30UV6	3/8" H/P	3/8"	30,000 PSI 2070 bar	21,000 PSI 1450 bar	16,500 PSI 1140 bar	20,000 PSI 1380 bar	12,000 PSI 830 bar	30,000 PSI 2070 bar	30,000 PSI 2070 bar
30UV9	9/16" H/P	9/16"	30,000 PSI 2070 bar	30,000 PSI 2070 bar	20,000 PSI 1380 bar	30,000 PSI 2070 bar	12,000 PSI 830 bar	30,000 PSI 2070 bar	30,000 PSI 2070 bar
30V16	1" H/P	3/4"	30,000 PSI 2070 bar	21,000 PSI 1450 bar	16,500 PSI 1140 bar	20,000 PSI 1380 bar	12,000 PSI 830 bar	30,000 PSI 2070 bar	30,000 PSI 2070 bar
40UV9	9/16" H/P	9/16"	40,000 PSI 2760 bar	35,000 PSI 2410 bar	25,000 PSI 1720 bar	35,000 PSI 2410 bar	20,000 PSI 1380 bar	40,000 PSI 2760 bar	40,000 PSI 2760 bar
60UV4	1/4" H/P	1/4"	60,000 PSI 4140 bar	35,000 PSI 2410 bar	27,500 PSI 1900 bar	35,000 PSI 2410 bar	20,000 PSI 1380 bar	60,000 PSI 4140 bar	60,000 PSI 4140 bar
60UV6	3/8" H/P	3/8"	60,000 PSI 4140 bar	35,000 PSI 2410 bar	27,500 PSI 1900 bar	35,000 PSI 2410 bar	20,000 PSI 1380 bar	60,000 PSI 4140 bar	60,000 PSI 4140 bar
60UV9	9/16" H/P	9/16"	60,000 PSI 4140 bar	35,000 PSI 2410 bar	27,500 PSI 1900 bar	35,000 PSI 2410 bar	20,000 PSI 1380 bar	60,000 PSI 4140 bar	60,000 PSI 4140 bar

Notes:

1. For ratings at elevated temperatures, see Pressure/Temperature rating curves on pages Tech-6 and Tech-7.
2. Tubing, connection type and/or packing material may limit maximum temperature rating. See pages Tech-2 and Tech-3 for details.

MATERIAL VS PRESSURE RATING - TUBING

Tube Size OD x ID	Material vs. Pressure Rating @ Room Temperature ^{1,2}					
	316CW (Std) ³	304CW	Hastelloy C276	Inconel 600	Inconel 625	Monel 400
1/8" x .062	12,500 PSI 860 bar	12,500 PSI 860 bar	12,500 PSI 860 bar	12,500 PSI 860 bar	12,500 PSI 860 bar	10,000 PSI 690 bar
1/8" x .069	9,500 PSI 650 bar	9,500 PSI 650 bar	12,500 PSI 860 bar	10,500 PSI 720 bar	12,500 PSI 860 bar	9,500 PSI 650 bar
1/8" x .085	6,000 PSI 410 bar	6,000 PSI 410 bar	12,500 PSI 860 bar	7,000 PSI 480 bar	12,500 PSI 860 bar	6,000 PSI 410 bar
1/4" x .125	11,500 PSI 790 bar	11,500 PSI 790 bar	11,500 PSI 790 bar	11,500 PSI 790 bar	11,500 PSI 790 bar	10,000 PSI 690 bar
1/4" x .180	5,200 PSI 360 bar	5,200 PSI 360 bar	7,000 PSI 480 bar	6,250 PSI 430 bar	550 bar	5,500 PSI 380 bar
1/4" x .194	4,500 PSI 310 bar	4,500 PSI 310 bar	6,000 PSI 410 bar	4,800 PSI 330 bar	8,000 PSI 550 bar	4,300 PSI 300 bar
3/8" x .250	7,500 PSI 520 bar	7,500 PSI 520 bar	7,500 PSI 520 bar	7,500 PSI 520 bar	7,500 PSI 520 bar	6,500 PSI 450 bar
3/8" x .277	5,000 PSI 340 bar	5,000 PSI 340 bar	6,200 PSI 430 bar	5,600 PSI 390 bar	7,500 PSI 520 bar	5,200 PSI 360 bar
3/8" x .305	3,300 PSI 230 bar	3,300 PSI 230 bar	4,500 PSI 310 bar	4,000 PSI 280 bar	6,000 PSI 410 bar	3,500 PSI 240 bar
1/2" x .375	5,500 PSI 380 bar	5,500 PSI 380 bar	7,000 PSI 480 bar	5,000 PSI 340 bar	7,000 PSI 480 bar	4,600 PSI 320 bar
1/2" x .402	3,500 PSI 240 bar	3,500 PSI 240 bar	5,000 PSI 340 bar	4,000 PSI 280 bar	7,000 PSI 480 bar	3,500 PSI 240 bar
1/4" x .109	20,000 PSI 1380 bar	20,000 PSI 1380 bar	10,000 PSI 690 bar	10,000 PSI 690 bar	15,000 PSI 1030 bar	10,000 PSI 690 bar
3/8" x .203	20,000 PSI 1380 bar	20,000 PSI 1380 bar	10,000 PSI 690 bar	10,000 PSI 690 bar	15,000 PSI 1030 bar	10,000 PSI 690 bar
9/16" x .312	20,000 PSI 1380 bar	20,000 PSI 1380 bar	10,000 PSI 690 bar	10,000 PSI 690 bar	15,000 PSI 1030 bar	10,000 PSI 690 bar
9/16" x .359	10,000 PSI 690 bar	10,000 PSI 690 bar	8,000 PSI 550 bar	6,000 PSI 410 bar	10,000 PSI 690 bar	6,000 PSI 410 bar
3/4" x .438	20,000 PSI 1380 bar	20,000 PSI 1380 bar	10,000 PSI 690 bar	10,000 PSI 690 bar	15,000 PSI 1030 bar	10,000 PSI 690 bar
3/4" x .516	10,000 PSI 690 bar	10,000 PSI 690 bar	8,000 PSI 550 bar	6,000 PSI 410 bar	10,000 PSI 690 bar	6,000 PSI 410 bar
1" x .438	30,000 PSI 2070 bar	30,000 PSI 2070 bar	18,000 PSI 1240 bar	13,250 PSI 910 bar	15,000 PSI 1030 bar	12,750 PSI 880 bar
1" x .562	20,000 PSI 1380 bar	20,000 PSI 1380 bar	10,000 PSI 690 bar	10,000 PSI 690 bar	15,000 PSI 1030 bar	10,000 PSI 690 bar
1" x .688	10,000 PSI 690 bar	10,000 PSI 690 bar	8,000 PSI 550 bar	6,000 PSI 410 bar	10,000 PSI 690 bar	6,000 PSI 410 bar
1/4" x .083	60,000 PSI 4140 bar	60,000 PSI 4140 bar	28,000 PSI 1930 bar	22,000 PSI 1520 bar	38,000 PSI 2620 bar	20,000 PSI 1380 bar
3/8" x .125	60,000 PSI 4140 bar	60,000 PSI 4140 bar	28,000 PSI 1930 bar	22,000 PSI 1520 bar	38,000 PSI 2620 bar	20,000 PSI 1380 bar
9/16" x .188	60,000 PSI 4140 bar	60,000 PSI 4140 bar	28,000 PSI 1930 bar	22,000 PSI 1520 bar	38,000 PSI 2620 bar	20,000 PSI 1380 bar
9/16" x .250	40,000 PSI 2760 bar	40,000 PSI 2760 bar	20,000 PSI 1380 bar	15,000 PSI 1030 bar	28,000 PSI 1930 bar	15,000 PSI 1030 bar

Notes:

1. In some instances, the pressure rating of tubing is lower than the rating of the valves and fittings.
2. For ratings at elevated temperatures, see Pressure/Temperature rating curves on pages Tech-6 and Tech-7.
3. Tubing, connection type and/or packing material may limit maximum temperature rating. See pages Tech-2 and Tech-3 for further details.
4. Except low pressure series which is 316 annealed.
5. Tubing is seamless except Hastelloy C276 which is welded and drawn or seamless.



PRESSURE VS TEMPERATURE RATING CURVES

Curves and ratings presented here are average values for reference only. These values can be significantly affected by pressure and temperature characteristics of trim materials, stem packing materials or o-ring, and connection type. Other options such as extended stuffing box will be required to achieve the maximum temperature rating. See pages Tech-2 through Tech-3 for details.

For extreme pressure/temperature requirements, please contact factory for recommendations.

To obtain the maximum pressure rating at an elevated temperature, multiply the maximum pressure rating of the item in special material at room temperature, by the elevated temperature factor (% of Design Temperature)

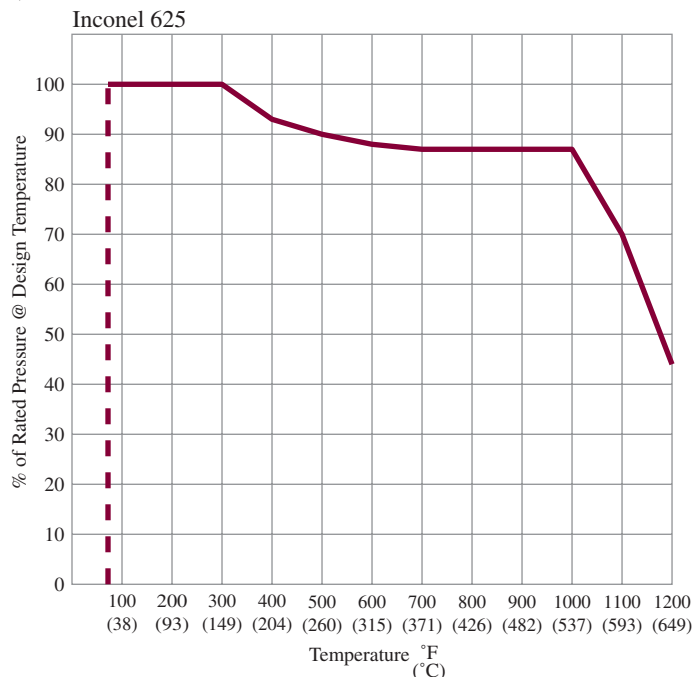
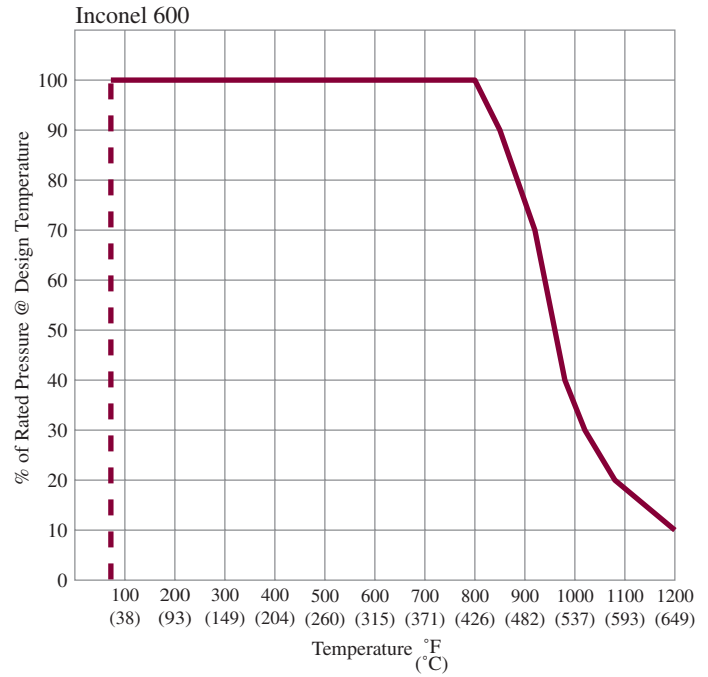
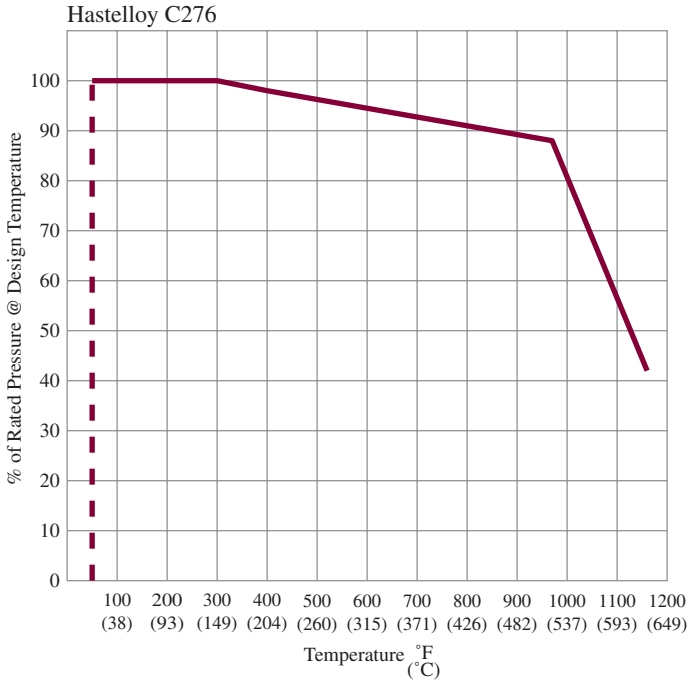

PRESSURE VS TEMPERATURE RATING CURVES

Example: Determine the pressure rating of a 1/4" 30UV valve constructed of Hastelloy C276 with an operating temperature of 600°F.

From the Material vs Pressure Rating chart on page Tech-4, the maximum pressure rating for a 30UV valve constructed of Hastelloy C276 would be 21,000 PSI at room temperature.

Turn to the Pressure vs Temperature rating curves on pages Tech-6 and Tech-7. Find 600°F on the X-axis of the Hastelloy C-276 chart. Follow the line up to read a value of 95%. Multiplying the room temperature rating by this reduction factor (21,000 x .95) yields a rating of 19,950 PSI at 600°F.

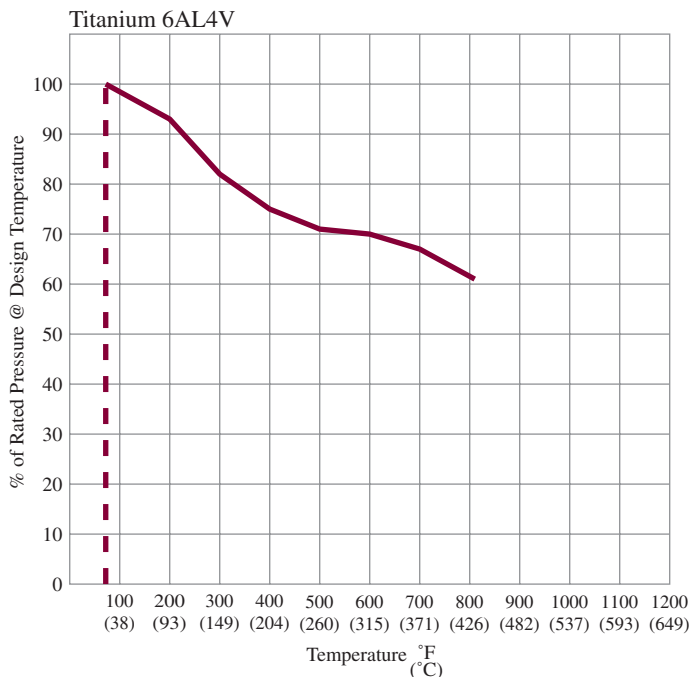
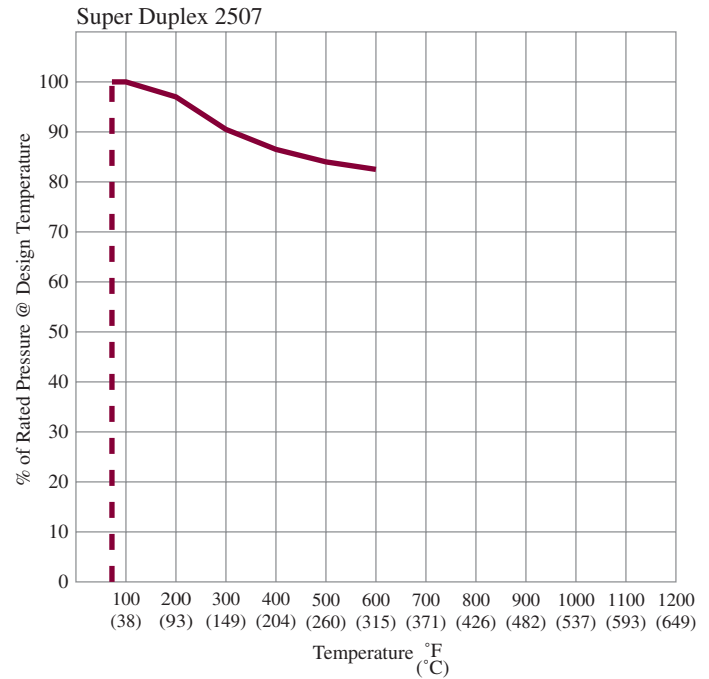
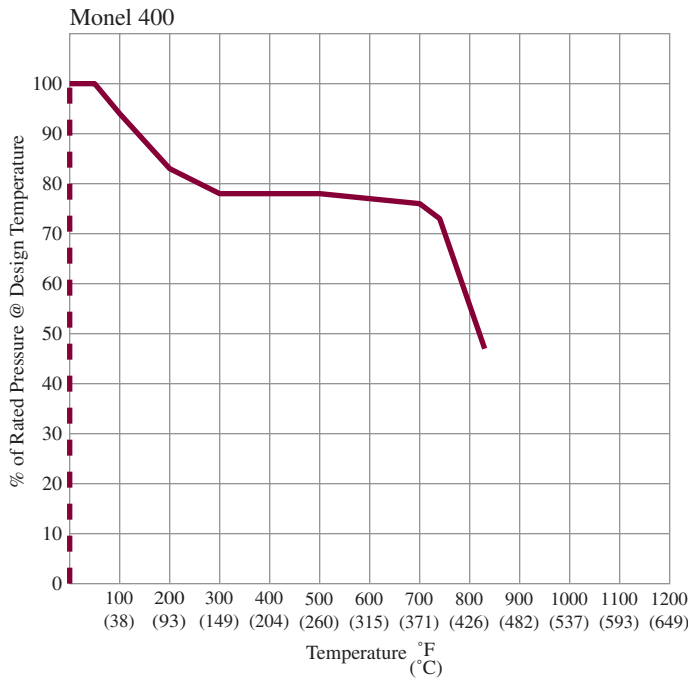

FLOW FORMULAS

Coefficient of flow (Cv) of a valve is the volume of water in U.S. gallons per minute at room temperature, which will flow through the valve with the stem fully open, with a pressure drop of 1 PSI across the valve. Cv is the valve sizing factor that permits selection of the appropriate valve to meet the flow requirements of a given fluid system.

The Cv values shown on the technical page of the previous sections represent the full-open Cv for that particular valve. In determining estimated capacity, this Cv value should be used in the following formulas.

Flow of Liquid in U.S. Gallons/min

$$V = \frac{C_v \sqrt{P_1 - P_2}}{\sqrt{S_{GF}}}$$

Flow of Liquid in lb/hr

$$W = 500 C_v \sqrt{(P_1 - P_2) / S_{GF}}$$

Flow of Gases in SCFH ^{1,2}

$$Q = \frac{42.2 C_v \sqrt{(P_1 - P_2)(P_1 + P_2)}}{\sqrt{S_G}}$$

Flow of Gases in SCFH ² (temperature corrected)

$$Q = \frac{963 C_v \sqrt{(P_1 - P_2)(P_1 + P_2)}}{\sqrt{S_G T_F}}$$

Flow of Gases in lb/hr ²

$$W = 3.22 C_v \sqrt{(P_1 - P_2)(P_1 + P_2) / S_{GF}}$$

Flow of Saturated Steam in lb/hr ²

$$W = 2.1 C_v \sqrt{(P_1 - P_2)(P_1 + P_2)}$$

Flow of Super Heated Steam in lb/hr ²

$$W = \frac{2.1 C_v \sqrt{(P_1 - P_2)(P_1 + P_2)}}{(1 + 0.0007 T_s)}$$

Formula Nomenclature

C_v	= Valve coefficient of flow, full open
P₁	= Inlet pressure, psia (14.7+psig)
P₂	= Outlet pressure, psia (14.7+psig)
Q	= Flow, standard cubic feet per hour (SCFH)
S_G	= Specific gravity of liquid
S_{GF}	= Specific gravity of gas
T_F	= Flowing temp °R absolute (460+°F)
T_s	= Superheat in °F
V	= Flow, U.S. gallons per minute (GPM)
W	= Flow, pounds per hour (lb/hr)

Specific Gravity (S_G)

Liquid	S _{gf} @RT Referred to Water
Acetone	0.792
Alcohol	0.792
Benzine	0.902
Gasoline	0.751
Gasoline, nat.	0.680
Kerosene	0.815
Pentane	0.624
Water	1

Gas	S _g @RT Relative to Air
Acetylene	0.897
Air	1.000
Ammonia	0.587
Argon	1.377
Butane	2.070
Carbon Dioxide	1.516
Ethylene	0.967
Helium	0.137
Hydrogen	0.0695
Methane	0.553
Nitrogen	0.966
Oxygen	1.103
Propane	1.562
Sulphur Dioxide	2.208

1. Effect of flowing temperatures of gas flow are minimal for temperatures between 30° and 150°F (-1° to 65°C). Correction should be included if temperatures are higher or lower.
2. Where outlet pressure P₂ is less than 1/2 inlet pressure P₁, the term $\sqrt{(P_1 - P_2)(P_1 + P_2)}$ becomes 0.87 P₁.

PRESSURE DROP CURVES

Theoretical Pressure Drop and Fluid Velocity vs Flow for BuTech Medium and High Pressure Tubing (based on water)

To determine the expected pressure drop per foot of tube length:

1. Select the appropriate curves based on tube I.D.
2. Find system flow rate on X-axis and follow graph vertically until it reaches the solid line corresponding with the tube I.D.
3. Move horizontally in the chart to read the pressure drop per foot on the Y-axis.
4. Multiply this value by the total tube length to obtain total pressure loss.
5. Multiply value from step 4 by the compressibility correction factor from the chart at the right to correct for system pressure above atmospheric.

To determine average fluid velocity, follow the same procedure except use the dashed line.

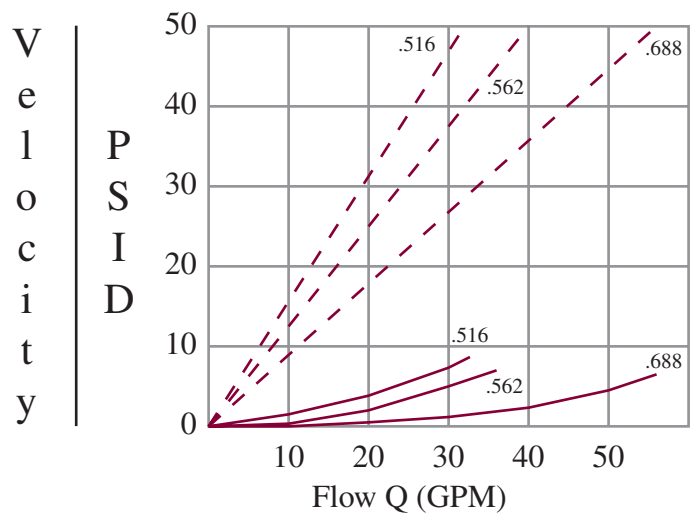
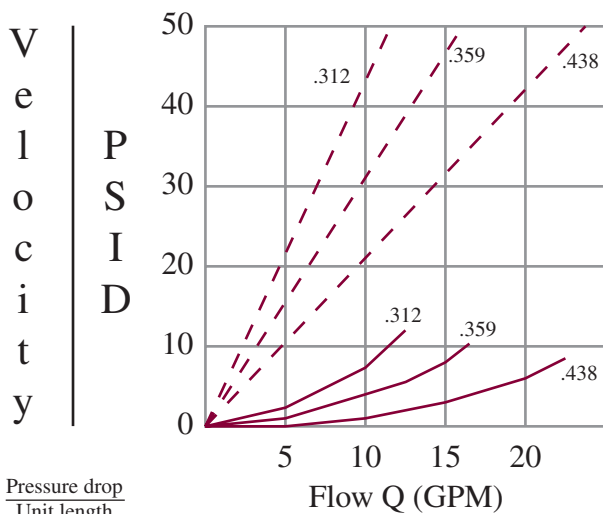
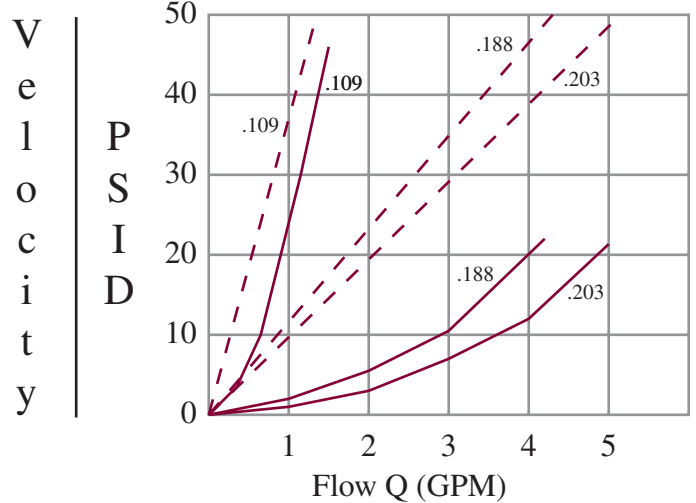
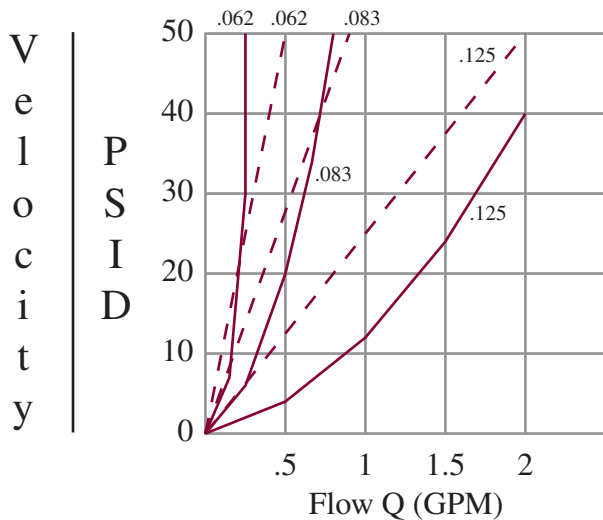
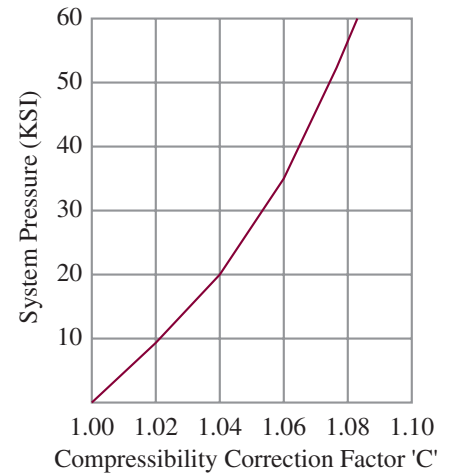

Pressure drop
Unit length
 $\Delta P = \text{psi/ft}$ ———

Velocity:
 $V = \text{ft/sec}$ - - -



PRESSURE VS BEND RADIUS

Allowable Pressure vs Mandrel Radius

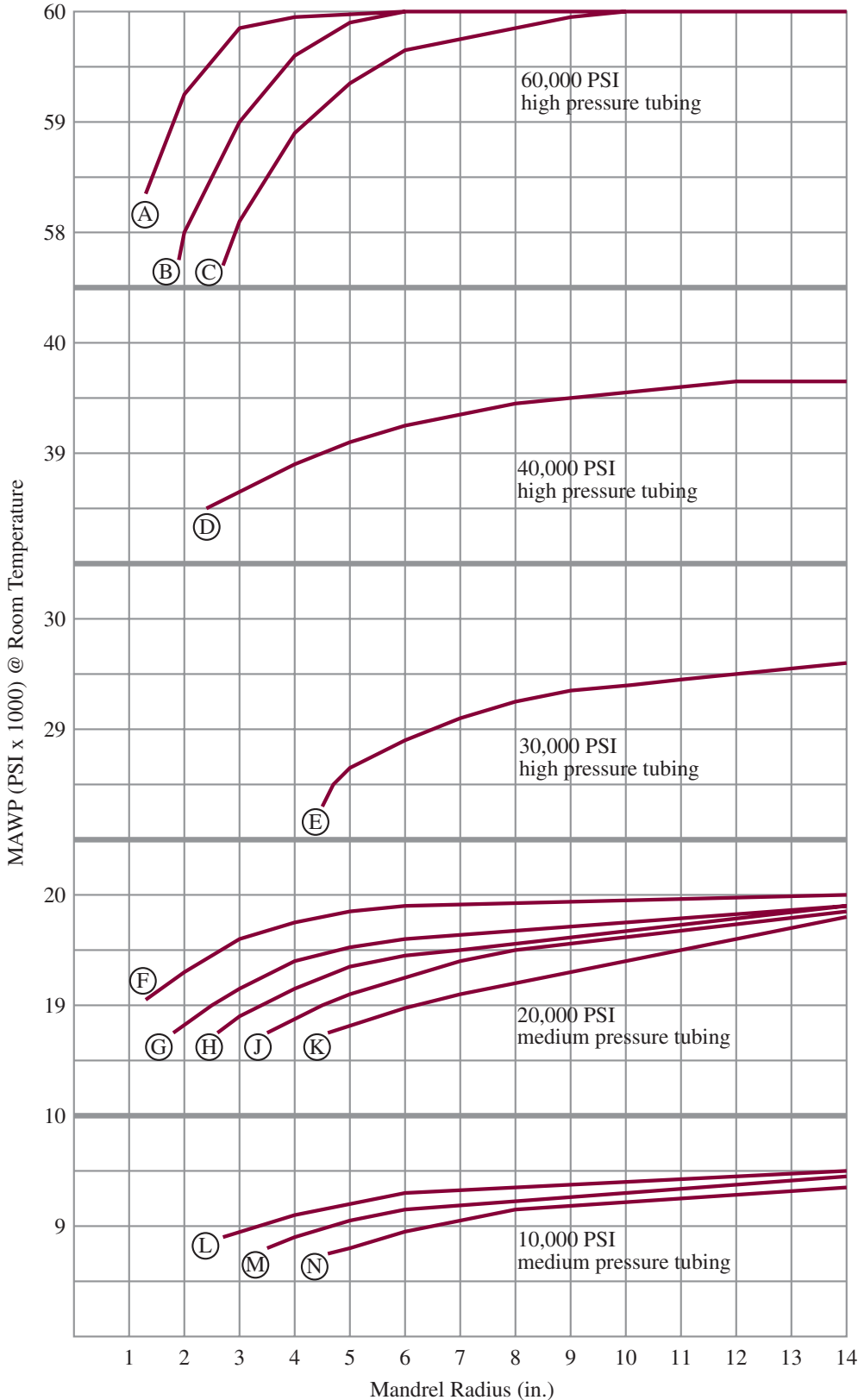

60,000 PSI Tubing

	O.D.	I.D.	Minimum Radius
A	1/4"	.083"	1.25" (31.8 mm)
B	3/8"	.125"	1.75" (44.5 mm)
C	9/16"	.188"	2.625" (66.7 mm)

40,000 PSI Tubing

	O.D.	I.D.	Minimum Radius
D	9/16"	0.250"	2.625" (66.7)

30,000 PSI Tubing

	O.D.	I.D.	Minimum Radius
E	1"	0.438"	4.625" (117.5)

20,000 PSI Tubing

	O.D.	I.D.	Minimum Radius
F	1/4"	0.109"	1.25" (31.8)
G	3/8"	0.203"	1.75" (44.5)
H	9/16"	0.312"	2.625" (66.7)
J	3/4"	0.438"	3.50" (88.9)
K	1"	0.562"	4.625" (117.5)

10,000 PSI Tubing

	O.D.	I.D.	Minimum Radius
L	9/16"	0.359"	2.625" (66.7)
M	3/4"	0.516"	3.50" (88.9)
N	1"	0.688"	4.625" (117.5)

CONVERSION TABLES

PRESSURE		
To convert..	into...	Multiply by:
atm	bar	1.01325
	kg/cm ²	1.0332
	PSI	14.696
	MPa	0.101325
	Pa	101325
bar	atm	0.98692
	kg/cm ²	1.01971
	PSI	14.504
	MPa	0.1
	Pa	100,000
kg/cm ²	atm	0.96784
	bar	0.98067
	PSI	14.223
	MPa	0.098067
	Pa	98066.5
Mpa	atm	9.8692
	bar	10
	kg/cm ²	10.1971
	PSI	145.04
	Pa	1,000,000
Pa	atm	0.000098692
	bar	0.00001
	kg/cm ²	0.0000101971
	PSI	0.00014504
	MPa	0.000001
PSI	atm	0.068046
	bar	0.068947
	kg/cm ²	0.070307
	MPa	0.0068948
	Pa	6894.757

LINEAR		
To convert..	into...	Multiply by:
cm	ft	0.032808
	in	0.3937
	meters	0.01
	microns	10,000
	mm	10
	mm	10
ft	cm	30.48006
	in	12
	meters	0.3048
	microns	304,800
	mm	304.8006
	mm	304.8006
in	cm	2.540005
	ft	0.08333
	meters	0.0254
	microns	25,400
	mm	25.40005
meters	cm	100
	ft	3.28083
	in	39.37
	microns	1,000,000
	mm	1,000
microns	cm	0.0001
	ft	-----
	in	0.00003937
	meters	0.000001
	mm	0.001
mm	cm	0.1
	ft	0.003281
	in	0.03937
	meters	0.001
	microns	1000

VOLUME		
To convert..	into...	Multiply by:
cc	ft ³	0.00003531
	in ³	0.06102
	liter	0.001
	M ³	0.000001
	quart	0.0010568
	U.S. Gallon	0.0002642
ft ³	cc	28,317
	in ³	1728
	liter	28.317
	M ³	0.028317
	quart	29.92
	U.S. Gallon	7.4805
in ³	cc	16.387
	ft ³	0.0005787
	liter	0.016387
	M ³	0.05787
	quart	0.01732
	U.S. Gallon	0.004329
liter	cc	1000.028
	ft ³	0.03531
	in ³	61.023
	M ³	0.001
	quart	1.057
	U.S. Gallon	0.2642
M ³	cc	1,000,000
	ft ³	35.31
	in ³	61,023
	liter	1,000
	quart	1056.8
	U.S. Gallon	264.2
quart	cc	946.25
	ft ³	0.03342
	in ³	57.75
	liter	0.9463
	M ³	0.0009463
	U.S. Gallon	0.25
U.S. Gallon	cc	3,785
	ft ³	0.1337
	in ³	231
	liter	3.785
	M ³	0.003785
	quart	4

FLOW		
To convert..	into...	Multiply by:
cc/min	ft ³ /min	0.0000353145
	gal/min	0.0002642
	in ³ /min	0.061
	lit/min	0.001
ft ³ /min	cc/min	28,320
	gal/min	7.48
	in ³ /min	28.8
	lit/min	28.32
gal/min	cc/min	3,784.8
	ft ³ /min	0.1337
	in ³ /min	231
	lit/min	3.7843
in ³ /min	cc/min	16.39
	ft ³ /min	0.035
	lit/min	0.016
	gal/min	0.004
lit/min	cc/min	1,000
	ft ³ /min	0.03531
	in ³ /min	61.02
	gal/min	0.26418

AREA		
To convert..	into...	Multiply by:
cm ²	ft ²	0.0010764
	in ²	0.155
	m ²	0.0001
	mm ²	100.
	mm ²	100.
ft ²	cm ²	929.0341
	in ²	144
	m ²	0.092903
	mm ²	9,290
	mm ²	9,290
in ²	cm ²	6.4516258
	ft ²	0.006944
	m ²	0.0006451
	mm ²	645.16258
	mm ²	645.16258
m ²	cm ²	10,000
	ft ²	10.76387
	in ²	1,550
	mm ²	1,000,000
	mm ²	1,000,000
mm ²	cm ²	0.01
	ft ²	0.000010764
	in ²	0.00155
	m ²	0.000001
	m ²	0.000001

TEMPERATURE

$$\text{deg F} = (\text{deg C} \times 1.8) + 32$$

$$\text{deg C} = (\text{deg F} - 32) / 1.8$$



